

Surgical Instruments Catalogue



We produce high quality Surgical, Dental, Veterinary, Manicure/Pedicure instruments and scissors of all kinds. We have recognized our production systems and certified as ISO-9001:2008, ISO-EN-13485:2003, and as per the standards of cGMP. We have also got CE marking certification.

We have employed highly technical staff and under their supervision and we made fault free instruments. We use quality steel for our instruments and our instruments are passed through every necessary process of quality control.

We have the policy to provide our worthy customers.

- 1.High Quality Instruments
- 2.Competitive rates
- 3.Fastest possible delivery.



MARK INSTRUMENTS (PVT) LTD.

Manufacturers and Exporters of High Class Surgical, Dental Instruments.

Registered office: 26/4-Zafar Ali Road, Sialkot-Cantt. 51310-Pakistan.
 Tel: +92-52-4292513-19 (2 Lines), Fax: +92-52-4268742 Cell: +92-300-8612950
 E-mail: info@markinstruments.com Web: www.markinstruments.com



SECTION - 01

DIAGNOSTIC INSTRUMENTS



PERCUSSION HAMMERS

Perkussionshämmer Martillos de percusión
 Marteaux-percuteurs Martelli percussori



BUCK
 01-001-185
 18.5 cm



BUCK
 01-002-180
 18 cm



DEJERINE
 01-003-200
 20 cm



DEJERINE
 01-004-200
 20 cm



$\frac{1}{2}$
TAYLOR
 01-005-180 18 cm
 01-006-200 20 cm



WARTENBERG
 01-007-190
 19 cm



TROEMNER
 01-008-245 24.5 cm, 145 g
 01-009-245 24.5 cm, 175 g
 01-010-245 24.5 cm, 235 g
 spare rubber



RABINER
 01-011-255
 25.5 cm
 with needle
 and brush



BERLINER
 01-012-200
 20.0 cm



STETHOSCOPES

Stethoskope Estetoscopios
Stéthoscopes Stetoscopi



PINARD
01-013-180
18 cm



PINARD
01-014-150
15 cm



DUPLEX
01-015-000
super lightweight

Ø 47 mm



DUPLEX-BABY
01-016-000
super lightweight

Ø 37 mm



ANAESTOPHON
01-017-000
super lightweight

Ø 37 mm



INSTRUMENTS

CATHETER FORCEPS

INSTRUMENTS

Katheterzangen
 Pinzas para sondes
 Pinzas para catéteres
 Pinze per cannule



MAGILL
 01-018-170 17 cm
 01-019-200 20 cm
 01-020-250 25 cm



TONGUE DEPRESSORS
 01-021-000



BUCHWALD
 01-022-180
 18 cm



BRUENINGS
 01-023-190
 19 cm



COLLIN
 01-024-160 16 cm
 01-025-180 18 cm



01-027-000
 pair

YOUNG
 01-026-170
 17 cm

DIAGNOSTIC SETS

Diagnostik-Bestestecke Juegos para diagnóstico
Trousse à diagnostic Astucci per diagnostica



OTOSCOPE SET (color available)
Pi01-035-000

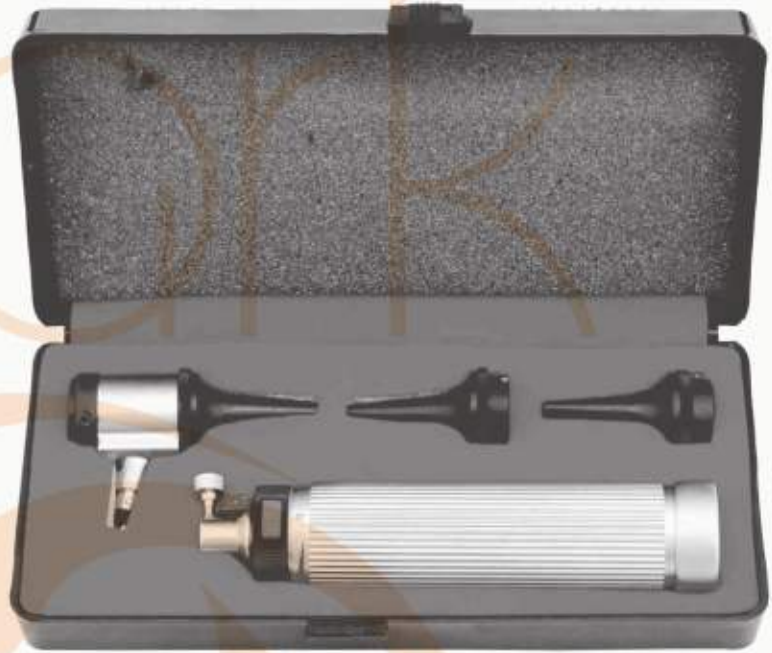

OTOSCOPE SET
Pi01-036-000



MINI OTOSCOPE SET
Pi01-037-000



DIAGNOSTIC SET
Pi01-038-000



DIAGNOSTIC SET
Pi01-039-000

DIAGNOSTIC SETS

Diagnostik-Bestestecke Juegos para diagnóstico
Trousse à diagnostic Astucci per diagnostica



GUEDEL-NEGUS

01-033-000
with three laryngoscope
blades No. 1 to 3
complete, in case.

01-034-000
With four laryngoscope
blades No. 1 to 4
complete, in case.

01-038-004
for men
working length
175 mm



01-035-001
for children
working length
70 mm



01-036-002
for adolescents
working length
90 mm



01-037-003
for women
working length
110 mm



MCINTOSH

01-039-000
with three laryngoscope
blades No. 1 to 3
complete, in case.

01-040-000
With five laryngoscope
blades No. 1 to 5
complete, in case.

01-045-005
for men
working length
135 mm



01-041-001
for babies
working length
55 mm



01-042-002
for children
working length
75 mm



01-043-003
for adolescents
working length
90 mm



01-044-004
for women
working length
110 mm



DIAGNOSTIC SETS

Diagnostik-Bestestecke Juegos para diagnóstico
Trousse à diagnostic Astucci per diagnostica



01-049-000

MILLER-BABY
01-046-000

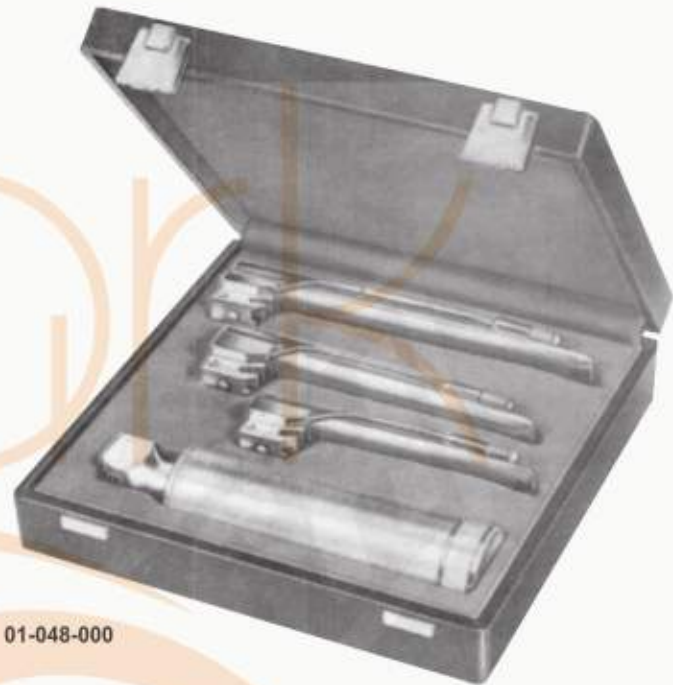

01-048-000

01-046-000

Laryngoscope set, baby and infant Consisting of

- 01-047-000 Battery Handle without Battery
- 01-049-000 Miller baby blade (working length 55 mm)
- 01-050-001 Ditto, (working length 80 mm)

01-047-000

Miller Laryngoscope set,

- 01-047-000 Battery Handle, without Battery
- 01-050-001 Blade (working length 80 mm)
- 01-051-002 Ditto, (working length 130 mm)
- 01-052-003 Ditto, (working length 170 mm)

Miller laryngoscope blades,

- 01-049-000 working length 55 mm
- 01-050-001 working length 80 mm
- 01-051-002 working length 130 mm
- 01-052-003 working length 170 mm
- 01-053-004 working length 180 mm



01-049-000



01-050-001



01-051-002



01-052-003



01-053-004

INSTRUMENTS

LARYNGOSCOPE DIAGNOSTIC SETS

Laryngoskope Diagnostik-Bestestecke
Laryngoscopes Trousses à diagnostic

Laringoscopios Juegos para diagnóstico
Laringoscopi Astucci per diagnostica

CONVENTIONAL SET

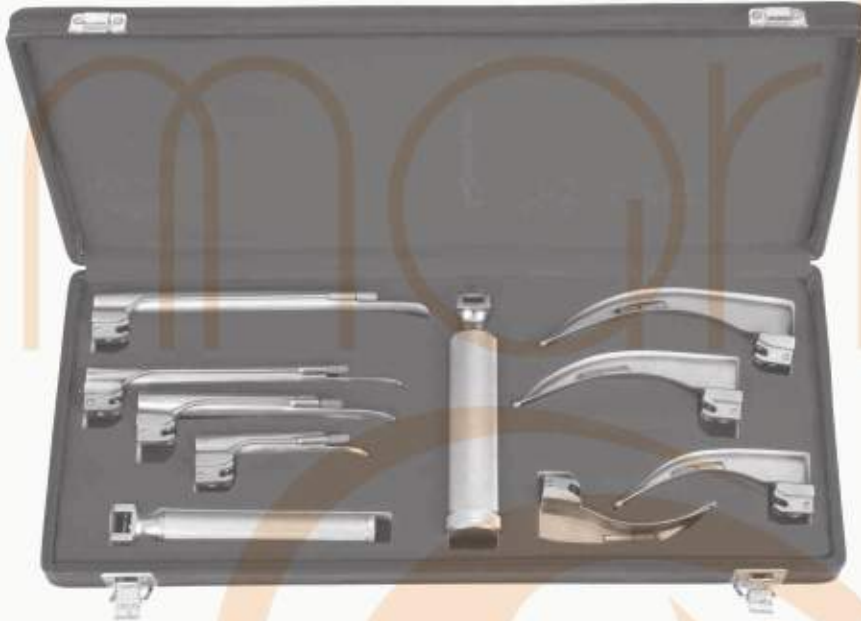

CONVENTIONAL SET
01-054-000
MAC + MILLER COMBINED
Double Set of 10 Pcs.
4 Miller Blades
4 Mac Blades
1 Handle Small
1 Handle Medium

FIBEROPTIC SET

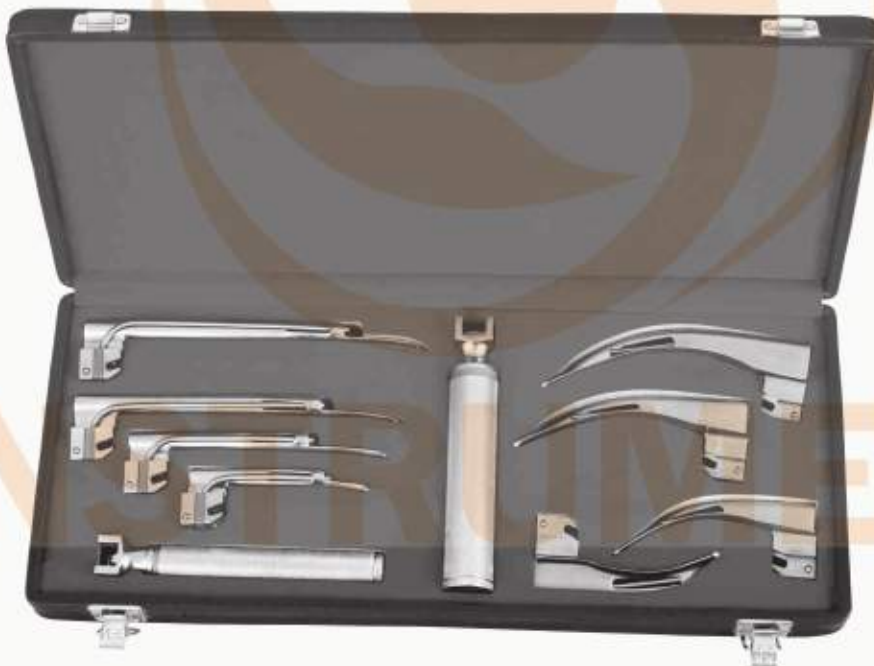

MAC + MILLER COMBINED SET
01-055-000
Double Set of 10 Pcs.
4 Miller Blades
4 Mac Blades
1 Handle Small
1 Handle Medium

LARYNGOSCOPE DIAGNOSTIC SETS

Laryngoskope Diagnostik-Bestestecke
Laryngoscopes Trousses à diagnostic

Laringoscopios Juegos para diagnóstico
Laringoscopi Astucci per diagnostica

FIBEROPTIC SETS



MAC SET
01-056-000
Set of 5 pcs.



MILLER SET
01-057-000
Set of 5 pcs.

DISPOSABLE LARYNGOSCOPE SETS



MAC DISPOSABLE SET
01-058-000
Set of 4 Blade + 1 Handle



MILLER DISPOSABLE SET
01-059-000
Set of 4 Blade + 1 Handle



MÖLTGEN
01-060-000



CARROLL
01-061-145
14.5 cm



VERNIER
01-062-225
22.5 cm



CASTROVIEJO-EPKER
01-063-180
18 cm
Measuring range
40 mm



CASTROVIEJO
01-064-080
8 cm
Measuring range
15 mm



CASTROVIEJO
01-065-080
8 cm
Measuring range
20 mm



CASTROVIEJO
01-066-080
8 cm
Measuring range
20 mm

SUCTION TUBES

Saugrohre Tubos de aspiración
Canules d'aspiration Tubi per aspirazione



COUPLAND
01-067-000

BYRD
01-068-000 1.5 mm
01-069-000 2.5 mm
01-070-000 3.5 mm

COOLEY
01-071-330
33.0 cm

COOLEY
01-072-350
35 cm

COOLEY
01-073-300
30.0 cm

COOLEY
01-074-310
31.0 cm

SUCTION TUBES

Saugrohre Tubos de aspiracion
Canules d'aspiration Tubi per aspirazione



ADSON
01-075-150
4 mm Ø 15 cm



ADSON
01-076-150 4 mm Ø 15 cm
01-077-200 4 mm Ø 20 cm
01-078-200 5 mm Ø 20 cm



PLESTER
01-079-000 1.5 mm Ø
01-080-000 2.0 mm Ø
01-081-000 2.5 mm Ø
01-082-000 3.0 mm Ø



FRAZIER-FERGUSON
01-083-000 6 Fr.
01-084-000 7 Fr.
01-085-000 9 Fr.
01-086-000 10 Fr.
01-087-000 11 Fr.
11.4 cm



FRAZIER
19 cm
01-088-000 6 Fr.
01-089-000 7 Fr.
01-090-000 9 Fr.
01-091-000 11 Fr.



FRAZIER 30°
18 cm
01-092-000 6 Fr.
01-093-000 7 Fr.
01-094-000 8 Fr.
01-095-000 9 Fr.
01-096-000 10 Fr.
01-097-000 11 Fr.
01-098-000 12 Fr.
01-099-000 15 Fr.



FRAZIER 45°
18 cm
01-100-000 6 Fr.
01-101-000 7 Fr.
01-102-000 8 Fr.
01-103-000 9 Fr.
01-104-000 10 Fr.
01-105-000 11 Fr.
01-106-000 12 Fr.

SUCTION TUBES / TROCARS

Saugrohre, Trokare

Tubos de aspiracion, Trócares

Canules d'aspiration, Trocarts

Tubi per aspirazione, Trequarti



YANKAUER
01-107-270
27 cm



ANDREWS-PYNCHON
01-108-235
23.5 cm



POOLE
01-109-220
22 cm
Straight, 30FR



POOLE
01-110-220
22 cm
Curved, 23FR



LUER
01-111-000
Luer lock adapter



With 4 trocar tips
1,7, 3,0,
4,5 + 6,0 mm Ø

UNIVERSAL
01-112-140
14 cm



Complete
1.8 mm Ø

LICHTWITZ
01-113-185
18.5 cm
antrum trocar



TROCARS

Trokare Trócares
Trocarts Trequarti



ROHERTS

With stopcock and drain

- 01-114-185 3 mm x 80 mm 18.5 cm
- 01-115-185 4 mm x 80 mm 18.5 cm
- 01-116-185 5 mm x 80 mm 18.5 cm
- 01-117-185 6 mm x 80 mm 18.5 cm



ACITES

- 01-118-170 3.0 mm x 80 mm 17.0 cm
- 01-119-170 4.0 mm x 80 mm 17.0 cm
- 01-120-170 5.0 mm x 80 mm 17.0 cm



BUELAU

- inside diam.
- 01-121-000 7.0 mm
- 01-122-000 9.0 mm



BUELAU

- Outside diam
- 01-123-000 08 mm
- 01-124-000 10 mm



BILLROTH

- inside diam. Outside diam
- 01-125-000 5.0 mm 6.0 mm



With 1 blunt
cannulae, 4.0 mm
outside diam.

FLEURANT

- inside diam. Outside diam
- 01-126-000 4.0 mm 5.0 mm

INSTRUMENTS

TROCARS

Trokare Trócares
Trocarts Tre quarti



OCHSNER
01-127-140 14.0 cm
01-128-140 14.0 cm
01-129-140 14.0 cm
4.0 mm x 100 mm
5.5 mm x 100 mm
6.5 mm x 100 mm



LICHTWITZ
01-130-000
1.8 mm



PIERCE
01-131-000
4.0 mm



KRAUSE
01-132-000
5.5 mm



COAKLEY
01-133-000
2.25 mm



LANDAU
01-134-000
2.0 mm



UNIVERSAL
01-135-000
Set of 3 Pieces
01-136-000
Set of 4 Pieces



NELSON
21 cm



DISSECTING KITS

Diagnostik-bestecke

Diagnostic Setts

Estuches de diagnostico

Combinazioni per diagnostica

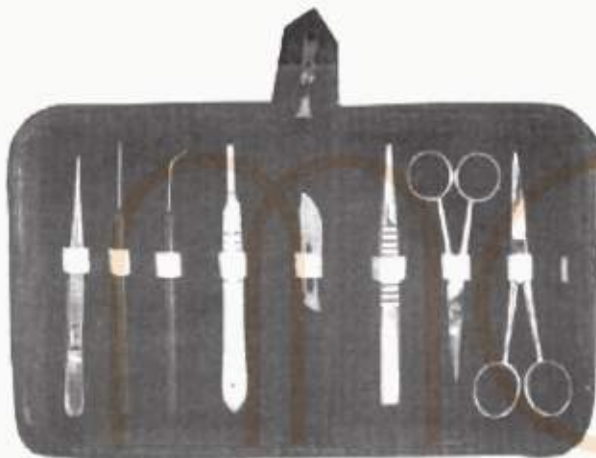

01-141-000

Set of 9 Pcs.

- Dissecting Forceps 11.5cms Sharp Point.
- Teasing needle Sharp STR.
- B.P Handle No.4.
- Teasing Needle Sharp Angular.
- Blade No. 22.
- Thumb Forcep T.O.E 13cms.
- Dissecting Scissor STR 11.5cms.
- Dissecting Scissor STR 13cms.
- Zipper Case Inside Red Velvet.

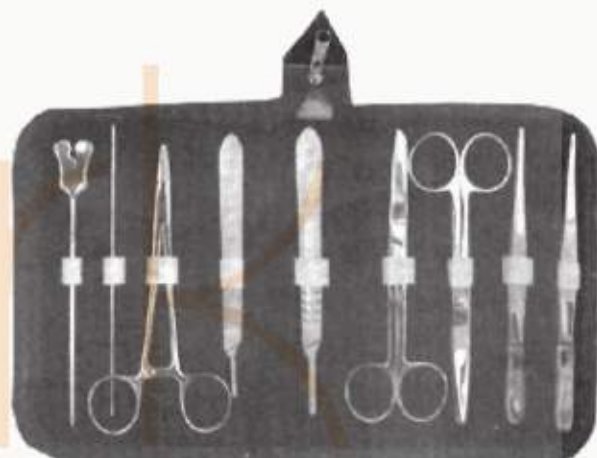

01-142-000

Set of 10 Pcs.

- Grooved Director with Tongue Tie 14cms.
- Probe Double 14cms.
- Mayo Hegar Needle Holder 14cms.
- B.P Handle No.3
- B.P Handle No.4
- Dressing Scissor 14cms S/B STR.
- Dressing Scissor 14cms S/B CVD.
- Dressing Forcep 1x2 teeth 14cms.
- Dressing Forcep Serrated 14cms.
- Zipper Case Inside Red Velvet.



01-143-000

Set of 10 Pcs.

- Probe Double 13cms.
- 2PCS. Scalpel S.S.
- Grooved Director With Tongue Tie 13cms
- Mayo Hegar Needle Holder 13cms.
- Dissecting Forcep 13cms 1x2 Teeth.
- Dressing Forcep 13cms Serrated.
- Dressing Scissor 13cms S/B STR.
- Dressing Scissor 13cms S/B CVD.
- Zipper Case Inside Red Velvet.



01-144-000

Set of 10 Pcs.

- Blow Pipe.
- 3PCS Scalpel.
- Dissecting Forcep 13cms.
- Grooved Director With Tongue Tie 13cms
- Triple Chain Hook.
- Dressing Scissor Probe Pointed 13cms.
- Probe Double 13 cms.
- Zipper Case Inside Red Velvet.

SECTION - 02

SCALPEL HOLDERS / AMPUTATION KNIVES





INSTRUMENTS

SCALPEL HANDLES

Skalpgriffe
Mangos de bisturíes

Manches pour bistouris
Manici per bisturi



SCALPEL HANDLE #3
02-001-120
12.75 cm
10, 11, 12, 15



SCALPEL HANDLE #3 GRADUATED
02-002-120
12.75 cm
10, 11, 12, 15



SCALPEL HANDLE #7
02-003-160
16 cm



SCALPEL HANDLE #7
02-004-165
16.5 cm
10, 11, 12, 15



SCALPEL HANDLE #3 3L LONG
02-005-210
21 cm
10, 11, 12, 15



SCALPEL HANDLE #3 / LONG ANGLED
02-006-200
20.25 cm
10, 11, 12, 15



INSTRUMENTS

SCALPEL HANDLES

Skalpgriffe
Mangos de bisturíes

Manches pour bistouris
Manici per bisturi



SCALPEL PLASTIC HANDLE
02-007-05
5



SCALPEL HANDLE
02-008-155
15.5 cm



CORWIN ROUND
02-009-150
15.25 cm
10, 11, 12, 15



SCALPEL HANDLE
02-010-140
14 cm



SCALPEL HANDLE #4
02-011-120
12.75 cm
20, 22, 25



SCALPEL HANDLE
02-012-210
21 cm



COLLIN
02-013-09
9



Fig. 10



Fig. 11



Fig. 12



Fig. 15



Fig. 20



Fig. 22



SCALPEL HANDLES

Skalpgriffe

Mangos de bisturís

Manches pour bistouris

Manici per bisturi



**SCALPEL
PLASTIC
HANDLE**
02-014-06
6

**SCALPEL
HANDLE**
4L long
02-015-210
21 cm

**SCALPEL
HANDLE**
02-016-115
11.5 cm

**SCALPEL
HANDLE**
02-017-127
12.7 cm

**SCALPEL
HANDLE**
02-018-110
11 cm

**SCALPEL
HANDLE**
02-019-127
12.7 cm

**SCALPEL
HANDLE**
02-020-135
13.5 cm

SCALPEL HANDLES

Skalpgriffe
 Mangos de bisturís

Manches pour bistouris
 Manici per bisturi



TROUTMAN-CHRIS
 02-021-090
 9 cm



TROUTMAN-CHRIS
 02-022-090
 9 cm



**BLADE HOLDER
 BLADE BREAKER**
 02-023-110
 11 cm



CASTROVIEJO
 02-024-130
 13 cm

INSTRUMENTS

DISSECTING KNIVES

Anatomische skalpelle
 Bisturías para disección

Bistouris à dissection
 Bisturi para dissezione



DIEFFENBACH
 16 cm



Fig. 1
02-025-160
 16 cm



Fig. 2
02-026-160
 16 cm



Fig. 3
02-027-160
 16 cm



Fig. 4
02-028-160
 16 cm



Fig. 5
02-029-160
 16 cm



Fig. 6
02-030-160
 16 cm



Fig. 7
02-031-160
 16 cm



Fig. 8
02-032-160
 16 cm



Fig. 9
02-033-160
 16 cm



Fig. 15
02-034-160
 16 cm



Fig. 16
02-035-160
 16 cm

DISSECTING KNIVES

Anatomische skalpelle
Bisturías para disección

Bistouris à dissection
Bisturi para dissezione



COLLIN
14.5 cm



Fig. 1
02-036-145
14.5 cm



Fig. 2
02-037-145
14.5 cm



Fig. 3
02-038-145
14.5 cm



Fig. 4
02-039-145
14.5 cm



Fig. 5
02-040-145
14.5 cm



Fig. 6
02-041-145
14.5 cm



DIEFFENBACH
13.5 cm



Fig. 1
02-042-135
13.5 cm



Fig. 2
02-043-135
13.5 cm



Fig. 3
02-044-135
13.5 cm



Fig. 4
02-045-135
13.5 cm



Fig. 5
02-046-135
13.5 cm



Fig. 6
02-047-135
13.5 cm



Fig. 7
02-048-135
13.5 cm



Fig. 8
02-049-135
13.5 cm



Fig. 9
02-050-135
13.5 cm



Fig. 10
02-051-135
13.5 cm

DISSECTING KNIVES

Anatomische skalpelle
 Bisturías para disección

Bistouris à dissection
 Bisturi para dissezione



02-055-170
 17 cm



Fig. 1
02-052-170
 17 cm



Fig. 3
02-053-170
 17 cm



Fig. 5
02-054-170
 17 cm



Fig. 7
02-055-170
 17 cm



Fig. 9
02-056-170
 17 cm



Fig. 10
02-057-170
 17 cm



Fig. 12
02-058-170
 17 cm



Fig. 14
02-059-170
 17 cm



Fig. 16
02-060-170
 17 cm



Fig. 18
02-061-170
 17 cm

DISSECTING KNIVES

Anatomische skalpelle
Bisturíes para disección

Bistouris à dissection
Bisturi para dissezione



DISSECTING KNIFE 15 cm with metal handle



02-062-150

15 cm

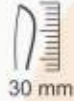

30 mm



02-063-150

15 cm



36 mm



02-064-155

15.5 cm



40 mm



02-065-160

16 cm



45 mm



02-066-160

16 cm



50 mm



02-067-150

15 cm



27 mm



02-068-150

15 cm



35 mm



02-069-160

16 cm



40 mm



02-070-160

16 cm

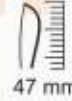

47 mm



02-071-170

17 cm

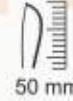

50 mm

DISSECTING KNIVES

Anatomische skalpelle
Bisturías para disección

Bistouris à dissection
Bisturi para dissezione



ESMARCH
02-072-180
18.0 cm



COLLIN
02-073-130 13 cm
02-074-160 16 cm
02-075-190 19 cm
02-076-220 22 cm
02-077-280 28 cm



CATLIN
02-078-160 16 cm
02-079-190 19 cm
02-080-220 22 cm



LISTON
02-081-170 17 cm
02-082-190 19 cm
02-083-220 22 cm



LANGENBECK
02-084-120
12 cm



DIEFFENBACH
02-085-130
13 cm



DIEFFENBACH
02-086-130
13 cm



SIMON
02-087-235
23.5 cm



Fig.1
02-088-235



Fig. 2
02-089-235



Fig. 3
02-090-235



Fig. 4
02-091-235

INSTRUMENTS



DISSECTING KNIVES

Anatomische skalpelle
Bisturías para disección

Bistouris à dissection
Bisturi para dissezione

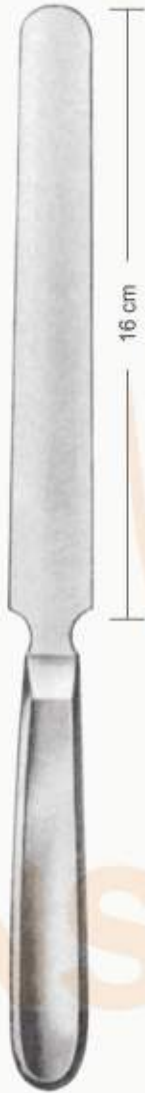

VIRCHOW
02-092-260
26 cm



VIRCHOW
02-093-335
33.5 cm



VIRCHOW
02-094-380
38 cm

AMPUTATION KNIVES & RESECTION SAWS

Amputationsmesser, Cuchillos para amputación
 Couteaux à amputation, coltelli per amputazione

Resektionsmesser, Cuchillos para resección
 Couteaux à résection, Coltelli per resezione



GIGLI SAW
 02-095-000 30 mm
 02-096-000 40 mm
 02-097-000 50 mm
 02-098-000 70 mm
 stainless



GIGLI HANDLE
 02-099-000



**ENGEL
 PLASTER SAW**
 02-100-155
 15.5 cm



CHARRIERE
 02-101-250 25 cm
 02-102-270 27 cm
 Double saw



LANGENBERCK
 02-103-235
 23.5 cm
 length of blade
 115 mm, 4 1/2"



CHARRIERE
 02-104-270 27 cm
 02-105-300 30 cm



CHARRIERE
 02-106-350
 35 cm



SATTERLEE
 02-107-310
 31 cm

SECTION - 03

GENERAL OPERATING & MICRO SCISSORS





OPERATING SCISSORS

Chirurgische scheren
Tijeras Para Cirugia

Ciseaux à chirurgie
Forbici per chirurgia



STANDARD STRAIGHT

03-001-105	10.5 cm
03-002-115	11.5 cm
03-003-130	13.0 cm
03-004-140	14.0 cm
03-005-150	15.0 cm
03-006-165	16.5 cm
03-007-170	17.0 cm
03-008-180	18.0 cm
03-009-200	20.0 cm



STANDARD CURVED

03-010-105	10.5 cm
03-011-115	11.5 cm
03-012-130	13.0 cm
03-013-140	14.0 cm
03-014-150	15.0 cm
03-015-165	16.5 cm
03-016-170	17.0 cm
03-017-180	18.0 cm
03-018-200	20.0 cm



STANDARD STRAIGHT

03-019-105	10.5 cm
03-020-115	11.5 cm
03-021-130	13.0 cm
03-022-140	14.0 cm
03-023-150	15.0 cm
03-024-165	16.5 cm
03-025-170	17.0 cm
03-026-180	18.0 cm
03-027-200	20.0 cm

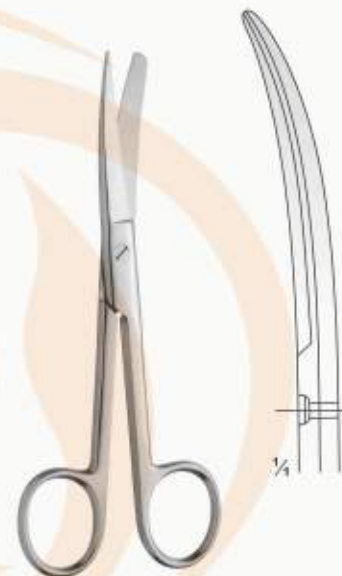

STANDARD CURVED

03-028-105	10.5 cm
03-029-115	11.5 cm
03-030-130	13.0 cm
03-031-140	14.0 cm
03-032-150	15.0 cm
03-033-165	16.5 cm
03-034-170	17.0 cm
03-035-180	18.0 cm
03-036-200	20.0 cm

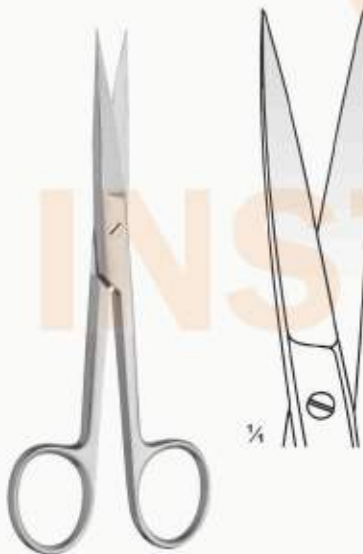

STANDARD STRAIGHT

03-037-105	10.5 cm
03-038-115	11.5 cm
03-039-130	13.0 cm
03-040-140	14.0 cm
03-041-150	15.0 cm
03-042-165	16.5 cm
03-043-170	17.0 cm
03-044-180	18.0 cm
03-045-200	20.0 cm



STANDARD CURVED

03-046-105	10.5 cm
03-047-115	11.5 cm
03-048-130	13.0 cm
03-049-140	14.0 cm
03-050-150	15.0 cm
03-051-165	16.5 cm
03-052-170	17.0 cm
03-053-180	18.0 cm
03-054-200	20.0 cm

OPERATING SCISSORS

Chirurgische scheren
 Tijeras Para Cirugia

Ciseaux à chirurgie
 Forbici per chirurgia



GRAZIL STRAIGHT
 03-055-130 13.0 cm
 03-056-145 14.5 cm



GRAZIL CURVED
 03-057-130 13.0 cm
 03-058-145 14.5 cm



GRAZIL STRAIGHT
 03-059-130 13.0 cm
 03-060-145 14.5 cm



GRAZIL CURVED
 03-061-130 13.0 cm
 03-062-145 14.5 cm



GRAZIL STRAIGHT
 03-063-130 13.0 cm
 03-064-145 14.5 cm



GRAZIL CURVED
 03-065-130 13.0 cm
 03-066-145 14.5 cm

OPERATING SCISSORS

Chirurgische scheren
Tijeras Para Cirugia

Ciseaux à chirurgie
Forbici per chirurgia



MAYO

- 03-067-145 14.5 cm
- 03-068-150 15.0 cm
- 03-069-170 17.0 cm
- 03-070-195 19.5 cm
- 03-071-210 21.0 cm
- 03-072-230 23.0 cm
- 03-073-280 28.0 cm

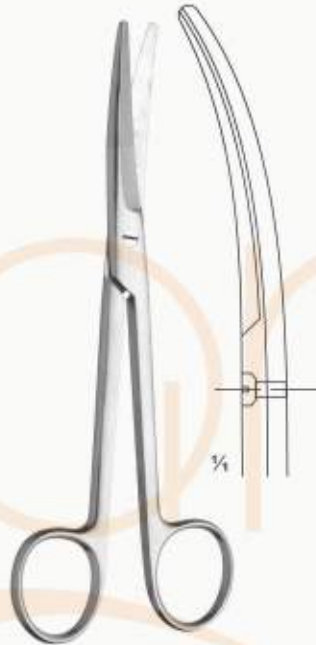

MAYO

- 03-074-145 14.5 cm
- 03-075-150 15.0 cm
- 03-076-170 17.0 cm
- 03-077-195 19.5 cm
- 03-078-210 21.0 cm
- 03-079-230 23.0 cm
- 03-080-280 28.0 cm



MAYO-STILLE

- 03-081-150 15.0 cm
- 03-082-170 17.0 cm
- 03-083-195 19.5 cm
- 03-084-210 21.0 cm



MAYO-STILLE

- 03-085-150 15.0 cm
- 03-086-170 17.0 cm
- 03-087-195 19.5 cm
- 03-088-210 21.0 cm

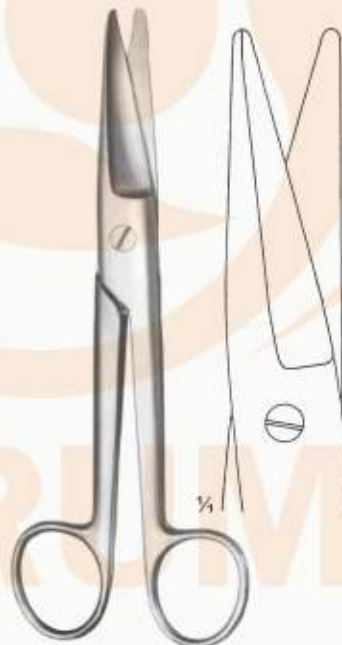

MAYO-NOBLE

- 03-089-170
17.0 cm
Straight



MAYO-NOBLE

- 03-090-170
17.0 cm
Curved



OPERATING SCISSORS

Chirurgische scheren
Tijeras Para Cirugia

Ciseaux à chirurgie
Forbici per chirurgia



METZENBAUM
Blunt / Blunt
Straight



METZENBAUM
Blunt / Blunt
Curved

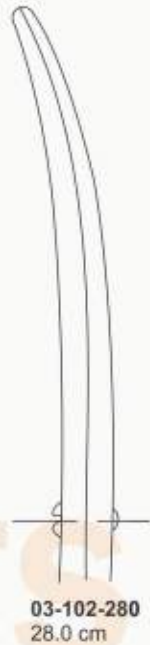

OPERATING SCISSORS

Chirurgische scheren
Tijeras Para Cirugia

Ciseaux à chirurgie
Forbici per chirurgia



INCISION
03-103-130 13.0 cm
03-104-145 14.5 cm



INCISION
03-105-155
15.5 cm



RICHTER
03-106-145
14.5 cm



FERGUSSON
03-107-140 14.0 cm
03-108-165 16.5 cm
03-109-180 18.0 cm



DEAVER
03-110-140
14.0 cm

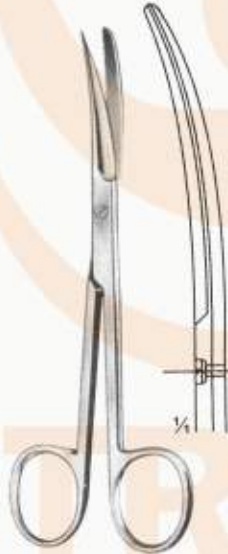

DEAVER
03-111-140
14.0 cm



METZENBAUM
Sharp/Sharp
03-112-145 14.5 cm
03-113-180 18.0 cm
03-114-200 20.0 cm
03-115-230 23.0 cm
03-116-250 25.0 cm
03-117-280 28.0 cm
03-118-300 30.0 cm

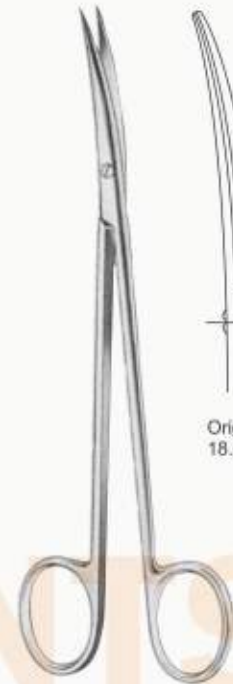

METZENBAUM
Sharp/Sharp
03-119-145 14.5 cm
03-120-180 18.0 cm
03-121-200 20.0 cm
03-122-230 23.0 cm
03-123-250 25.0 cm
03-124-280 28.0 cm
03-125-300 30.0 cm



OPERATING SCISSORS

Chirurgische scheren
Tijeras Para Cirugia

Ciseaux à chirurgie
Forbici per chirurgia



METZENBAUM
Sharp/Blunt

- 03-126-145 14.5 cm
- 03-127-180 18.0 cm
- 03-128-200 20.0 cm
- 03-129-230 23.0 cm
- 03-130-250 25.0 cm
- 03-131-280 28.0 cm
- 03-132-300 30.0 cm

METZENBAUM
Sharp/Blunt

- 03-133-180 14.5 cm
- 03-134-180 18.0 cm
- 03-135-200 20.0 cm
- 03-136-230 23.0 cm
- 03-137-250 25.0 cm
- 03-138-280 28.0 cm
- 03-139-300 30.0 cm

METZENBAUM-BABY
03-140-115
11.5 cm

METZENBAUM-BABY
03-141-115
11.5 cm

LEXER
03-142-160
16.0 cm

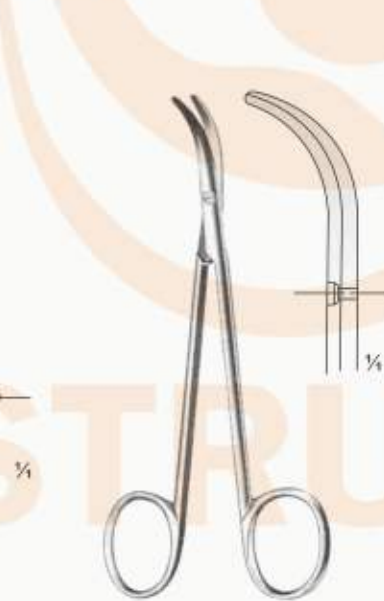

LEXER
03-143-160
16.0 cm

FOMON
03-144-135
13.5 cm

LEXER-BABY
03-145-100
10.0 cm

LEXER-BABY
03-146-100
10.0 cm

OPERATING SCISSORS

Chirurgische scheren
Tijeras Para Cirugia

Ciseaux à chirurgie
Forbici per chirurgia



Plastic

JOSEPH
03-147-140
14.0 cm



JOSEPH
03-148-140
14.0 cm



Plastic

KILNER
03-149-120 12.0 cm
03-150-150 15.0 cm
03-151-180 18.0 cm
03-152-200 20.0 cm

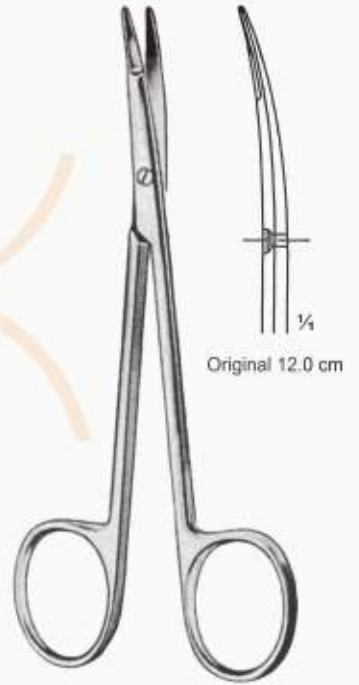

KILNER
03-153-120 12.0 cm
03-154-150 15.0 cm
03-155-180 18.0 cm
03-156-200 20.0 cm



REYNOLDS
03-157-150 15.0 cm
03-158-180 18.0 cm



REYNOLDS
03-159-150 15.0 cm
03-160-180 18.0 cm



SIMS
03-161-200 20.0 cm
03-162-230 23.0 cm
Straight



03-163-200 20.0 cm
03-164-230 23.0 cm



03-165-200 20.0 cm
03-166-230 23.0 cm



SIMS
03-167-200 20.0 cm
03-168-230 23.0 cm
Curved



03-169-200 20.0 cm
03-170-230 23.0 cm



03-171-200 20.0 cm
03-172-230 23.0 cm

OPERATING SCISSORS

Chirurgische scheren
Tijeras Para Cirugia

Ciseaux à chirurgie
Forbici per chirurgia



DUBOIS
03-173-270
27.0 cm



DUBOIS
03-174-270
27.0 cm



KILLNER



03-175-115
11.5 cm
Straight,
sharp/sharp



LITTLER



03-176-115 03-177-140
11.5 cm 14 cm
Curved, Curved,
sharp/sharp sharp/sharp



STRABISMUS



03-178-115
11.5 cm
Curved, blunt/blunt
03-179-115
11.5 cm
Straight, blunt/blunt



IRIS



03-180-090 09 cm Straight
03-181-105 10.5 cm Straight
03-182-110 11 cm Straight
03-183-090 09 cm Curved
03-184-105 10 cm Curved
03-185-115 11.5 cm Curved

OPERATING SCISSORS

Chirurgische scheren
Tijeras Para Cirugia

Ciseaux à chirurgie
Forbici per chirurgia

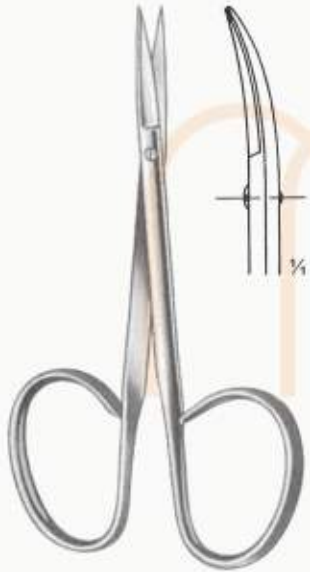

Straight 03-186-100 10.0 cm
Curved 03-187-100 10.0 cm



Straight 03-188-100 10.0 cm
Curved 03-189-100 10.0 cm



03-190-095
9.5 cm
Curved-Ribbon
Handles blunt/blunt

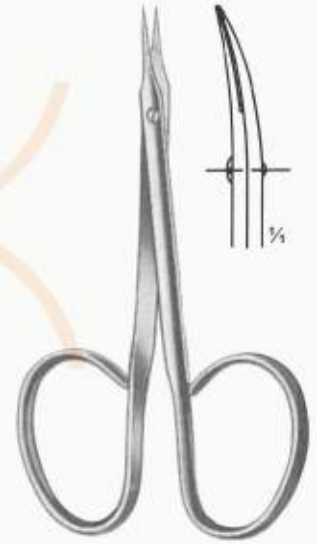

Straight 03-191-095 9.5 cm
Curved 03-192-095 9.5 cm

TENOTOMY

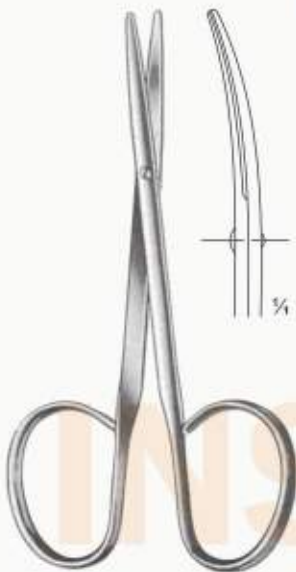

Straight 03-193-100 10.0 cm
Curved 03-194-100 10.0 cm



Straight 03-195-095 9.5 cm
Curved 03-196-095 9.5 cm



TENOTOMY-STEVENS

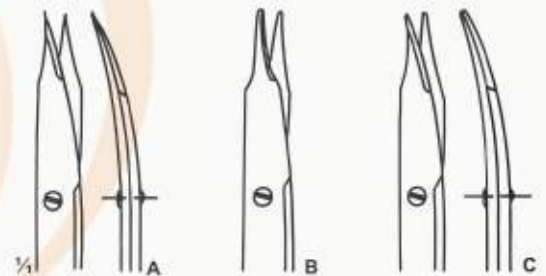

Fig.	Item	Description	Tip
A	03-197-115	11.5 cm Curved	Sharp/Sharp
B	03-198-105	10.5 cm Straight	Blunt/Blunt
B	03-199-115	11.5 cm Straight	Blunt/Blunt
C	03-200-105	10.5 cm Curved	Blunt/Blunt
C	03-201-115	11.5 cm Curved	Blunt/Blunt
C	03-202-115	11.5 cm Curved	Blunt/Blunt
C	03-203-145	14.5 cm Curved Supercut	Blunt/Blunt

OPERATING SCISSORS

Chirurgische scheren
 Tijeras Para Cirugia

Ciseaux à chirurgie
 Forbici per chirurgia



GOLDMAN-FOX
 03-204-130
 13.0 cm

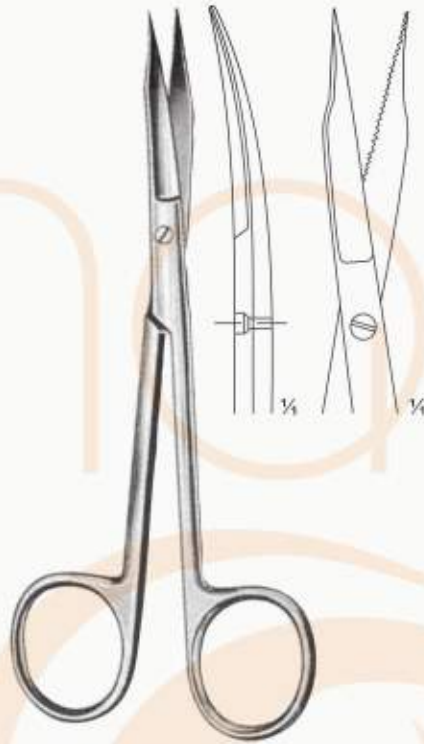

GOLDMAN-FOX
 03-205-130
 13.0 cm



LOCKLIN
 03-206-165
 16.5 cm



LOCKLIN
 03-207-165
 16.5 cm



DEAN-DELICATE
 03-208-170
 17.0 cm

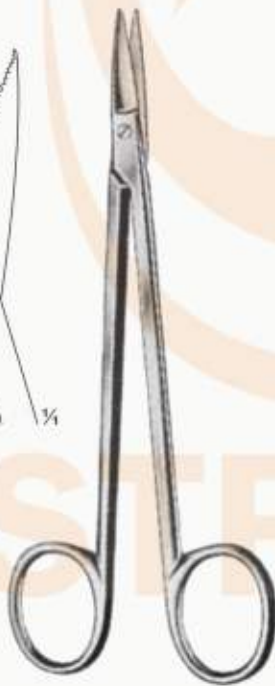

QUINBY
 03-209-120
 12.0 cm

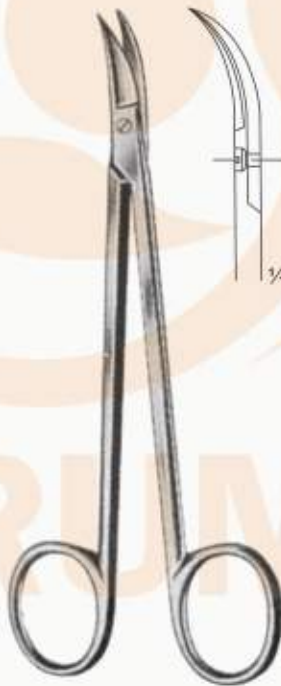

QUINBY
 03-210-120
 12.0 cm

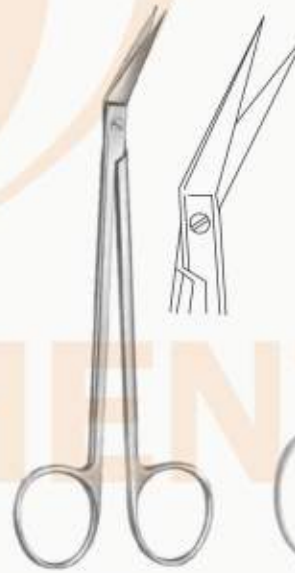

IRIS
 03-211-110
 11cm



KNAPP IRIS
 03-212-102 10.2 cm Straight.
 03-213-102 10.2 cm Curved

OPERATING SCISSORS

Chirurgische scheren
Tijeras Para Cirugia

Ciseaux à chirurgie
Forbici per chirurgia



HEGEMANN-DIETRICH

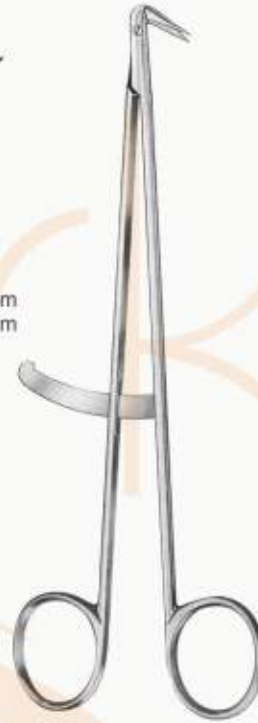
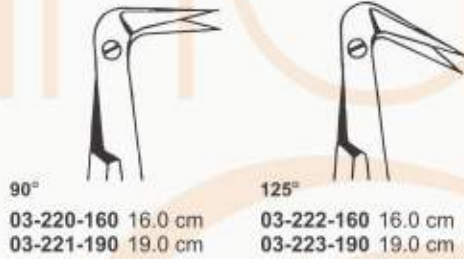
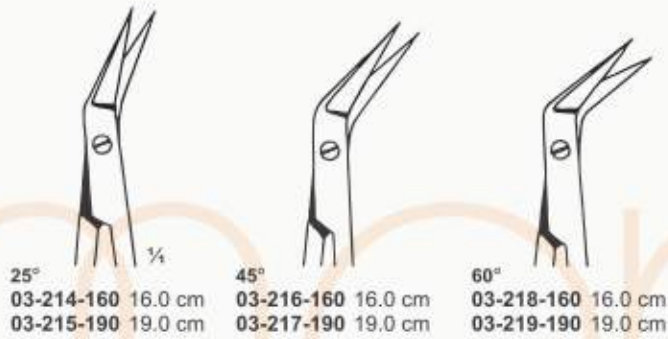

03-224-190
19.0 cm



COOLEY REVERSE
03-225-171
angled 120°
17.1 cm



POTTS-SMITH
19.0 cm

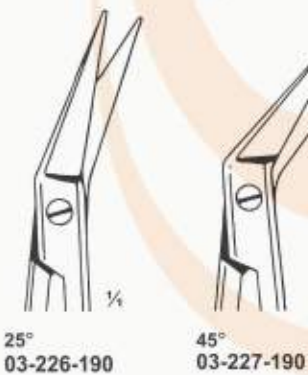

Blade Length
1.3 mm



POTTS-SMITH

Blade Length
19 mm

03-229-133
Short.
Angled 45°
13.3 cm

03-230-146
short blades
angled 45°
14.6 cm



POTTS-SMITH

OPERATING SCISSORS

Chirurgische scheren
Tijeras Para Cirugia

Ciseaux à chirurgie
Forbici per chirurgia

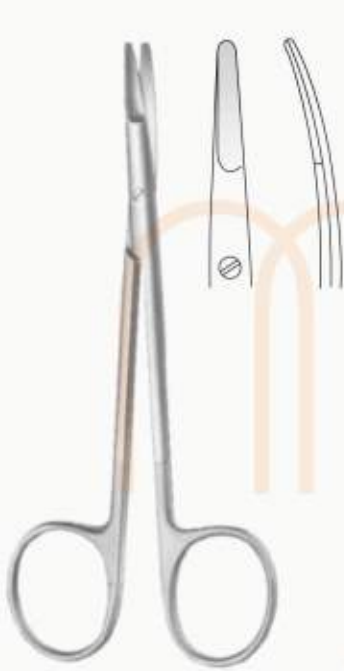

RAGNELL
03-231-125
12.5cm

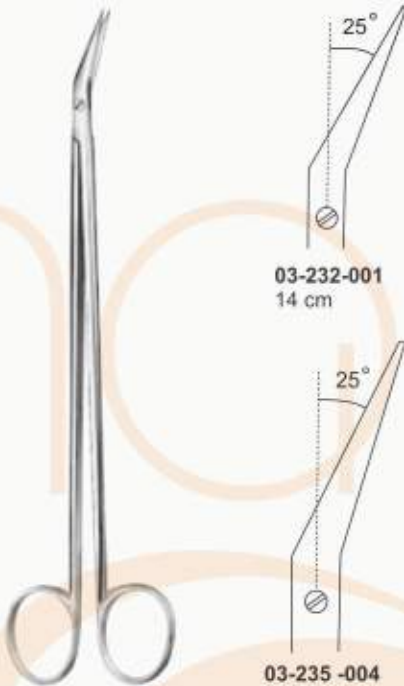

03-232-001
14 cm

03-235-004
19 cm

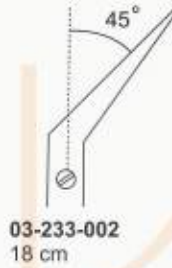

03-233-002
18 cm

03-236-005
22 cm

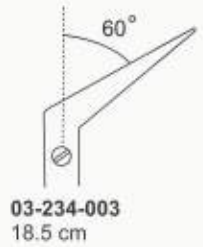

03-234-003
18.5 cm

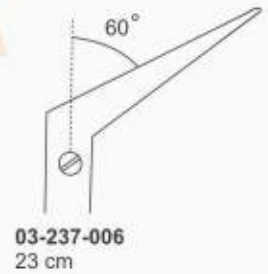

03-237-006
23 cm

- DEBAKEY**
- 03-232-140 14 cm
 - 03-233-180 18 cm
 - 03-234-185 18.5 cm
 - 03-235-190 19 cm
 - 03-236-220 22 cm
 - 03-237-230 23 cm

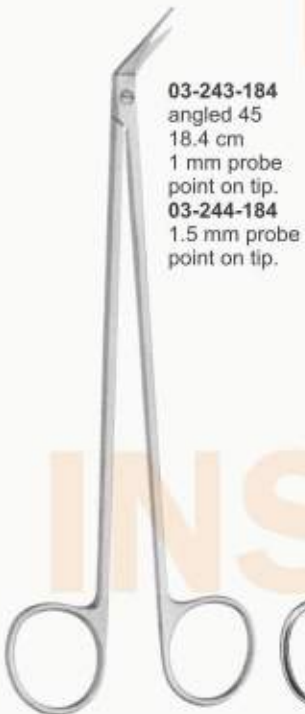

03-243-184
angled 45
18.4 cm
1 mm probe
point on tip.
03-244-184
1.5 mm probe
point on tip.



DE BAKEY

- | | | | | | |
|-----|--------------------|-----|--------------------|-----|--------------------|
| 25° | 03-245-160 16.0 cm | 45° | 03-249-160 16.0 cm | 60° | 03-253-160 16.0 cm |
| | 03-246-190 19.0 cm | | 03-250-190 19.0 cm | | 03-254-190 19.0 cm |
| | 03-247-230 23.0 cm | | 03-251-230 23.0 cm | | 03-255-230 23.0 cm |
| | 03-248-280 28.0 cm | | 03-252-280 28.0 cm | | 03-256-280 28.0 cm |



HEATH
03-257-150
15.0 cm

OPERATING SCISSORS

Chirurgische scheren
 Tijeras Para Cirugia

Ciseaux à chirurgie
 Forbici per chirurgia



STRULLY
 03-258-220
 22.0 cm



STRULLY
 03-259-220
 22.0 cm



NEUMANN
 03-260-125
 12.5 cm



MC INDOE
 03-261-190
 19.0 cm

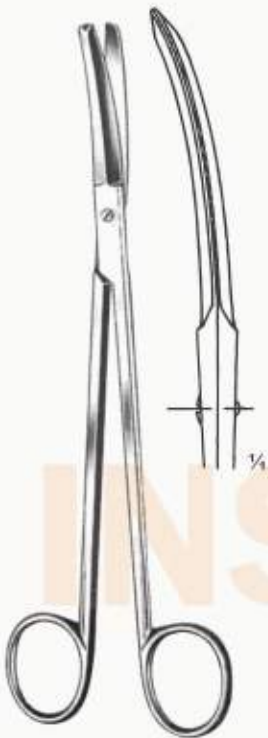

POTTS-SMITH
 03-262-190
 19.0 cm

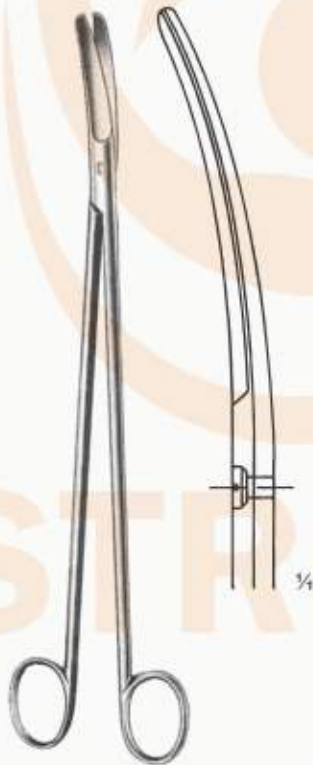

CRAFOORD
 03-263-300
 30.0 cm



OLIVECRONA
 03-264-230
 23.0 cm

OPERATING SCISSORS

Chirurgische scheren
Tijeras Para Cirugia

Ciseaux à chirurgie
Forbici per chirurgia



ANATOMY
 03-265-210
 21.0 cm



ANATOMY
 03-266-210
 21.0 cm



ANATOMY
 03-267-210
 21.0 cm



DISSECTING
 03-268-110 11.0 cm
 03-269-130 13.0 cm
 03-270-140 14.0 cm



DISSECTING
 03-271-110 11.0 cm
 03-272-130 13.0 cm
 03-273-140 14.0 cm



HEYMANN
 03-274-180
 18.0 cm



HEYMANN
 03-275-195
 19.5 cm



KNIGHT
 03-276-180
 18.0 cm



COTTLE
 03-277-160
 16cm

OPERATING SCISSORS

Chirurgische scheren
 Tijeras Para Cirugia

Ciseaux à chirurgie
 Forbici per chirurgia



FOMON
 03-278-145
 14.5cm



BEEBEE
 10.5 cm
 Straight

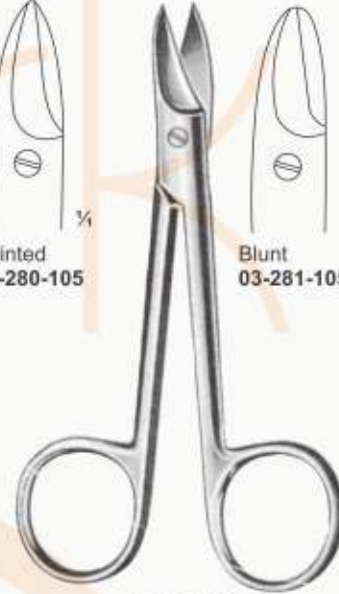
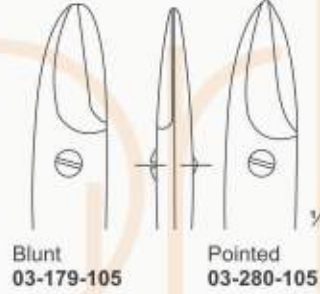

BEEBEE
 10.5 cm
 Curved



NAIL SCISSORS
 03-283-090
 9 cm
 Curved



NAIL SCISSORS
 03-284-090
 9 cm
 Curved



NAIL SCISSORS
 03-285-090
 9 cm
 Arrow Point
 Curved



NAIL NIPPER
 03-286-105
 10.5 cm

OPERATING SCISSORS

Chirurgische scheren
 Tijeras Para Cirugia

Ciseaux à chirurgie
 Forbici per chirurgia



WIRE CUTTING
 03-287-115
 11.5 cm



UNIVERSAL (Colour Available)
 03-288-145 14.5 cm
 143 C/290 F Autoclavable
 03-289-150 15 cm
 143 C/290 F Autoclavable
 03-290-160 16 cm
 143 C/290 F Autoclavable
 03-291-180 18 cm
 143 C/290 F Autoclavable



UNIVERSAL BANDAGE
 03-292-120
 12.0 cm



BRUNS
 03-294-240
 24 cm
 serrated

BRUNS
 03-293-240
 24 cm
 saw edge



ESMARCH
 03-295-200 20 cm
 03-296-220 22 cm

OPERATING SCISSORS

Chirurgische scheren
Tijeras Para Cirugia

Ciseaux à chirurgie
Forbici per chirurgia



BERGMANN
03-297-180
18.0 cm



Saw Edge

03-298-170
17.0 cm



BURNHAM BANDAGE
03-299-140
14.0 cm



SMITH (MOD. USA)
03-300-160 16.0 cm
03-301-180 18.0 cm
03-302-200 20.0 cm
03-303-230 23.0 cm



LORENZ
03-304-230
23.0 cm



KNOWLES
03-305-140
14.0 cm



for fingers

KNOWLES
03-306-145
14.5 cm



LISTER
03-307-200
20 cm



LISTER BANDAGE
03-308-115 11.5 cm
03-309-140 14.0 cm
03-310-150 15.0 cm
03-311-180 18.0 cm
03-312-195 19.5 cm
03-313-200 20.0 cm



Saw Edge

LISTER-EXCENTRIC
03-314-160 16.0 cm
03-315-190 19.0 cm

OPERATING SCISSORS

Chirurgische scheren
 Tijeras Para Cirugia

Ciseaux à chirurgie
 Forbici per chirurgia



BUSCH
 03-316-130 13.0 cm
 03-317-160 16.0 cm



BRAUN-STADLER
 03-318-140
 14.0 cm



BRAUN-STADLER
 03-319-200
 20.0 cm



$\frac{1}{4}$
03-320-100
 10 cm

MODIFIED-USA

MICRO SCISSORS

Mikroscheren micro Ciseaux
Micro Tijeras Micro Forbici



NOYES
A 03-321-120 12.0 cm
B 03-322-120 12.0 cm
C 03-323-120 12.0 cm



NOYES
03-324-120 12.0 cm
03-325-120 12.0 cm
03-326-120 12.0 cm



03-327-110



03-328-110



03-329-110



BARRAQUER
03-330-055 5 mm
03-331-055 7 mm
03-332-055 10 mm
5.5 cm



03-333-090



03-334-090



03-335-090



03-336-090

CASTROVIEJO
9.0 cm



03-337-100
Sharp

CASTROVIEJO
10.0 cm



03-338-100
Blunt

CASTROVIEJO
10.0 cm



INSTRUMENTS

MICRO SCISSORS

Mikroscheren micro Ciseaux
Micro Tijeras Micro Forbici



WESTCOTT
03-339-110
11.0 cm



WESTCOTT
03-340-110
11.0 cm



CASTROVIEJO
03-341-100
10.0 cm



CASTROVIEJO
03-342-100
10.0 cm



CASTROVIEJO
03-343-110
11.0 cm



CASTROVIEJO
03-344-110
11.0 cm



TROUTMAN
03-345-100
10.0 cm



TROUTMAN
03-346-100
10.0 cm

MICRO SCISSORS

INSTRUMENTS

Mikroscheren micro Ciseaux
 Micro Tijeras Micro Forbici



03-347-145
14.5 cm

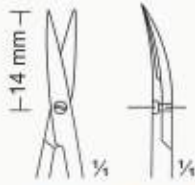

03-348-180
18.0 cm

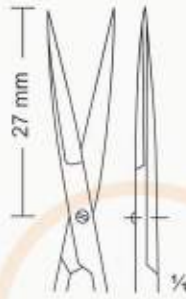

03-349-180
18.0 cm



18 cm

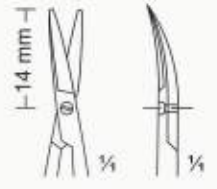

03-350-180

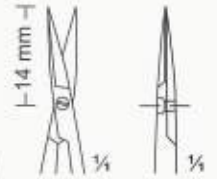

03-351-180



11.0 cm



03-352-110



15.0 cm

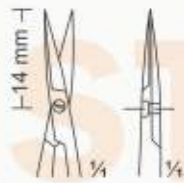

03-353-110



03-354-190

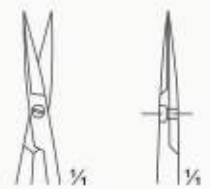

03-357-190



03-355-190

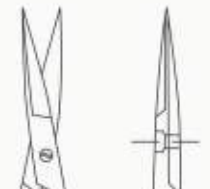

03-358-190

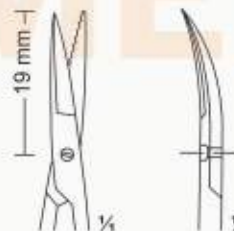

03-356-190

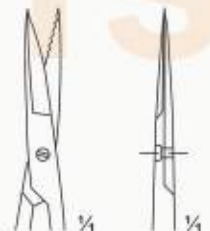

03-359-190

-Nerve-

MICRO SCISSORS

Mikroscheren micro Ciseaux
Micro Tijeras Micro Forbici



18.0 cm



03-360-180
25°



03-361-180
45°



03-362-180
60°



18.0 cm



03-365-180
25°



03-366-180
45°



03-367-180
60°



03-363-180
90°



03-364-180
125°



03-368-180
90°



03-369-180
125°



18.5 cm



03-370-185



03-371-185



16.0 cm 03-372-160
20.0 cm 03-373-200
22.5 cm 03-374-225



03-375-160
03-376-200
03-377-225



03-378-160
03-379-200
03-380-225



03-381-160
03-382-200
03-383-225



03-371-185



16.0 cm 03-384-160
20.0 cm 03-385-200
22.5 cm 03-386-225



03-387-160
03-388-200
03-389-225



INSTRUMENTS

SUPER CUT SCISSORS

Super Cut Schere *Ciseaux SuperCut*
Súper Cut Tijeras *Forbici SuperCut*



BABY METZENBAUM
03-390-114
11.4 cm
straight



BABY METZENBAUM
03-391-114
11.4 cm
Curved



IRIS
03-392-090 9.0 cm
03-393-114 11.4 cm
Straight



IRIS
03-394-090 9 cm
03-395-090 9 cm
Curved



GOLDMAN-FOX
03-396-090 Straight 9 cm
03-397-090 Curved 9 cm



STEVENS TENOTOMY
03-398-090 Straight 9 cm
03-399-090 Curved 9 cm



STEVENS TENOTOMY
03-400-114 Straight 11.4 cm
03-401-114 Curved 11.4 cm

SUPER CUT SCISSORS

Super Cut Schere Ciseaux SuperCut
 Súper Cut Tijeras Forbici SuperCut



MAYO
 03-402-140 14 cm
 03-403-150 15 cm
 03-404-180 18 cm
 03-405-200 20 cm
 03-406-230 23 cm



MAYO
 03-407-140 14 cm
 03-408-170 17 cm
 Straight



MAYO
 03-409-140 14 cm
 03-410-170 17 cm
 Curved



STANDARD S/B
 03-411-140
 14 cm
 Straight



STANDARD S/B
 03-412-140
 14 cm
 Curved



METZENBAUM
 03-413-140 14 cm
 03-414-160 16 cm
 03-415-180 18 cm
 03-416-200 20 cm
 03-417-230 23 cm
 03-418-280 28 cm
 03-419-300 30 cm



POTTS-SMITH
 03-420-178 Angled 25°
 03-421-178 Angled 45°
 03-422-178 Angled 60°
 17.8 cm

OPERATING SCISSORS T.C.

Chirurgische scheren
 Tijeras quirúrgicas

Ciseaux chirurgicaux
 Forbici per chirurgia



STANDARD



03-423-145
 14.5 cm Straight
 03-424-145
 14.5 cm Curved



03-425-165
 16.5 cm Straight
 03-426-165
 16.5 cm Curved



03-427-185
 18.5 cm Straight
 03-428-185
 18.5 cm Curved



STANDARD



03-429-145
 14.5 cm Straight
 03-430-145
 14.5 cm Curved



03-431-165
 16.5 cm Straight
 03-432-165
 16.5 cm Curved



03-433-185
 18.5 cm Straight
 03-434-185
 18.5 cm Curved

OPERATING SCISSORS T.C.

Chirurgische scheren
 Tijeras quirúrgicas

Ciseaux chirurgicaux
 Forbici per chirurgia



STANDARD



03-435-145
 14.5 cm Straight
 03-436-145
 14.5 cm Curved



03-437-165
 16.5 cm Straight
 03-438-165
 16.5 cm Curved

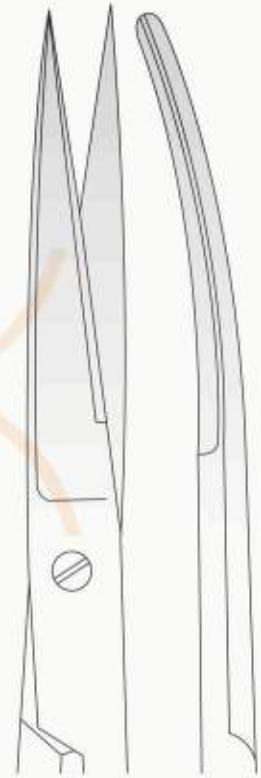

03-439-185
 18.5 cm Straight
 03-440-185
 18.5 cm Curved



MAYO
 03-441-140 14 cm
 03-442-170 17 cm
 03-443-230 23 cm
 blunt/blunt



MAYO
 03-444-140 14 cm
 03-445-170 17 cm
 03-446-230 23 cm
 blunt/blunt, Cvd.



KELLY
 03-447-160 16 cm
 03-448-170 18 cm
 blunt/blunt,
 Curved

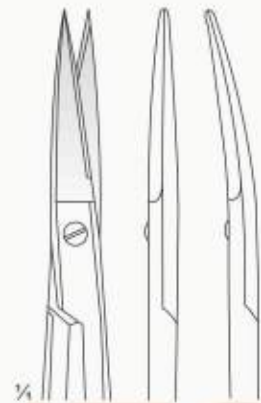

OPERATING SCISSORS T.C.

Chirurgische scheren
 Tijeras quirúrgicas

Ciseaux chirurgicaux
 Forbici per chirurgia



MAYO-STILLE
 03-449-150 15 cm
 03-450-170 17 cm
 blunt/blunt, Cvd.



LEXER
 03-451-160 16 cm
 03-452-215 21.5 cm
 blunt/blunt, Str.



LEXER
 03-453-160 16 cm
 03-454-215 21.5 cm
 blunt/blunt, Cvd.

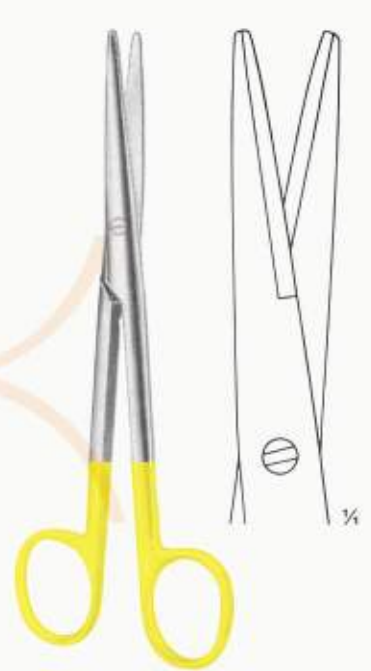

MAYO-STILLE
 03-455-150 15 cm
 03-456-170 17 cm
 blunt/blunt, Str.



SIMS
 03-457-230
 23.0 cm
 Straight



SIMS
 03-458-230
 23.0 cm
 Curved



GOLDMAN-FOX
 03-459-130
 13.0 cm



GOLDMAN-FOX
 03-460-130
 13.0 cm

OPERATING SCISSORS T.C.

Chirurgische scheren
Tijeras quirúrgicas

Ciseaux chirurgicaux
Forbici per chirurgia



METZENBAUM
Blunt / Blunt
Straight



METZENBAUM
Blunt / Blunt
Curved

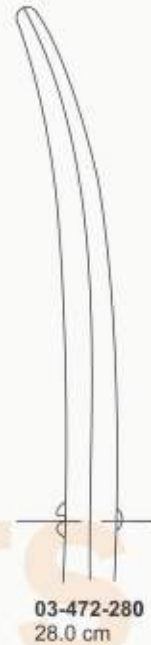

OPERATING SCISSORS T.C.

Chirurgische scheren
Tijeras quirúrgicas

Ciseaux chirurgicaux
Forbici per chirurgia



METZENBAUM
Sharp / Sharp
Straight

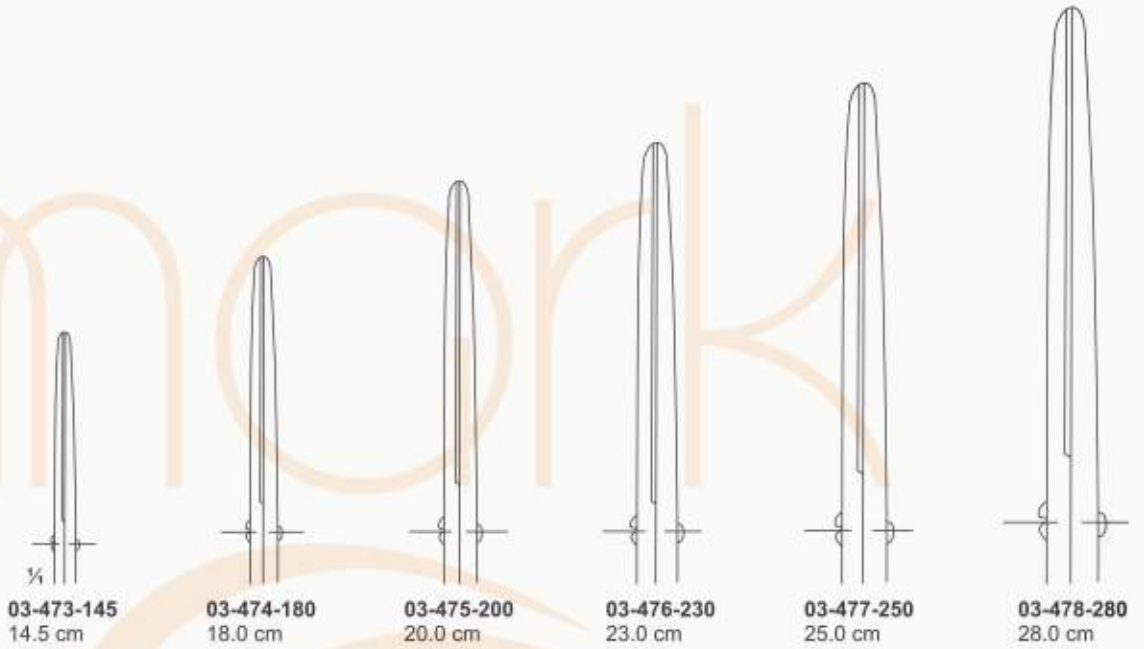

METZENBAUM
Sharp / Sharp
Curved

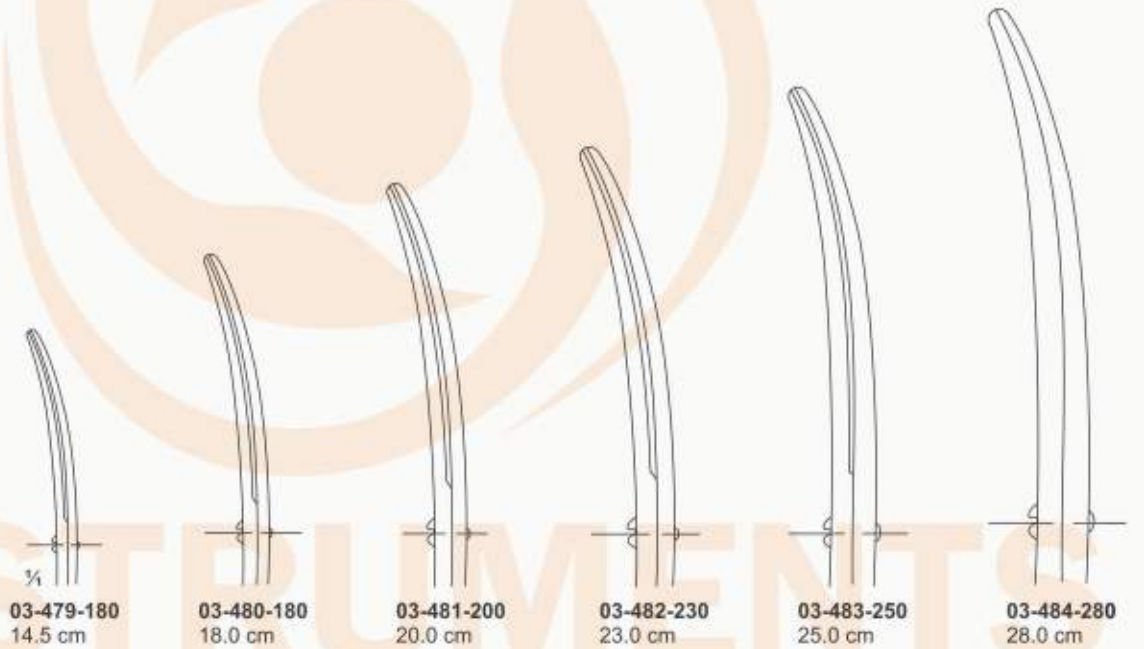

OPERATING SCISSORS T.C.

Chirurgische scheren
 Tijeras quirúrgicas

Ciseaux chirurgicaux
 Forbici per chirurgia



RAGNELL
 03-485-125
 12.5cm



DEAN
 03-486-175
 17.5 cm



JOSEPH
 03-487-145
 14.5 cm



LOCKLIN
 03-488-160
 16 cm



LOCKLIN
 03-489-160
 16 cm

OPERATING SCISSORS T.C.

Chirurgische scheren
Tijeras quirúrgicas

Ciseaux chirurgicaux
Forbici per chirurgia



POTTS-SMITH
19.0 cm



IRIS
03-493-110
11cm 4 1/2"



DEBAKEY

- 03-494-140 14.0 cm
- 03-495-180 18.0 cm
- 03-496-185 18.5 cm
- 03-497-190 19.0 cm
- 03-498-220 22.0 cm
- 03-499-230 23.0 cm

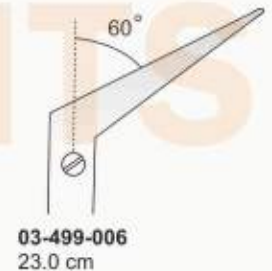
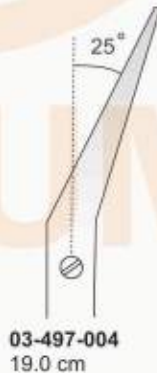
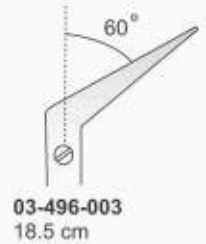
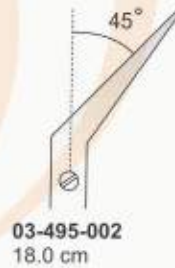
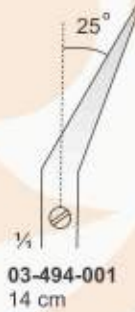

OPERATING SCISSORS T.C.

Chirurgische scheren
 Tijeras quirúrgicas

Ciseaux chirurgicaux
 Forbici per chirurgia



IRIS
 03-505-115
 11.5 cm Straight
 03-506-115
 11.5 cm Curved



STRABISMUS
 03-507-115
 11.5 cm Curved



FOMON
 03-508-145
 14.5cm



LISTER BANDAGE
 03-509-190
 19.0 cm

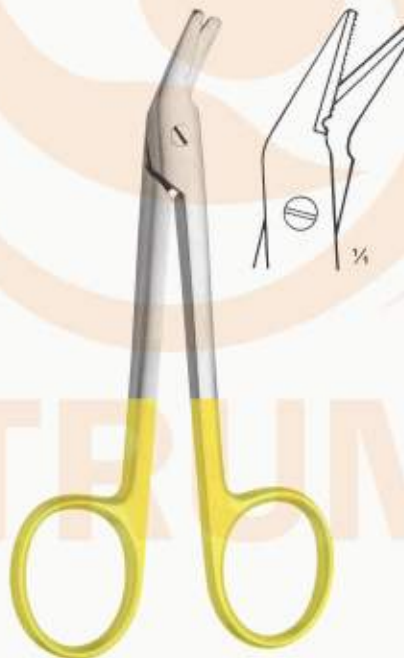

WIRE CUTTING
 03-510-115
 11.5 cm



BRUNS
 03-511-210
 21 cm

SECTION - 04

HAEMOSTATIC FORCEPS

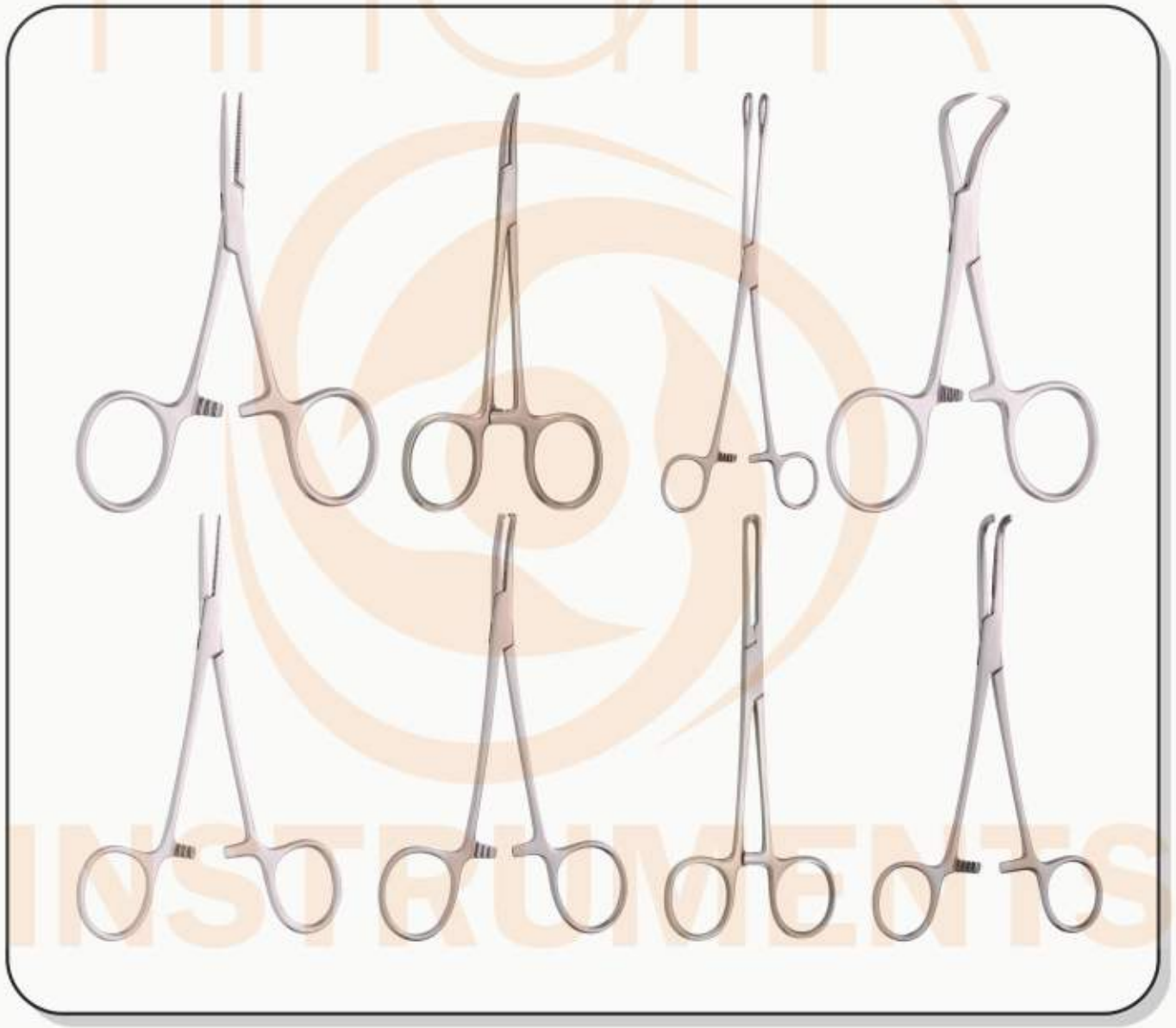

HAEMOSTATIC FORCEPS

Arterienklemmen Pinzas Hemostaticas
Pinces Hemostatiques Pinze Emostatiche

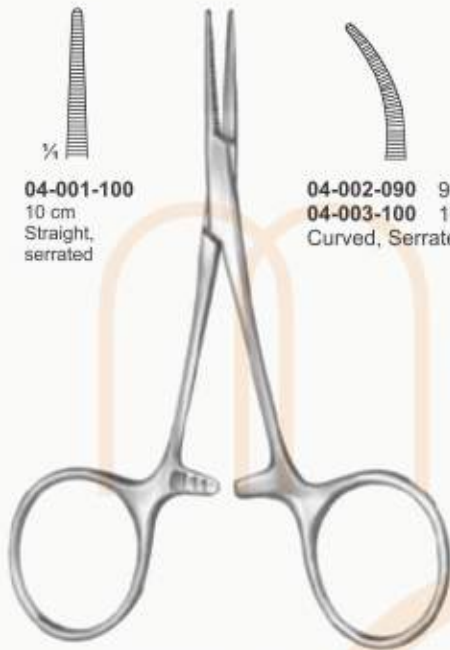

04-001-100
10 cm
Straight,
serrated

HARTMANN / MOSQUITO



04-002-090 9.0 cm
04-003-100 10 cm
Curved, Serrated



04-004-100 10 cm
04-005-120 12 cm

KOCHER MOSQUITO 1:2



04-006-100 10 cm
04-007-120 12 cm



HALSTED-MOSQUITO



04-008-125 12.5 cm
04-009-140 14.0 cm
straight, serrated



04-010-180 18 cm
straight,
serrated



04-011-210 21 cm
straight,
serrated



04-012-125 12.5 cm
04-013-140 14.0 cm
Curved,
serrated



04-114-180 18 cm
Curved,
serrated

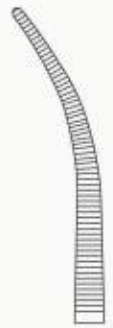

04-115-205 20.5 cm
Curved,
serrated



04-016-125 12.5 cm
04-017-140 14.0 cm
Straight, 1:2 Teeth



04-018-180 18 cm
Straight,
1:2 Teeth



04-019-210 21 cm
Straight,
1:2 Teeth



04-020-125 12.5 cm
04-021-140 14.0 cm
Curved, 1:2 Teeth



04-022-180 18 cm
Curved,
1:2 Teeth



04-023-205 20.5 cm
Curved,
1:2 Teeth

HAEMOSTATIC FORCEPS

Arterienklemmen Pinzas Hemostaticas
Pinces Hemostatiques Pinze Emostatiche

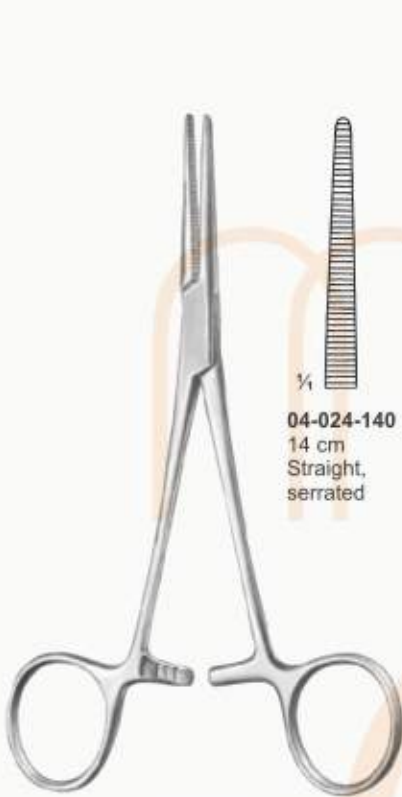

CRILE



04-024-140
14 cm
Straight,
serrated



04-025-140
14 cm
Curved,
serrated



04-026-140
14 cm
Straight,
1:2 Teeth



04-027-140
14 cm
Curved,
1:2 Teeth

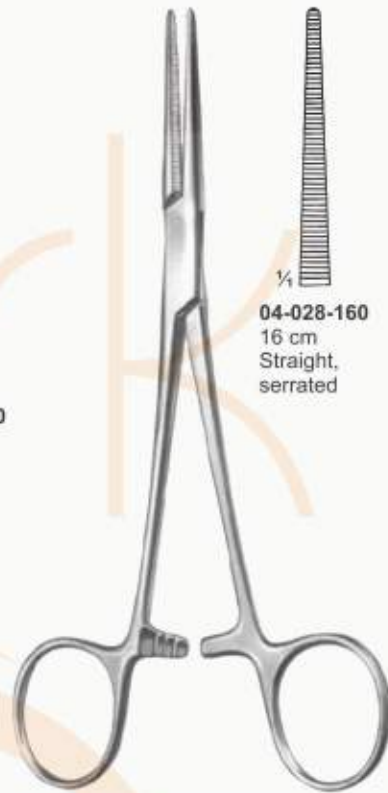

CRILE-RANKIN



04-028-160
16 cm
Straight,
serrated



04-029-160
16 cm
Curved,
serrated

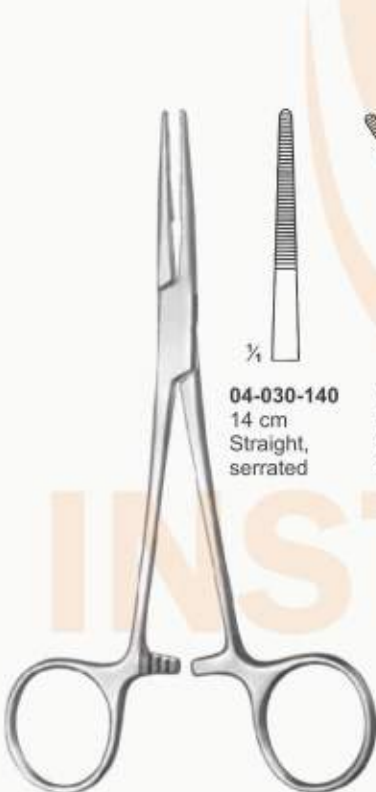

KELLY



04-030-140
14 cm
Straight,
serrated



04-031-140
14 cm
Curved,
serrated

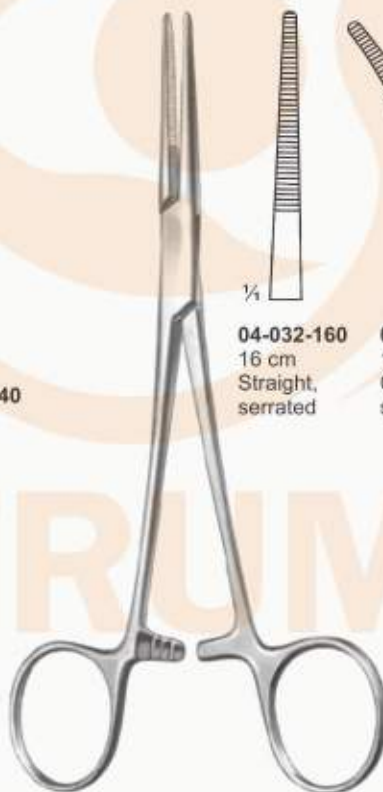

KELLY-RANKIN



04-032-160
16 cm
Straight,
serrated



04-033-160
16 cm
Curved,
serrated



PROVIDENCE / HOSPITAL



04-034-140
14 cm
Straight,
serrated



04-035-140
14 cm
Curved,
serrated

HAEMOSTATIC FORCEPS

Arterienklemmen Pinzas Hemostaticas
Pinces Hemostatiques Pinze Emostatiche



SPENCER-WELLS



04-036-130
13 cm



04-037-140
14 cm



04-038-155
15.5 cm



04-039-180
18 cm



04-040-200
20 cm



04-041-130
13 cm



04-042-140
14 cm



04-043-155
15.5 cm



04-044-180
18 cm



04-045-200
20 cm



DUNHILL
04-046-130 13.0 cm
Straight, box joint,
as above but curved on flat.



CAIRNS
04-047-145 14.5 cm
Straight, box joint,
as above but curved on flat.

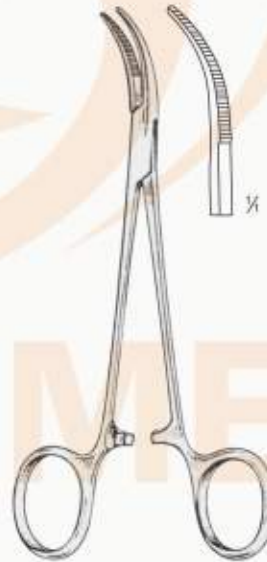

CAIRNS
04-048-145 14.5 cm
curved laterally, joint



GREY TURNER

04-149-145
14.5 cm
04-150-180
18 cm
Straight
Joint.

HAEMOSTATIC FORCEPS

Arterienklemmen Pinzas Hemostaticas
 Pincas Hemostatiques Pinze Emostatiche



CRAFOORD-SELLORS



04-051-220
22.0 cm



04-052-230
23.0 cm



04-053-240
24.0 cm



ROBERTS



04-054-220
22.0 cm



04-055-220
22.0 cm



HEISS
20.0 cm



Fig.1
04-056-200



Fig.2
04-057-200



Fig.3
04-058-200



CRAFOORD



04-059-240
24.0 cm

HAEMOSTATIC FORCEPS

Arterienklemmen

Pinzas Hemostaticas

Pinces Hemostatiques

Pinze Emostatiche



ROCHESTER / PEAN



04-060-140
14 cm
straight,
serrated



04-061-160
16 cm
straight,
serrated



04-062-180
18 cm
straight,
serrated



04-063-200
20 cm
straight,
serrated

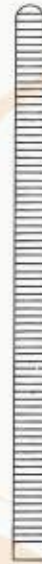

04-064-220
22 cm
straight,
serrated



04-065-240
24 cm
straight,
serrated



04-066-260
26 cm
straight,
serrated



04-067-300
30 cm
straight,
serrated



04-068-140
14 cm
Curved,
serrated



04-069-160
16 cm
Curved,
serrated



04-070-180
18 cm
Curved,
serrated



04-071-200
20 cm
Curved,
serrated



04-072-220
22 cm
Curved,
serrated



04-073-240
24 cm
Curved,
serrated



04-074-260
26 cm
Curved,
serrated

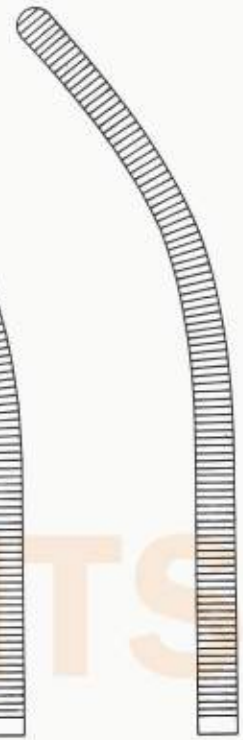

04-075-300
30 cm
Curved,
serrated

HAEMOSTATIC FORCEPS

Arterienklemmen Pinzas Hemostaticas
Pincas Hemostatiques Pinze Emostatiche



KOCHER / DELICATE



04-076-130 13 cm
04-077-140 14 cm
04-078-160 16 cm
Straight, 1:2 Teeth



04-079-140 14 cm
curved,
1:2 Teeth

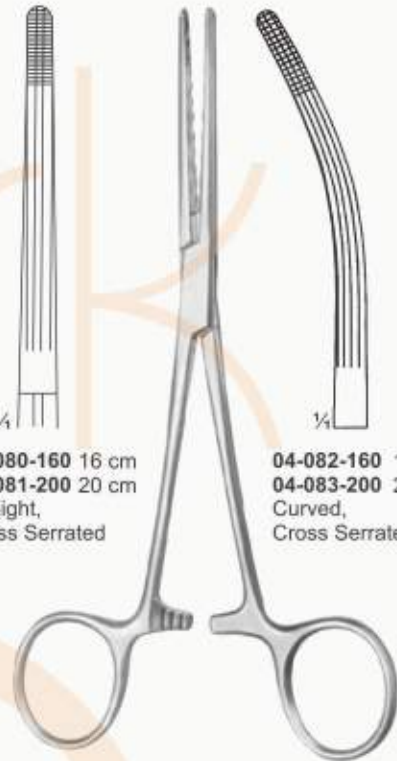

ROCHESTER / CARMALT



04-080-160 16 cm
04-081-200 20 cm
Straight,
Cross Serrated



04-082-160 16 cm
04-083-200 20 cm
Curved,
Cross Serrated



PEAN - DELICATE

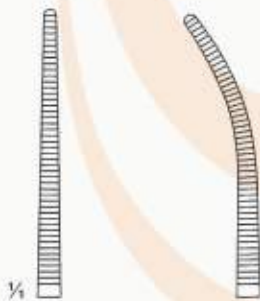

04-084-140 14 cm
04-085-160 16 cm
04-086-180 18 cm
Straight, Serrated

04-087-140 14 cm
04-088-160 16 cm
04-089-180 18 cm
Curved, Serrated



PEAN



04-090-140 14 cm
04-091-160 16 cm

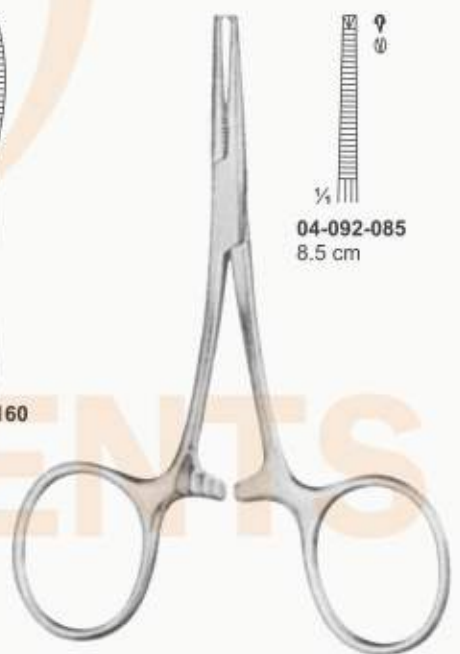

TERRIER 1:2



04-092-085
8.5 cm

HAEMOSTATIC FORCEPS

Arterienklemmen
Pinces Hemostatiques

Pinzas Hemostaticas
Pinze Emostatiche



LERICHE

¼
04-093-150
15 cm

¼
04-094-150
15 cm

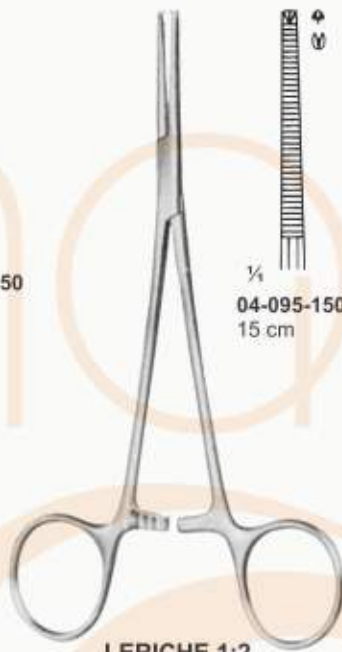

LERICHE 1:2

¼
04-095-150
15 cm

¼
04-096-150
15 cm



DANDY

¼
04-097-140
14 cm



DANDY 1:2

¼
04-098-140
14 cm

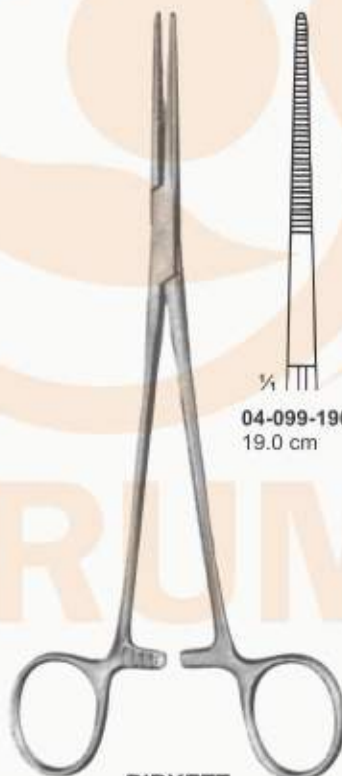

BIRKETT

¼
04-099-190
19.0 cm

¼
04-100-190
19.0 cm

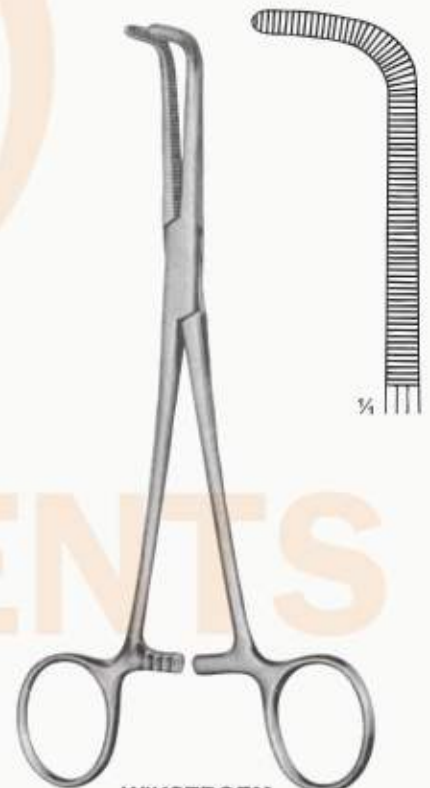

WIKSTROEM
04-101-190
19.0 cm

¼

HAEMOSTATIC FORCEPS

Arterienklemmen
Pincas Hemostaticas

Pinzas Hemostaticas
Pinze Emostatiche



04-102-140
14 cm
curved,
serrated



04-103-180
18 cm
curved,
serrated



04-104-180
18 cm



04-105-180
18 cm

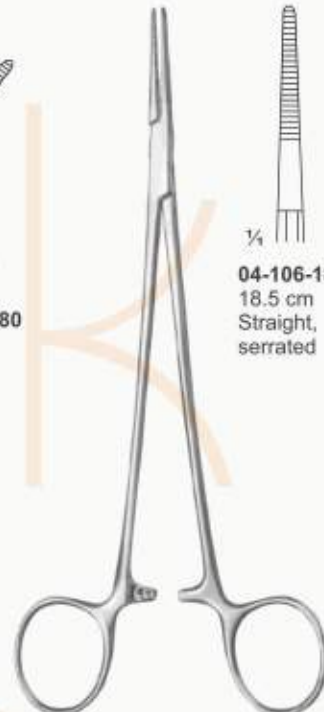

04-106-185
18.5 cm
Straight,
serrated



04-107-185
18.5 cm
curved,
serrated

BABY-ADSON

ADSON

Straight, box joint,
as above but curved flat.
Straight, box joint,
one into two teeth

ADSON



04-108-185
18.5 cm



04-109-185
18.5 cm

ADSON 1:2



04-110-240
24 cm
Curved,
Serrated

SAROT

HAEMOSTATIC FORCEPS

Arterienklemmen Pinzas Hemostaticas
Pinces Hemostatiques Pinze Emostatiche

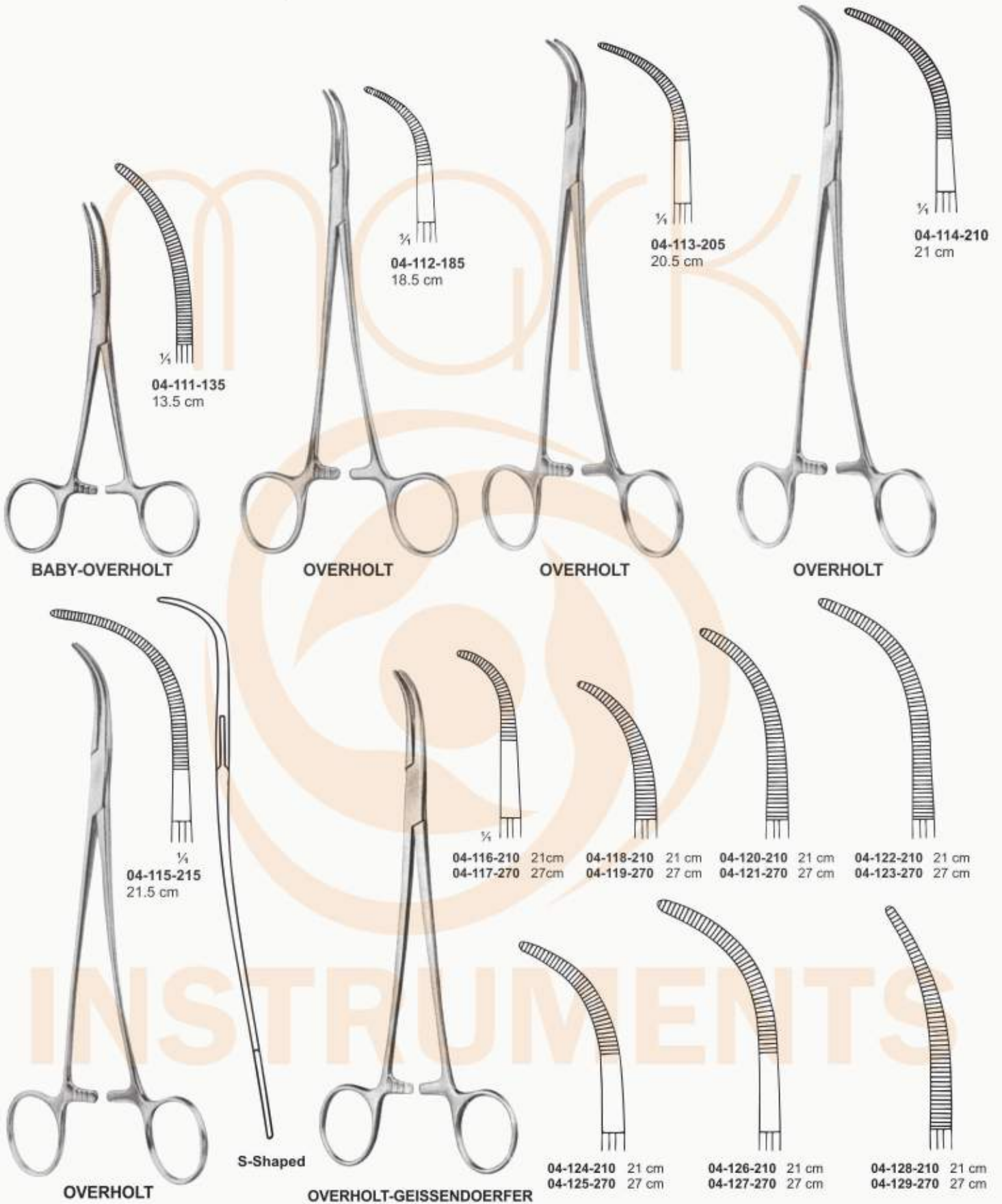

HAEMOSTATIC FORCEPS

Arterienklemmen Pinzas Hemostaticas
 Pincas Hemostatiques Pinze Emostatiche



¼
04-130-150
 15 cm
04-131-185
 18.5 cm

BAINBRIDGE



04-132-150
 15 cm
04-133-185
 18.5 cm



¼
04-134-280
 28 cm
 Curved,
 Serrated

BRIDGE



¼
04-135-280
 28.0 cm

LAWERNCE



¼
04-136-180
 18 cm
 Curved,
 Serrated

MINI-GEMINI



¼
04-137-130 13 cm
04-138-180 18 cm
04-139-200 20 cm
 Curved, Serrated

GEMINI

INSTRUMENTS

HAEMOSTATIC FORCEPS

INSTRUMENTS

Arterienklemmen
 Pincas Hemostaticas
 Pinces Hemostatiques

Pinzas Hemostaticas
 Pinze Emostatiche



RUMEL
 23.0 cm



BENGOLEA



BENGOLEA 1:2



HAEMOSTATIC FORCEPS

Arterienklemmen Pinzas Hemostaticas
 Pincas Hemostatiques Pinze Emostatiche

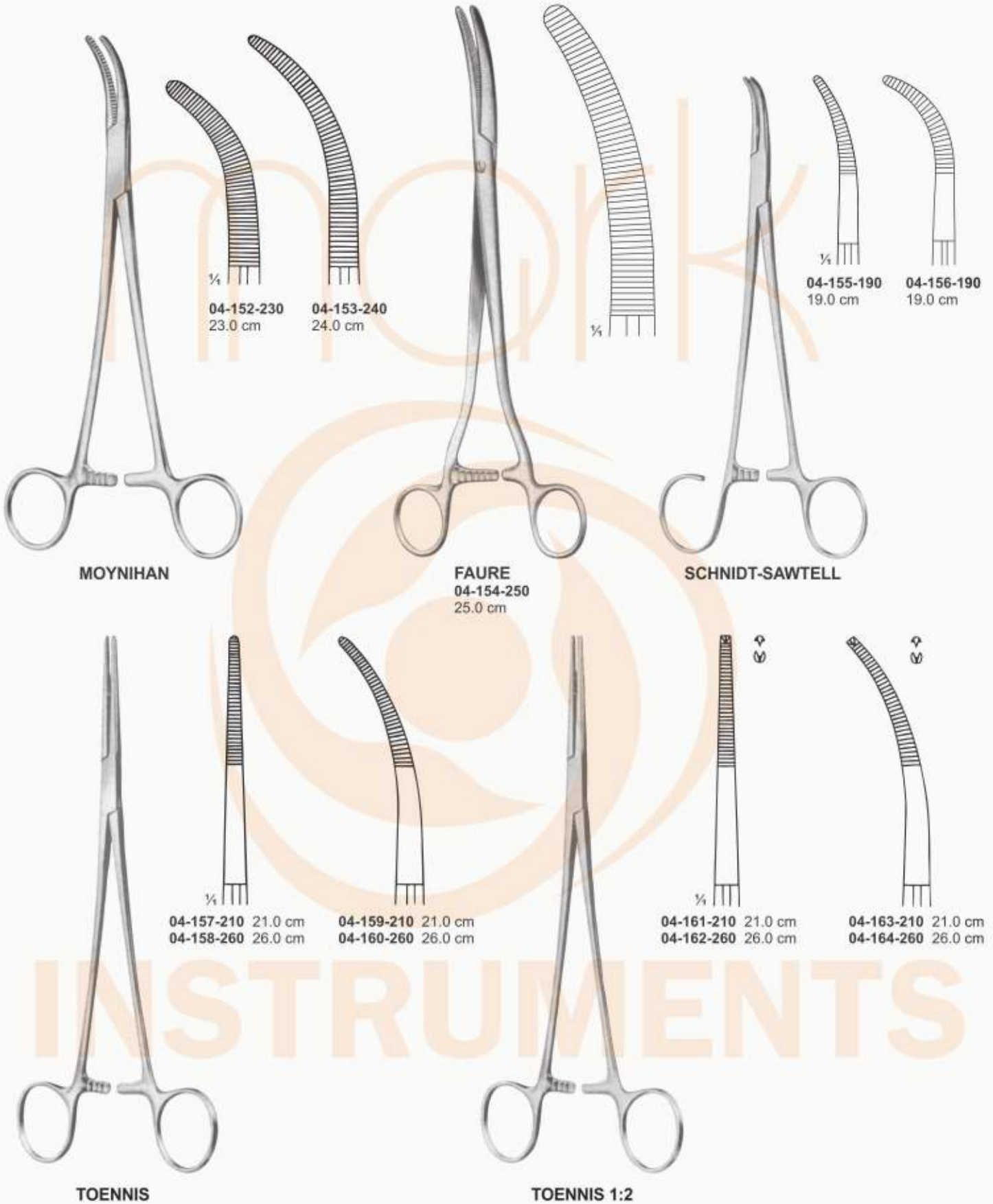

HAEMOSTATIC FORCEPS

Arterienklemmen

Pinzas Hemostaticas

Pinces Hemostatiques

Pinze Emostatiche



04-165-140
 14 cm
 Curved,
 Serrated

BABY-MIXTER



04-166-180
 18.0 cm

BABY-MIXTER



04-167-220
 22.0 cm

MIXTER



04-168-210
 21 cm
 Right Angle
 Grooves

MIXTER



04-169-155
 15.5 cm
 Fully Curved,
 Serrated

MIXTER



04-170-190
 19 cm
 Fully Curved,
 Serrated

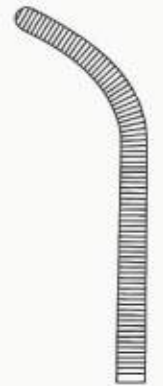

04-171-230
 23 cm
 Fully Curved,
 Serrated

HAEMOSTATIC FORCEPS

Arterienklemmen

Pinzas Hemostaticas

Pinces Hemostatiques

Pinze Emostatiche

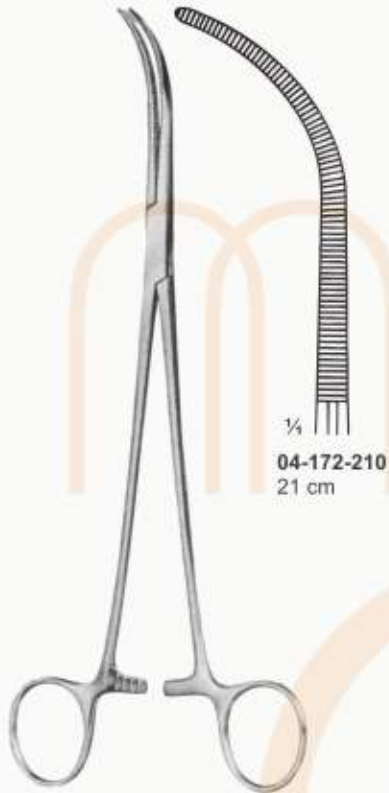

04-172-210
21 cm

OVERHOLT-MIXTER



04-173-155
15.5 cm

MIXTER-O'SHAUGNESSY



04-174-190
19.0 cm



04-175-190
19 cm
Curved,
Grooves

LAHEY



LAHEY
04-176-230
23.0 cm



04-177-180
18 cm
S Curve,
Coarse
serration

DEAN-SHALLCROSS

HAEMOSTATIC FORCEPS

INSTRUMENTS

Arterienklemmen
 Pinces Hemostatiques

Pinzas Hemostaticas
 Pinze Emostatiche



04-178-210
 21 cm
 light jaws

HEANEY

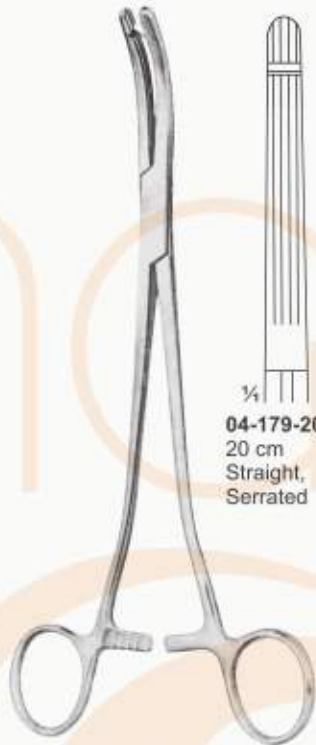

04-179-200
 20 cm
 Straight,
 Serrated

HEANEY / BALLANTINE



04-180-200
 20 cm
 Slight Curve,
 Serrated

HEANEY / REZAK



04-181-210
 21 cm
 Straight, Cross
 Serrated



HEANEY

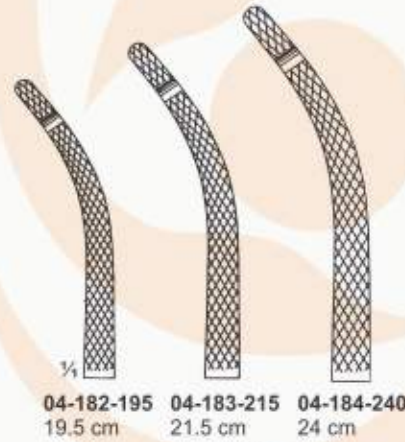

04-182-195 19.5 cm
 04-183-215 21.5 cm
 04-184-240 24 cm

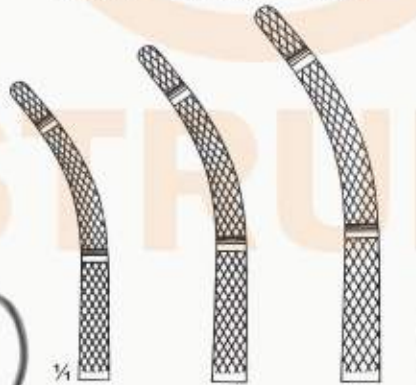

04-185-195 19.5 cm
 04-186-215 21.5 cm
 04-187-240 24 cm



HEANEY-KANTER

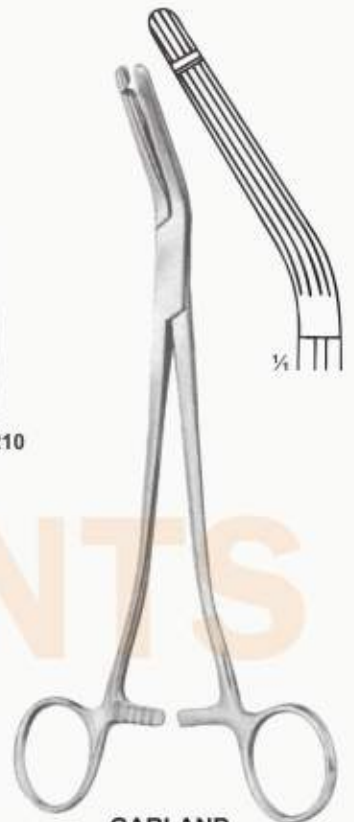

GARLAND
 04-189-210
 21.0 cm

HAEMOSTATIC FORCEPS

Arterienklemmen

Pinzas Hemostaticas

Pinces Hemostatiques

Pinze Emostatiche

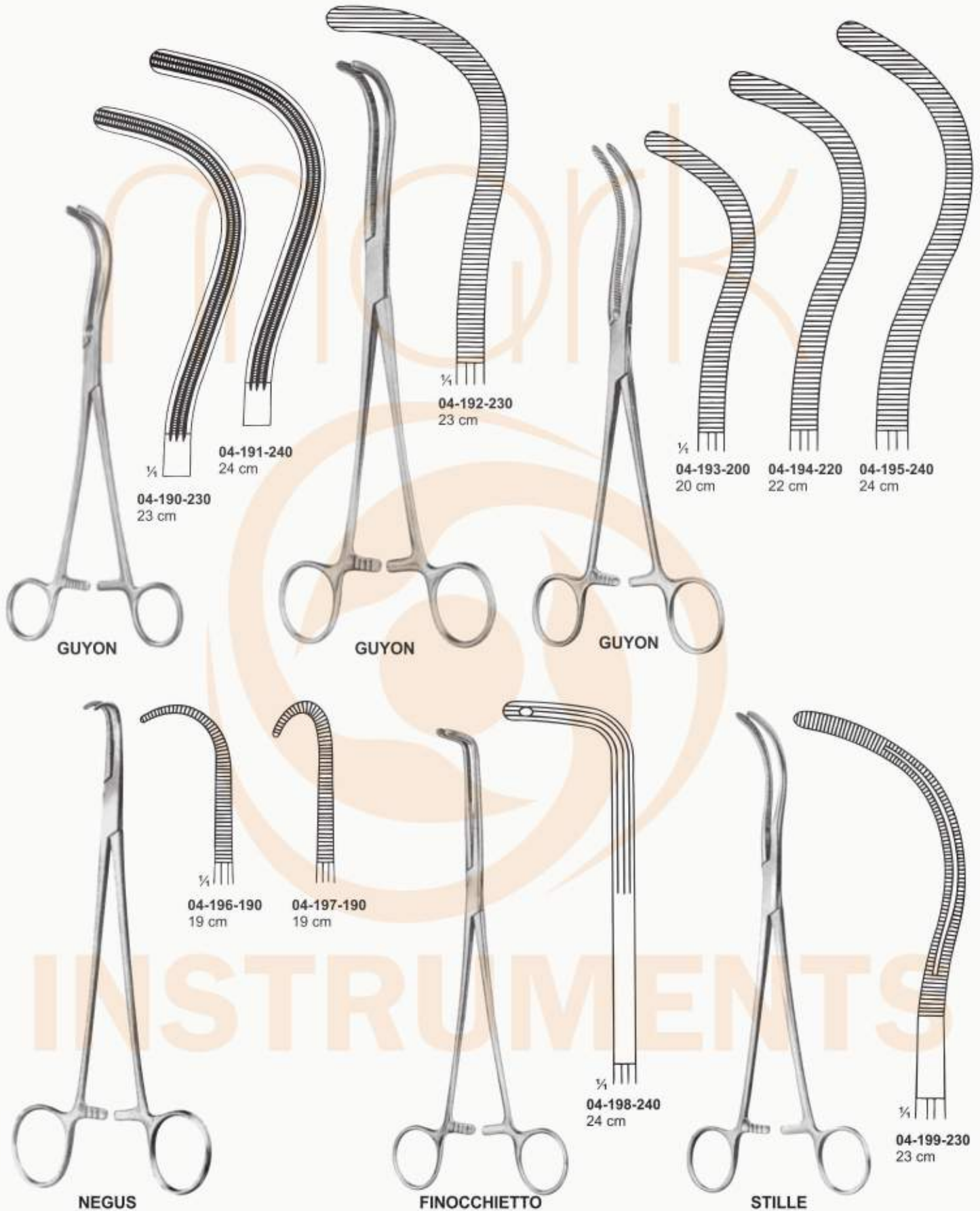

HAEMOSTATIC FORCEPS

Arterienklemmen Pinzas Hemostaticas
 Pincas Hemostatiques Pinze Emostatiche



INSTRUMENTS

HAEMOSTATIC FORCEPS

Arterienklemmen Pinzas Hemostaticas
 Pincas Hemostatiques Pinze Emostatiche



ROCHESTER / OCHSNER / KOCHER

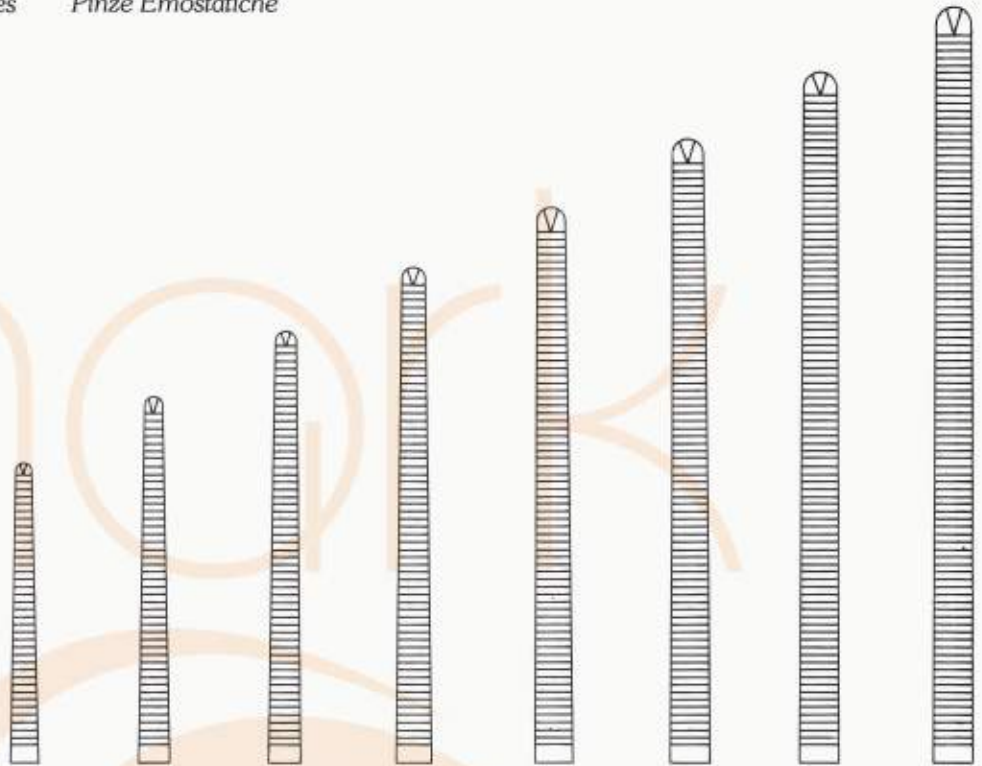

- | | | | | | | | |
|--|--|--|--|--|--|--|--|
| 04-204-140
14 cm
straight,
1:2 Teeth | 04-205-160
16 cm
straight,
1:2 Teeth | 04-206-180
18 cm
straight,
1:2 Teeth | 04-207-200
20 cm
straight,
1:2 Teeth | 04-208-220
22 cm
straight,
1:2 Teeth | 04-209-240
24 cm
straight,
1:2 Teeth | 04-210-260
26 cm
straight,
1:2 Teeth
serrated | 04-211-300
30 cm
straight,
1:2 Teeth
serrated |
|--|--|--|--|--|--|--|--|

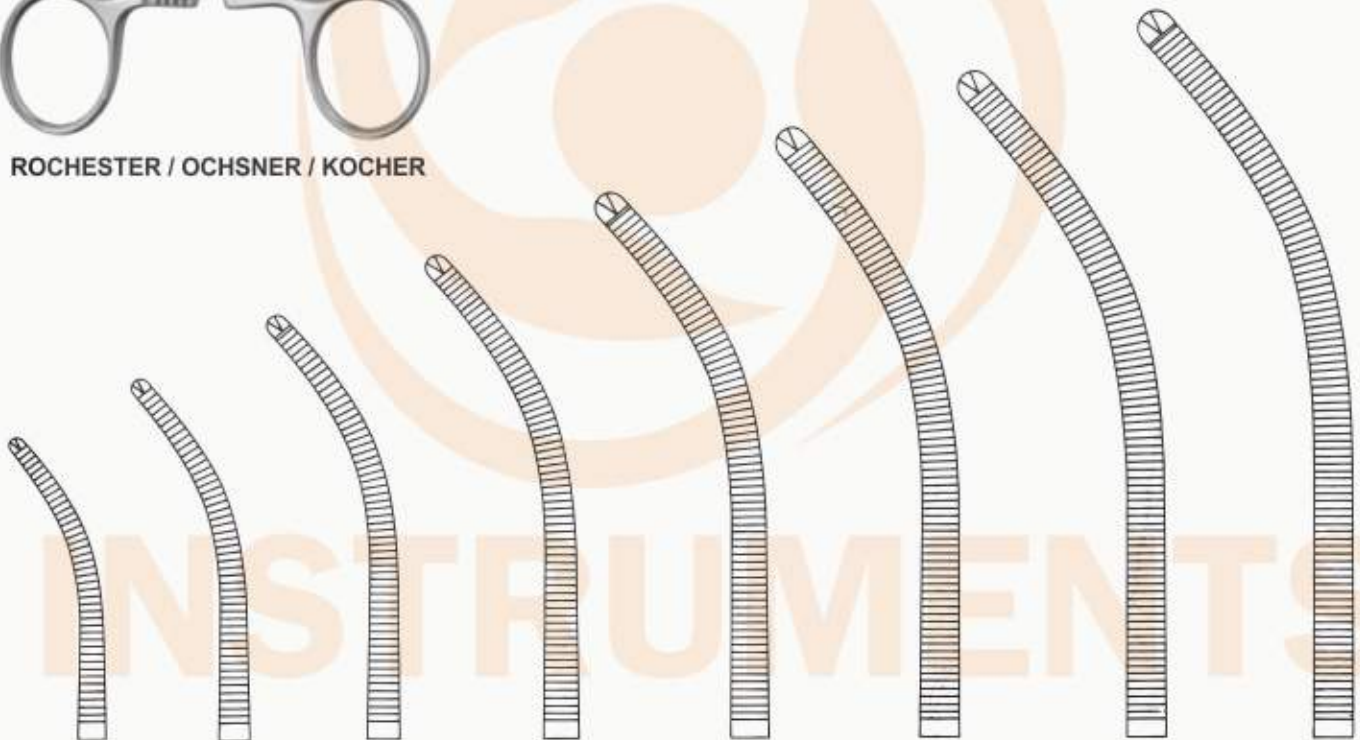

- | | | | | | | | |
|--|--|--|--|--|--|--|--|
| 04-212-140
14 cm
Curved,
1:2 Teeth | 04-213-160
16 cm
Curved,
1:2 Teeth | 04-214-180
18 cm
Curved,
1:2 Teeth | 04-215-200
20 cm
Curved,
1:2 Teeth | 04-216-220
22 cm
Curved,
1:2 Teeth | 04-217-240
24 cm
Curved,
1:2 Teeth | 04-218-260
26 cm
Curved,
1:2 Teeth | 04-219-300
30 cm
Curved,
1:2 Teeth |
|--|--|--|--|--|--|--|--|

HAEMOSTATIC FORCEPS

Arterienklemmen
Pincas Hemostaticas
Pinces Hemostatiques

Pinzas Hemostaticas
Pinze Emostatiche



HAEMOSTATIC FORCEPS

INSTRUMENTS

Arterienklemmen
 Pinces Hemostatiques

Pinzas Hemostaticas
 Pinze Emostatiche

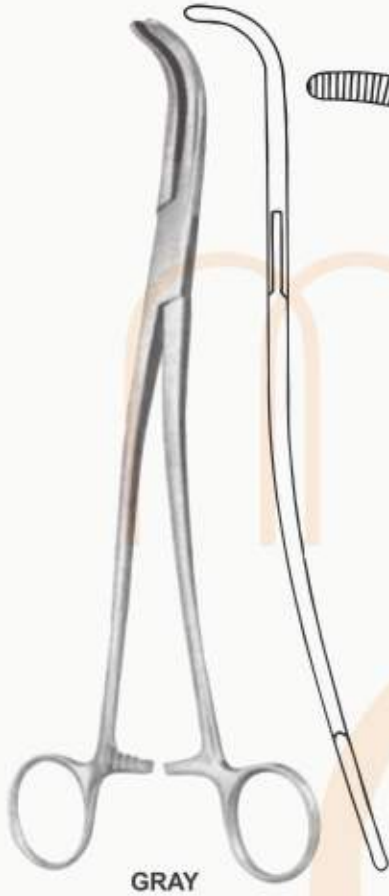

GRAY

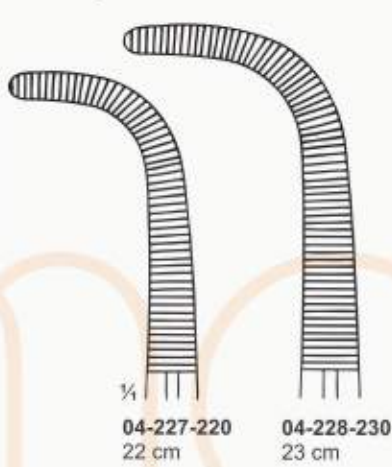

04-227-220
22 cm

04-228-230
23 cm



GRAY 1:2

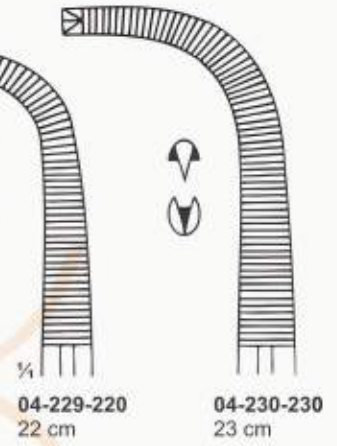

04-229-220
22 cm

04-230-230
23 cm



PHANEUF 1:2

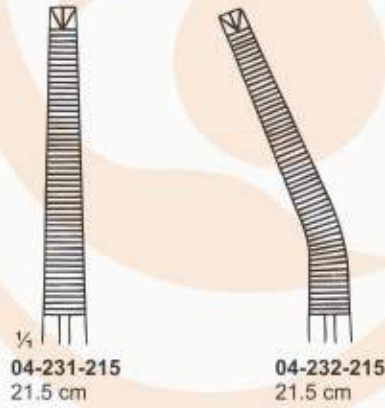

04-231-215
21.5 cm

04-232-215
21.5 cm

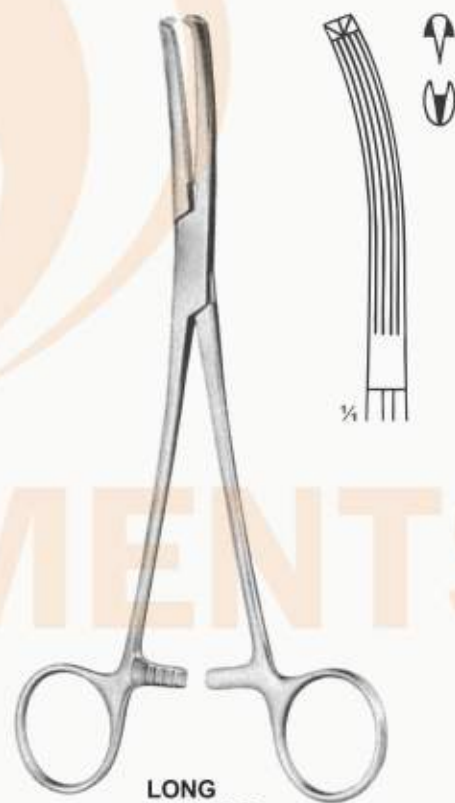

LONG
04-233-190
19.0 cm

INSTRUMENTS

TOWEL FORCEPS

INSTRUMENTS

Tuchklemmen Pincès à champs
 Pinzas de campo Pinze fissatele



JONES / PERFORATING
 04-234-090
 9 cm
 Slight Curve



ENGL. MODELL
 04-235-090
 9 cm



SCHAEDEL
 04-236-090
 9 cm



DOYEN
 04-237-180
 18 cm

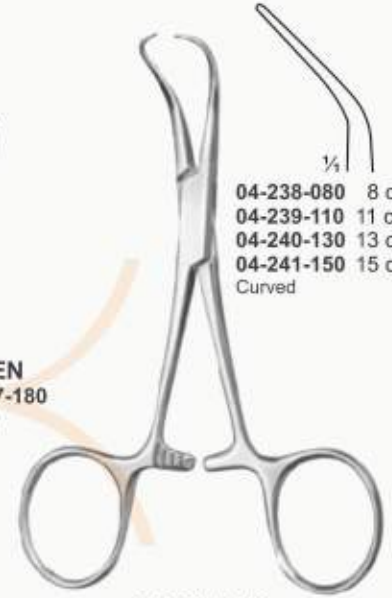

04-238-080 8 cm
 04-239-110 11 cm
 04-240-130 13 cm
 04-241-150 15 cm
 Curved

BACKHAUS



ROEDER

04-242-130
 13 cm
 Curved,
 Serrated



NON-PERFORATING

04-243-110 11 cm
 04-244-130 13 cm



LORNA

04-245-100 10 cm
 04-246-110 11 cm
 04-247-130 13 cm



BACKHAUS CLIP

04-248-110
 11 cm
 with clip for
 tubing or
 cable



BALL & SOCKET

04-249-130
 13 cm
 Non-perforating

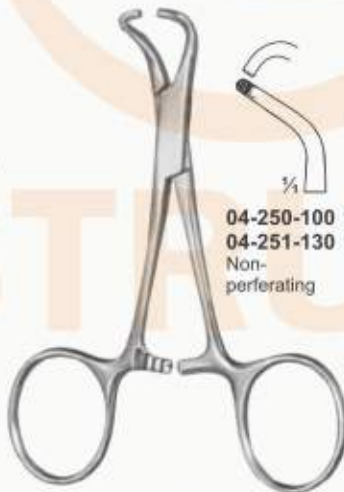

TOHOKU

04-250-100 10cm
 04-251-130 13cm
 Non-perforating



PEERS-BERTMAN

04-252-130
 13.25 cm
 Serrated



BERNHARD
 04-253-165
 16.5 cm

HAEMOSTATIC FORCEPS

Arterienklemmen Pinzas Hemostaticas
 Pincas Hemostatiques Pinze Emostatiche

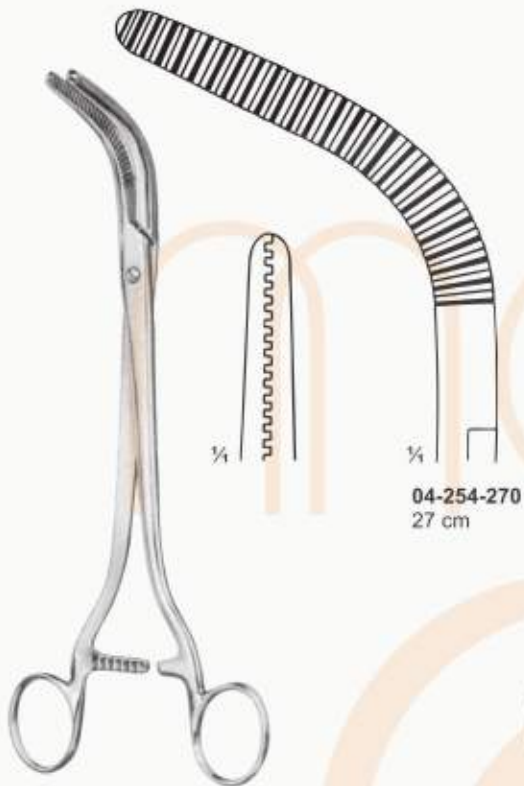

04-254-270
27 cm

WERTHEIM

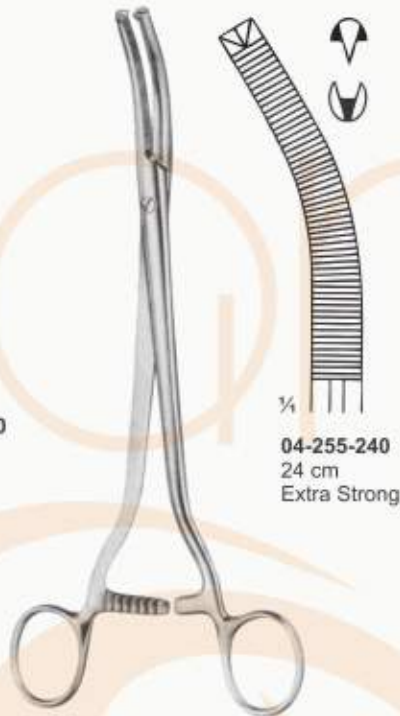

04-255-240
24 cm
Extra Strong

WERTHEIM 1:2

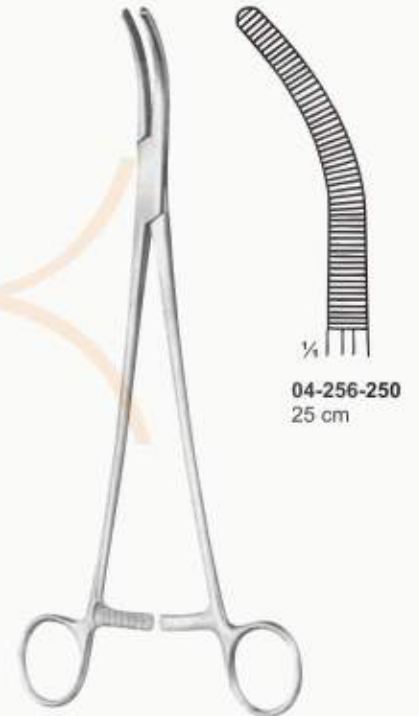

04-256-250
25 cm

WERTHEIM



04-257-230
23 cm
slightly curved

WERTHEIM 1:2



04-258-230
23 cm
more curved



04-259-215
21.5 cm

WERTHEIM-CULLEN

INSTRUMENTS

HAEMOSTATIC FORCEPS

Arterienklemmen
Pinces Hemostatiques

Pinzas Hemostaticas
Pinze Emostatiche



04-260-165 16.5 cm
04-261-180 18 cm
Straight, Smooth

PRESBYTERIAN

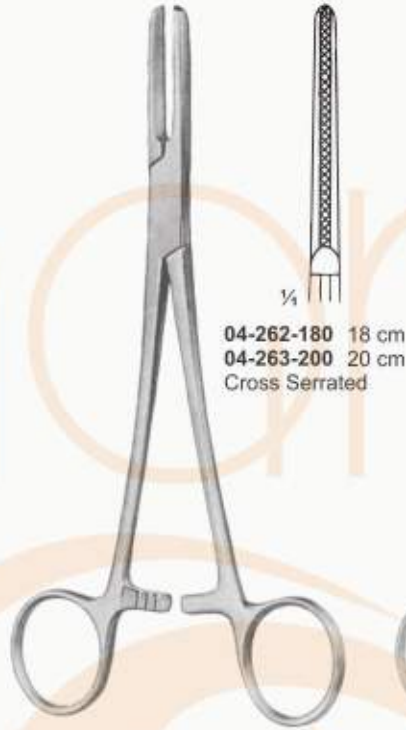

04-262-180 18 cm
04-263-200 20 cm
Cross Serrated

TUBING

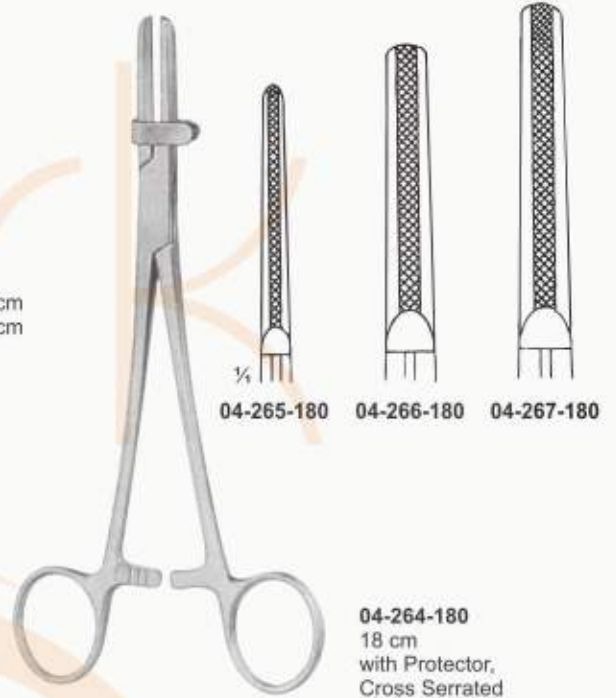

04-265-180 04-266-180 04-267-180

04-264-180
18 cm
with Protector,
Cross Serrated

TUBING CLIP



04-268-145
14.5 cm
with long ratchet

KLINIKUM BERLIN



04-269-160 16 cm
04-270-200 20 cm

FERGUSSON



04-271-160 16cm
04-272-200 20cm

FERGUSSON

HAEMOSTATIC FORCEPS

Arterienklemmen Pinzas Hemostaticas
 Pincas Hemostatiques Pinze Emostatiche

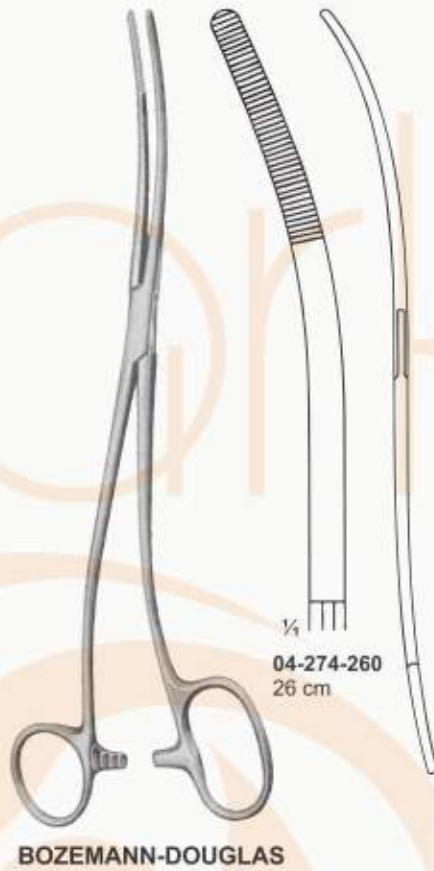

HAEMOSTATIC FORCEPS

Arterienklemmen Pinzas Hemostaticas
Pincas Hemostatiques Pinze Emostatiche



FOERSTER-BALLENGER



¼
04-279-170
17.75 cm
Straight, serrated



04-280-255
25.5 cm
Straight, serrated



04-281-200
20.25 cm
Straight, serrated



04-282-255
25.5 cm
Straight, Smooth



04-283-200
20.25 cm
Curved, serrated



04-284-255
25.5 cm
Curved, serrated



04-285-170
17.75 cm
Curved, serrated



04-286-255
25.5 cm
Curved, Smooth



HEYWOOD-SMITH



¼
04-287-210
21 cm
Spread,
serrated



COLLIN



04-288-160
16 cm



HEYWOOD-SMITH

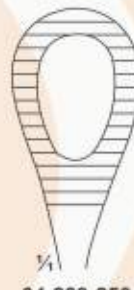

¼
04-289-250
25 cm



RAMPLEY



¼
04-290-250
18 cm



04-291-250
25 cm

HAEMOSTATIC FORCEPS

Arterienklemmen
 Pincas Hemostaticas

Pinzas Hemostaticas
 Pinze Emostatiche

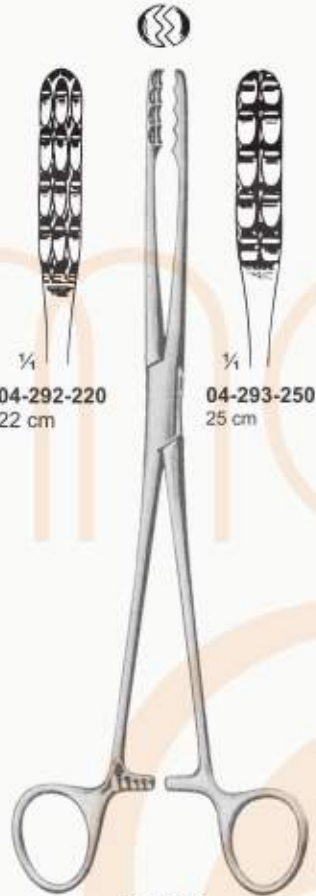

04-292-220
22 cm

04-293-250
25 cm

ULRICH



04-294-220
22 cm

04-295-250
25 cm

ULRICH

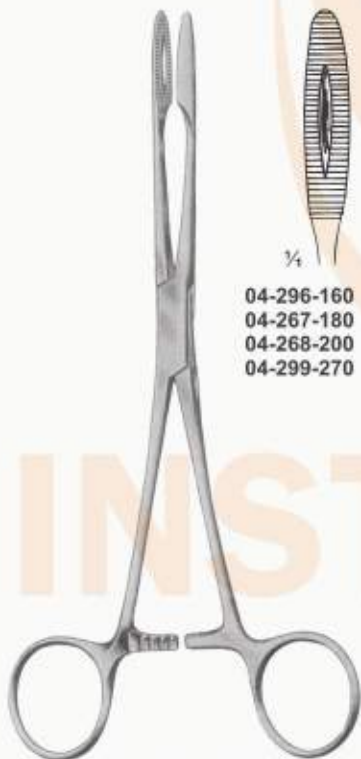

04-296-160 16 cm
 04-267-180 18 cm
 04-268-200 20 cm
 04-299-270 27 cm

GROSS-MAIER



04-300-160 16 cm
 04-301-180 18 cm
 04-302-200 20 cm
 04-303-270 27 cm

GROSS-MAIER



HEYWOOD SMITH
 04-304 -250
 25 cm

HAEMOSTATIC FORCEPS

Arterienklemmen Pinzas Hemostaticas
Pincas Hemostatiques Pinze Emostatiche

mark



¼
04-305-240
24 cm

FLETCHER

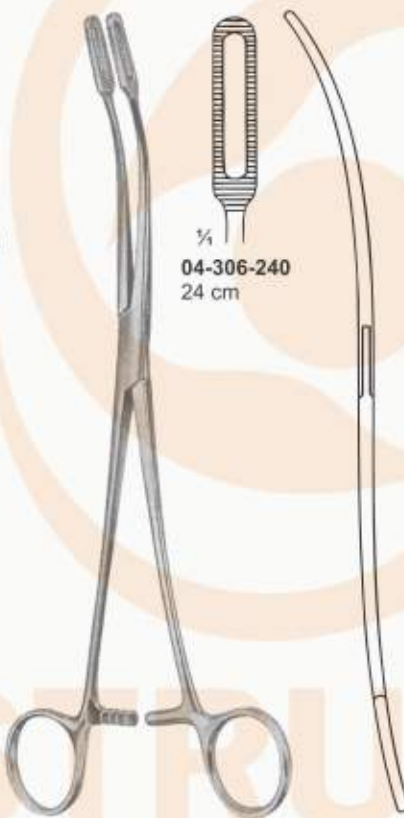

¼
04-306-240
24 cm

FLETCHER



¼
04-307-250
25 cm

FOERSTER-BALLENGER



¼
04-308-250
25 cm

HAEMOSTATIC FORCEPS

Arterienklemmen Pinzas Hemostaticas
Pinces Hemostatiques Pinze Emostatiche



DUPLAY



DUPLAY



CHERON



COLLIN



NOTO



KELLY

INSTRUMENTS

HAEMOSTATIC FORCEPS

INSTRUMENTS

Arterienklemmen
 Pincas Hemostaticas
 Pinces Hemostatiques

Pinzas Hemostaticas
 Pinze Emostatiche



TUFFIER
 04-315-130
 13.0 cm

CHAPUT
 04-316-130
 13.0 cm

PENNINGTON / SIEZING

04-317-155
 15.5 cm
 Straight, 16 mm

04-318-200
 20 cm
 Straight, 22 mm



PRATT

MARTEL
 04-320-140
 14.0 cm

WILLET-MARTEL
 04-321-190
 19.0 cm

STERILIZING FORCEPS

Sterilisieren Zange
Pinzas de esterización

Pinces stérilisation
Pinze di sterilizzazione



DAVIS
04-322-240
24 cm

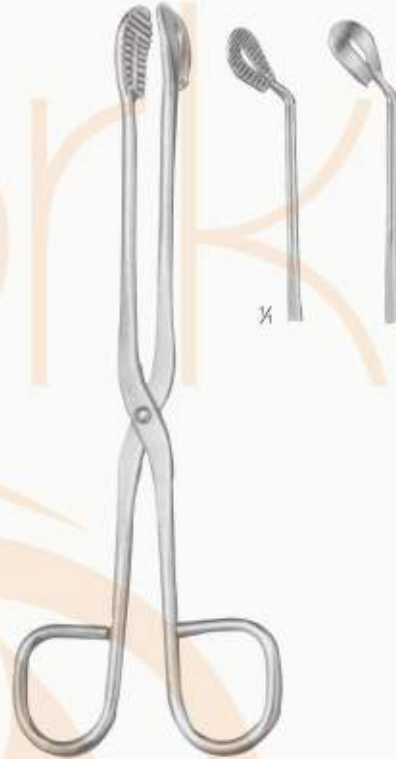

04-323-200
20.0 cm



04-324-300
30.0 cm



ROGGE
04-325-270
27.0 cm



CHEATEL
04-326-270
27.0 cm

SECTION - 05

DRESSING & TISSUE FORCEPS



DRESSING FORCEPS TISSUE FORCEPS

Anatomische pinzetten, chirurgische pinzetten
Pinzas de disección, pinzas de disección condientes

Pinces à dissection, pincés à griffes
Pinze Anatomiche per dissezion, pinze chirurgiche a dentitidopo



**ADSON /
MICRO-ADSON**



05-237-120
12 cm
dressing, serrated



05-238-120
12 cm
dressing,
Micro serrated



05-239-120
12 cm
dressing, serrated
tungsten carbide



05-240-120
12 cm
Tissue,
1:2 Teeth



05-241-120
12 cm
Tissue, Micro 1:2 Teeth
05-242-120
12 cm
Tissue, 2:3 Teeth



ADSON-BROWN



05-243-120
12 cm
Tissue, 7:7 Teeth



05-244-120
12 cm
Tissue, 9:9 Teeth



ADSON-BROWN
05-245-120 12 cm



BROWN

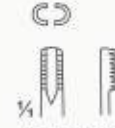

05-246-150
15 cm
Straight, 9:9 Teeth

INSTRUMENTS

DRESSING FORCEPS TISSUE FORCEPS

Anatomische pinzetten, chirurgische pinzetten
Pinzas de disección, pinzas de disección condientes

Pinces à dissection, pincés à griffes
Pinze Anatomiche per dissezion, pinze chirurgiche a dentiditopo

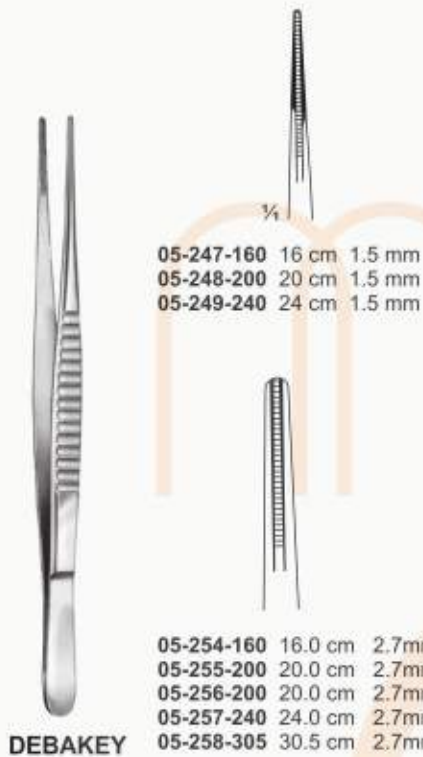

05-247-160 16 cm 1.5 mm
05-248-200 20 cm 1.5 mm
05-249-240 24 cm 1.5 mm

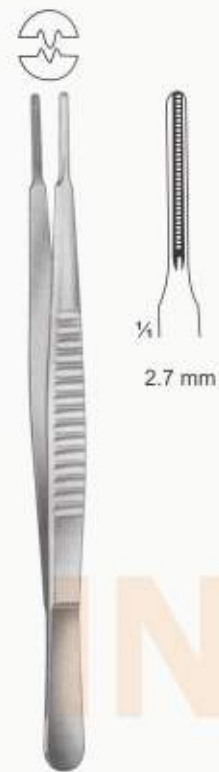
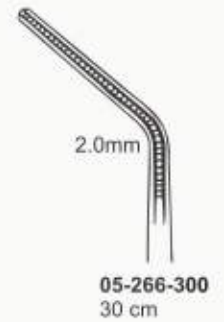
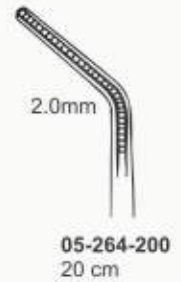
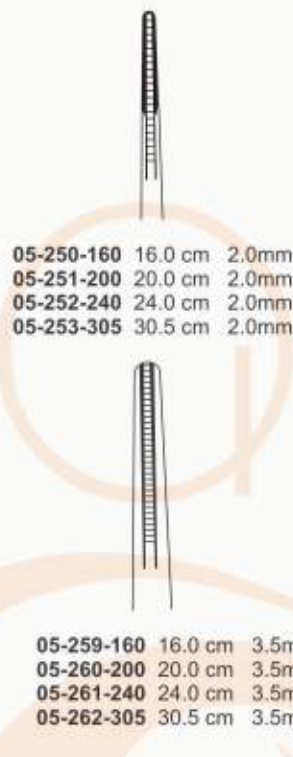
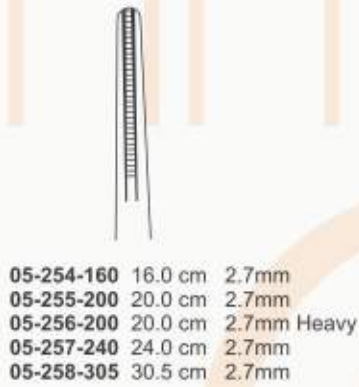

05-279-180 18 cm
05-280-210 21 cm



05-281-180 18 cm
05-282-210 21 cm

05-267-150 15 cm
05-268-200 20 cm
05-269-240 24 cm
05-270-300 30 cm

05-271-150 15 cm
05-272-200 20 cm
05-273-240 24 cm
05-274-300 30 cm

05-275-150 15 cm
05-276-200 20 cm
05-277-240 24 cm
05-278-300 30 cm



MICRO FORCEPS

Mikropinzetten
Micro-Pinças
Micro-Pinzes
Micro-Pinze

INSTRUMENTS



MICRO FORCEPS
05-283-140
14.0 cm



MICRO FORCEPS
05-284-140 1:2
14.0 cm



MICRO FORCEPS
05-285-140 1:2
14.0 cm



MICRO FORCEPS
05-286-140 14.0 cm
05-287-180 18.0 cm



0.3 mm
05-288-120
12.0 cm
Str.



0.3 mm
05-289-150
15.0 cm
Cvd.



05-290-180
Str.



05-291-180
Cvd.

MICRO FORCEPS

MICRO FORCEPS
18.0 cm



05-292-110
11.0 cm

STEVENS 1:2



05-293-110
11.0 cm

STEVENS 1:2

MICRO FORCEPS, TISSUE FORCEPS

Mikropinzetten, Pinzas para tejidos
 Micro-Pinzas, Pinze per tessuti

Micro-Pinças, Pinças a tecido
 Micro-Pinze, Gewebe



GRAEFE
 7.0 cm
 0.5 mm 05-294-070
 0.7 mm 05-295-070
 1.0 mm 05-296-070

GRAEFE
 7.0 cm
 05-297-070
 05-298-070
 05-299-070

GRAEFE 1:2
 7.0 cm
 05-300-070
 05-301-070
 05-302-070

GRAEFE 1:2
 7.0 cm
 05-303-070
 05-304-070
 05-305-070



05-306-105



05-307-105



05-308-105



05-309-105



05-310-105



05-311-105



7.0 cm
 10.0 cm



05-312-070
 05-313-100



05-314-070
 05-315-100



05-316-070
 05-317-100



7.0 cm
 10.0 cm

05-318-070
 05-319-100



05-320-070
 05-321-100



05-322-070
 05-323-100

STEVENS
 10.5 cm

GRAEFE

JEWELER TYPE, DISSECTING FORCEPS

Chirurgische pinzetten, Uhrmacher-Pinzetten

Pinzas de disección con dientes, Pinzas de relojero

Pinces à dissection à groffes, Pinces d'horloger

Pinze per dissezione con denti, Pinze de orologiaio



05-324-001

05-325-002

05-326-003

05-327-004

05-328-005

05-329-006

05-330-007

05-331-008



JEWELER'S
 05-332-115 11.5 cm



$\frac{1}{4}$
 05-333-115
 10.5 cm



05-334-105
 10.5 cm



05-335-110
 11 cm



05-336-110
 11 cm



$\frac{1}{4}$
 05-337-110
 11 cm



05-338-120
 12 cm



05-339-120
 12 cm



05-340-120
 12 cm

CILIA FORCEPS

Cilienpinzetten *Pinces à épiler les cils*
Pinzas depilatorias *Pinze depilatoria*

INSTRUMENTS



KUEHNE
 05-341-105
 10.5 cm



KUEHNE
 05-342-105
 10.5 cm



LITTAUER
 05-343-085
 8.5 cm



LITTAUER
 05-344-090
 9 cm



BARRAQUER
 05-345-105
 10.5 cm



ZIEGLER
 05-346-090
 9 cm



DOUGLAS
 05-347-090
 9 cm



BEER
 05-348-090
 9 cm

SPLINTER FORCEPS

Splitterpinzetten *Pinces à échardes*
Pinzas Para espinas *Pinze per scheggie*



FEILCHENFELD

$\frac{1}{4}$
05-349-075
7.5 cm
05-350-090
9 cm
05-351-110
11 cm



HUNTER

$\frac{1}{4}$
05-352-105
10.5 cm



HUNTER

$\frac{1}{4}$
05-353-105
10.5 cm



CARMALT

$\frac{1}{4}$
05-354-105
10.5 cm



CARMALT

$\frac{1}{4}$
05-355-105
10.5 cm



$\frac{1}{4}$
05-356-080
8 cm
05-357-090
9 cm
05-358-105
10.5 cm
05-359-115
11.5 cm
05-360-125
12.5 cm
05-361-145
14.5 cm



$\frac{1}{4}$
05-362-080
8 cm
05-363-090
9 cm
05-364-105
10.5 cm
05-365-115
11.5 cm
05-366-125
12.5 cm
05-367-145
14.5 cm



$\frac{1}{4}$
05-368-080
8 cm
05-369-090
9 cm
05-370-105
10.5 cm
05-371-115
11.5 cm
05-372-125
12.5 cm
05-373-145
14.5 cm



$\frac{1}{4}$
05-374-080
8 cm
05-375-090
9 cm
05-376-105
10.5 cm
05-377-115
11.5 cm
05-378-125
12.5 cm
05-379-145
14.5 cm

SPLINTER FORCEPS

INSTRUMENTS

Splitterpinzetten *Pinces à échardes*
Pinzas Para espinas *Pinze per scheggie*



- 05-380-080 08.0 cm
- 05-381-090 09.0 cm
- 05-382-105 10.5 cm
- 05-383-115 11.5 cm
- 05-384-125 12.5 cm
- 05-385-145 14.5 cm



- 05-386-080 08.0 cm
- 05-387-090 09.0 cm
- 05-388-105 10.5 cm
- 05-389-115 11.5 cm
- 05-390-125 12.5 cm
- 05-391-145 14.5 cm



- 05-392-080 08.0 cm
- 05-393-090 09.0 cm
- 05-394-105 10.5 cm
- 05-395-115 11.5 cm
- 05-396-125 12.5 cm
- 05-397-145 14.5 cm



- 05-398-080 08.0 cm
- 05-399-090 09.0 cm
- 05-400-105 10.5 cm
- 05-401-115 11.5 cm
- 05-402-125 12.5 cm
- 05-403-145 14.5 cm



- STIEGLITZ
 FORCEPS**
 05-404-125
 12.5 cm



- STIEGLITZ**
 05-405-135 13.5 cm Str.
 05-406-135 13.5 cm Cvd.

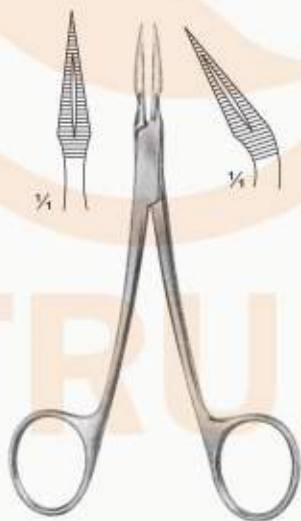

- STIEGLITZ**
 05-407-135 13.5 cm Str.
 05-408-135 13.5 cm Cvd.



- PEET**
 05-409-115
 11.5 cm

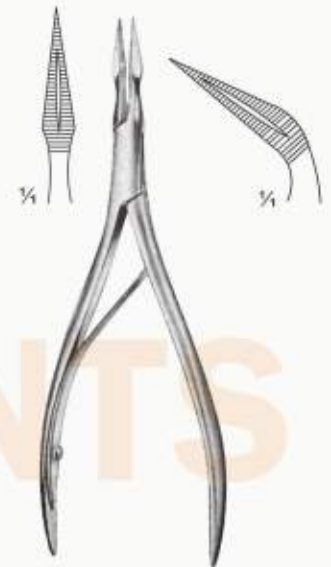

- RALK**
 05-410-150 15 cm Str.
 05-411-150 15 cm Cvd.

DRESSING FORCEPS, TISSUE FORCEPS T.C.

Anatomische pinzetten, chirurgische pinzetten

Pinces à dissection, pincés à griffes

Pinzas de disección, pinzas de disección condientes

Pinze Anatomiche per dissezion, pinze chirurgiche a dentiditopo



STANDARD

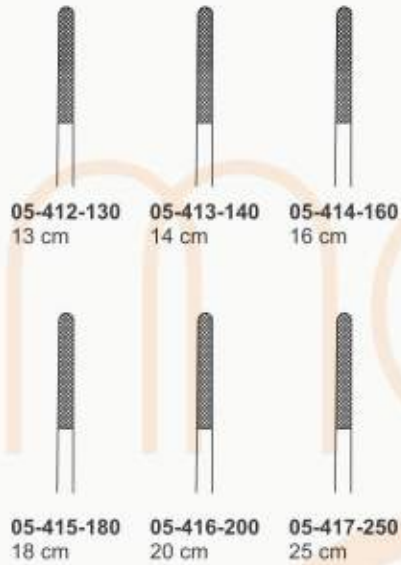

STANDARD

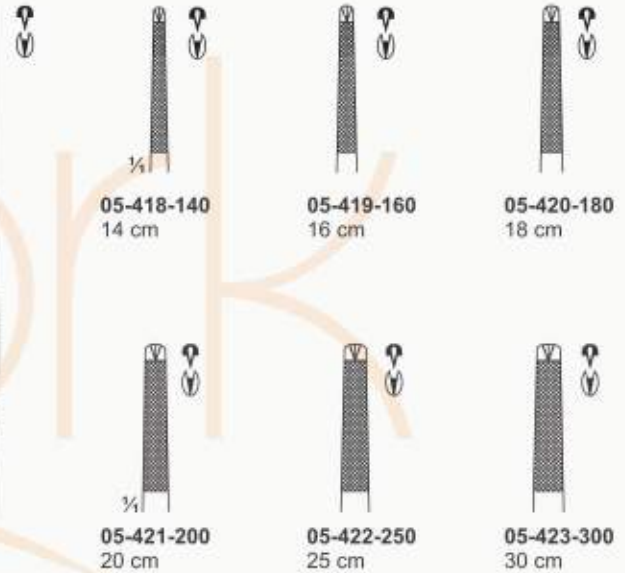

STANDARD
 05-424-140 14 cm
 05-425-160 16 cm



ADSON



INSTRUMENTS

DRESSING FORCEPS, TISSUE FORCEPS T.C.

Anatomische pinzetten, chirurgische pinzetten
Pinzas de disección, pinzas de disección condientes

Pinces à dissection, pincés à griffes
Pinze Anatomiche per dissezion, pinze chirurgiche a dentitidopo



BONNEY DISSECTING



05-431-180
18 cm
Straight Tungsten
Carbide, X-Serrations
1:2 Teeth



05-432-180
18 cm
Straight, Serrated-
1:2 Teeth



05-433-180
18 cm
Straight, Serrated-
2:3 Teeth



WANGENSTEEN



05-434-152
15.2 cm



05-435-229
22.9 cm



05-436-254
25.4 cm



WANGENSTEEN
05-437-150 15 cm
05-438-230 23 cm
05-439-250 25 cm



WAUGH
05-440-178 15.0 cm
05-441-178 17.8 cm
05-442-203 20.3 cm
05-443-229 22.9 cm
05-444-241 24.1 cm
05-445-267 26.7 cm



POTTS-SMITH
05-446-160 16 cm
05-447-180 18 cm
05-448-210 20 cm
05-449-240 25 cm
05-450-260 26 cm



CUSHING
05-451-180
18 cm



CUSHING



05-452-180
18 cm
Dressing w/Pin,
Serrated



05-453-180
18 cm
Tungsten carbide
Cross Serrated



05-454-180
18 cm
Tissue w/Pin,
1:2 Teeth



CUSHING
05-455-180
18 cm



DRESSING FORCEPS TISSUE FORCEPS

Anatomische pinzetten, chirurgische pinzetten

Pinces à dissection, pincés à griffes

Pinzas de disección, pinzas de disección condientes

Pinze Anatomiche per dissezion, pinze chirurgiche a dentitidopo



STANDARD



05-001-105
10.5 cm



05-002-115
11.5 cm



05-003-130
13.0 cm



05-004-145
14.5 cm



05-005-160
16.0 cm



05-006-180
18.0 cm



05-007-200
20.0 cm



05-008-250
25.0 cm

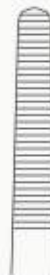

05-009-300
30.0 cm



1:2
STANDARD



05-010-105
10.5 cm



05-011-115
11.5 cm



05-012-130
13.0 cm



05-013-145
14.5 cm



05-014-160
16.0 cm



05-015-180
18.0 cm



05-016-200
20.0 cm



05-017-250
25.0 cm



05-018-300
30.0 cm

DRESSING FORCEPS TISSUE FORCEPS

Anatomische pinzetten, chirurgische pinzetten

Pinces à dissection, pincés à griffes

Pinzas de disección, pinzas de disección condientes

Pinze Anatomiche per dissezion, pinze chirurgiche a dentititopo



STANDARD

05-019-115	11.5 cm
05-020-130	13.0 cm
05-021-145	14.5 cm
05-022-160	16.0 cm
05-023-180	18.0 cm
05-024-200	20.0 cm
05-025-250	25.0 cm
05-026-300	30.0 cm



STANDARD

05-027-115	11.5 cm
05-028-130	13.0 cm
05-029-145	14.5 cm
05-030-160	16.0 cm
05-031-180	18.0 cm
05-032-200	20.0 cm
05-033-250	25.0 cm
05-034-300	30.0 cm



STANDARD CROSS TEETH

05-035-130	13.0 cm
05-036-145	14.5 cm
05-037-180	18.0 cm

Cross Teeth



STANDARD FINE

05-038-130	14.5 cm
05-039-145	13.0 cm



STILLE

05-040-180	15.0 cm
------------	---------



MOD. MARTIN

05-041-130	13.0 cm
05-042-145	14.5 cm



Mod. USA

05-043-120	12.0 cm
05-044-130	13.0 cm
05-045-145	14.5 cm
05-046-155	15.5 cm
05-047-180	18.0 cm
05-048-210	21.0 cm
05-049-250	25.0 cm
05-050-310	31.0 cm



Mod. USA

05-051-120	12.0 cm
05-052-130	13.0 cm
05-053-145	14.5 cm
05-054-155	15.5 cm
05-055-180	18.0 cm
05-056-210	21.0 cm
05-057-250	25.0 cm
05-058-310	31.0 cm

DRESSING FORCEPS TISSUE FORCEPS

INSTRUMENTS

Anatomische pinzetten, chirurgische pinzetten
 Pinzas de disección, pinzas de disección condientes

Pinces à dissection, pincés à griffes
 Pinze Anatomiche per dissezion, pinze chirurgiche a dentiditopo



POTTS-SMITH
 05-059-180 18 cm
 05-060-210 20 cm
 05-061-250 25 cm

POTTS-SMITH
 05-062-180 18 cm
 05-063-210 21 cm
 05-064-250 25 cm

BROPHY
 05-065-200
 20 cm

BROPHY
 05-066-200
 20 cm

WANGENSTEEN
 05-067-250
 25 cm

GERALD 1 : 2
 05-068-180
 18 cm

GERALD
 1 : 2
 05-069-145
 14.5 cm



CUSHING
 05-070-145
 14.5 cm

CUSHING
 1 : 2
 05-071-145
 14.5 cm

POTTS-SMITH
 1 : 2
 05-072-150 15 cm
 05-073-180 18 cm
 05-074-200 20 cm
 05-075-250 25 cm

POTTS-SMITH
 1 : 2
 05-076-150 15 cm
 05-077-180 18 cm
 05-078-200 20 cm
 05-079-250 25 cm

BROPHY
 1 : 2
 05-080-160
 16 cm

BROPHY
 1 : 2
 05-081-160
 16 cm

DRESSING FORCEPS TISSUE FORCEPS

INSTRUMENTS

Anatomische pinzetten, chirurgische pinzetten
 Pinzas de disección, pinzas de disección condientes

Pinces à dissection, pincès à griffes
 Pinze Anatomiche per dissezion, pinze chirurgiche a dentitidopo



GERALD
 05-082-180
 18 cm



GERALD
 05-083-180
 18 cm



CUSHING
 05-084-175
 17.5 cm



CUSHING
 05-085-175
 17.5 cm



SEMKEN
 05-086-125 12.5 cm
 05-087-155 15.5 cm



SEMKEN
 05-088-125 12.5 cm
 05-089-155 15.5 cm



TAYLOR
 05-090-175
 17.5 cm



TAYLOR
 05-091-175
 17.5 cm



TAYLOR
 05-092-175
 17.5 cm



TAYLOR
 05-093-175
 17.5 cm

DRESSING FORCEPS TISSUE FORCEPS

Anatomische pinzetten, chirurgische pinzetten

Pinces à dissection, pincés à griffes

Pinzas de disección, pinzas de disección condientes

Pinze Anatomiche per dissezion, pinze chirurgiche a dentiditopo



STONE
4:5

05-094-150
15 cm

LERCHE
5:6

05-095-150
15 cm

ADLERKREUTZ
2:3

05-096-150 15 cm
05-097-200 20 cm

ADLERKREUTZ
4:5

05-098-150 15 cm
05-099-200 20 cm

GILLIES
1:2

05-100-150
15 cm



SEMKEN
1:2

05-101-125 12.5 cm
05-102-150 15.0 cm

SEMKEN
1:2

05-103-125 12.5 cm
05-104-150 15.0 cm

TAYLOR
1:2

05-105-175
17.5 cm

TAYLOR
1:2

05-106-175
17.5 cm

TAYLOR
1:2

05-107-175
17.5 cm

DRESSING FORCEPS TISSUE FORCEPS

Anatomische pinzetten, chirurgische pinzetten

Pinces à dissection, pincés à griffes

Pinzas de disección, pinzas de disección condientes

Pinze Anatomiche per dissezion, pinze chirurgiche a dentitidopo



STILLE
1:2

05-108-150 15 cm



STILLE
2:3

05-109-150 15 cm



1:2

05-110-120 12.0 cm
05-111-130 13.0 cm
05-112-145 14.5 cm
05-113-155 15.5 cm
05-114-185 18.5 cm
05-115-210 21.0 cm
05-116-250 25.0 cm
05-127-300 30.0 cm



2:3

05-118-130 13.0 cm
05-119-145 14.5 cm
05-120-155 15.5 cm



3:4

05-121-130 13.0 cm
05-122-145 14.5 cm
05-123-155 15.5 cm



4:5

05-124-130 13.0 cm
05-125-145 14.5 cm
05-126-155 15.5 cm



2:3

STANDARD

05-127-115 11.5 cm
05-128-130 13.0 cm
05-129-145 14.5 cm
05-130-160 16.0 cm
05-131-180 18.0 cm
05-132-200 20.0 cm
05-133-250 25.0 cm
05-134-300 30.0 cm



3:4

05-135-130 13.0 cm
05-136-145 14.5 cm
05-137-160 16.0 cm



4:5

05-138-130 13.0 cm
05-139-145 14.5 cm
05-140-160 16.0 cm



1:2

STANDARD FINE

05-141-130 13.0 cm
05-142-145 14.5 cm
05-143-160 16.0 cm
05-144-200 20.0 cm



1:2

05-145-130 13.0 cm
05-146-145 14.5 cm



1:2

05-147-130 13.0 cm
05-148-145 14.5 cm

DRESSING FORCEPS TISSUE FORCEPS

INSTRUMENTS

Anatomische pinzetten, chirurgische pinzetten
 Pinzas de disección, pinzas de disección condientes

Pinces à dissection, pincés à griffes
 Pinze Anatomiche per dissezion, pinze chirurgiche a dentiditopo



TREVES
 05-149-125 12.5 cm
 05-150-150 15.0 cm
 05-151-180 18.0 cm
 Dissecting Forceps
 teeth, on smooth jaws.



CHARNLEY
 05-152-145 14.5 cm
 05-153-180 18.0 cm
 Dissecting Forceps
 one into two teeth,
 block on jaws.



RAMSAY
 05-154-180 18.0 cm
 Dissecting Forceps
 non-tooth serrated jaws.



RAMSAY
 05-155-180 18.0 cm
 Dissecting Forceps
 one into teeth on
 serrated jaws.
 As above but into
 three teeth.



T.O.E
 05-156-125 12.5 cm
 05-157-150 15.0 cm
 05-158-180 18.0 cm
 Dissecting Forceps
 turn over end,
 serrated jaws.



BLOCK END
 05-159-125 12.5 cm
 05-160-150 15.0 cm
 05-161-180 18.0 cm
 05-162-200 20.0 cm
 Dissecting Forceps
 block end, serrated
 jaws.



MCINDOE
 05-163-150 15.0 cm
 Dissecting Forceps
 non-toothed,
 serrated jaws.



JEAN
 05-164-140 14.0 cm
 05-165-180 18.0 cm
 Dissecting Forceps
 one into two teeth on
 serrated jaws.



WAUGH
 05-166-150 15.0 cm
 05-167-180 18.0 cm
 Dissecting Forceps
 slightly heavier
 non-toothed,
 serrated jaws.



WAUGH
 05-168-150 15.0 cm
 05-169-180 18.0 cm
 Dissecting Forceps
 as above but one
 two tooth on
 serrated jaws.
 Known as Scott.



LEEDHAM
 05-170-145 14.5 cm
 05-171-180 18.0 cm
 Green Dissecting
 Forceps
 two three teeth, smooth jaws.

DRESSING FORCEPS TISSUE FORCEPS

Anatomische pinzetten, chirurgische pinzetten
Pinzas de disección, pinzas de disección condientes

Pinces à dissection, pincés à griffes
Pinze Anatomiche per dissezion, pinze chirurgiche a dentiditopo

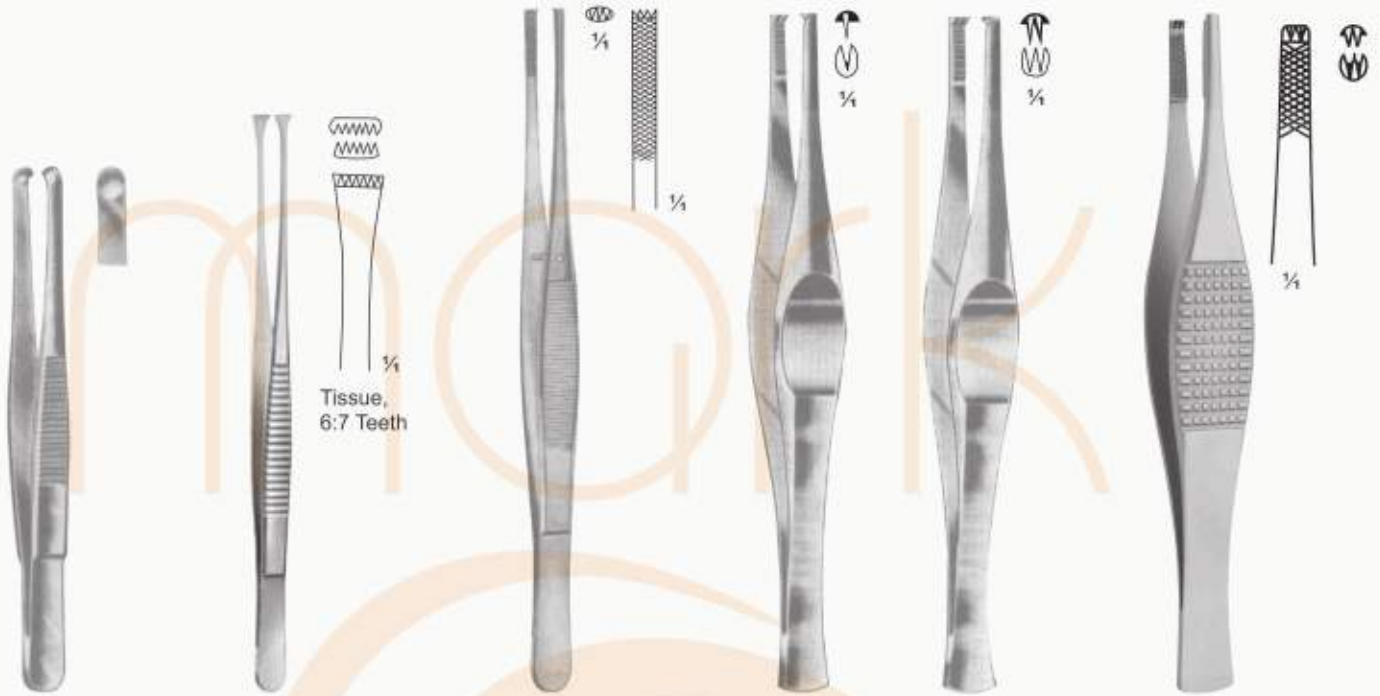

DURANTE

05-172-145 14.5 cm
05-173-160 16.0 cm
05-174-200 20.0 cm

NELSON

05-175-150
15.0 cm

Tissue,
6:7 Teeth

STILLE-BARRAYA

05-176-180 18.0 cm
05-177-200 20.0 cm
05-178-250 25.0 cm

FERRIS-SMITH

1:2 2:3
05-179-180 05-180-180
18.0 cm 18.0 cm

FERRIS-SMITH

1:2 2:3
05-181-180
18.0 cm

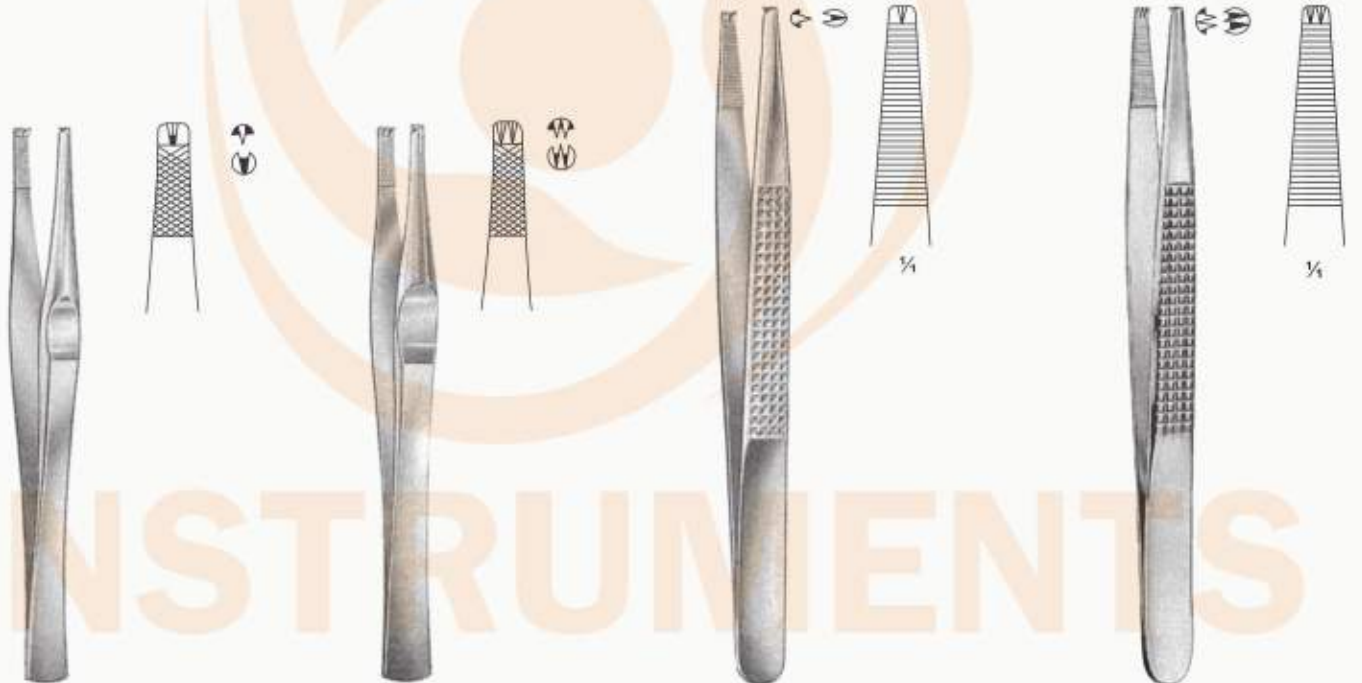

LANE 1:2

05-182-125 12.5 cm
05-183-150 15.0 cm
05-184-170 17.0 cm
05-185-180 18.0 cm
05-186-200 20.0 cm

LANE 2:3

05-187-125 12.5 cm
05-188-150 15.0 cm
05-189-170 17.0 cm
05-190-180 18.0 cm
05-191-200 20.0 cm

BONNEY 1:2

05-192-180
18.0 cm

BONNEY 2:3

05-193-180
18.0 cm

DRESSING FORCEPS TISSUE FORCEPS

Anatomische pinzetten, chirurgische pinzetten

Pinces à dissection, pincés à griffes

Pinzas de disección, pinzas de disección condientes

Pinze Anatomiche per dissezion, pinze chirurgiche a dentiditopo



DUEHRSSEN
05-194-200
20 cm



DUEHRSSEN 1:2
05-195-200
20 cm



DUEHRSSEN 2:3
05-196-200
20 cm



DUEHRSSEN 3:4
05-197-200
20 cm



DUEHRSSEN
05-198-200
20 cm



MAYO-RUSSIAN
05-199-155
15.5 cm
05-200-230
23.0 cm

Grasping, serrated

Grasping, serrated



DAVIS
05-201-250
25 cm



RUSSIAN-MODELL
05-202-150 15 cm
05-203-200 20 cm
05-204-250 25 cm



Grasping, Serrated



Grasping, Serrated



SINGLEY-TUTTLE INTESTINAL
05-206-230
23 cm



Grasping, Serrated



COLLIN-DUVAL



05-207-200
20 cm

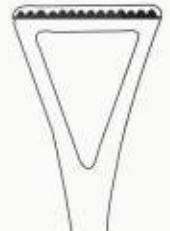

05-208-200
20 cm



05-209-200
20 cm

DRESSING FORCEPS TISSUE FORCEPS

Anatomische pinzetten, chirurgische pinzetten
Pinzas de disección, pinzas de disección condientes

Pinces à dissection, pincés à griffes
Pinze Anatomiche per dissezion, pinze chirurgiche a dentiditopo



05-210-140
14 cm
Dressing, Serrated
05-211-160
16cm
Dressing, Serrated

LUCAE



05-212-160
16 cm
Bayonet, Serrated
05-213-180
18 cm
Bayonet, Serrated
05-214-200
20 cm
Bayonet, Serrated

JANSSEN-GRUENWALD



MILLER
05-215-150
15 cm



MILLER
05-216-150
15 cm



05-217-240
24.0 cm
3.0 mm

SAMI



05-218-240
24.0 cm
3.0 mm



05-219-220
22.0 cm
3.0 mm

05-220-220
22.0 cm
5.0 mm

Spoon

05-221-220
22.0 cm
3.0 mm

05-222-220
22.0 cm
5.0 mm

Flat

YASARGIL



05-223-220
22.0 cm
3.0 mm

05-224-220
22.0 cm
5.0 mm

Curette

HEIFETZ
22.0 cm

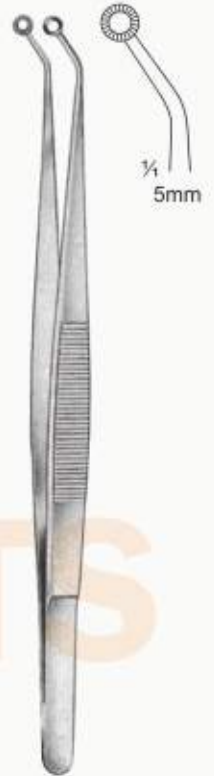

HUNT
05-225-200
20 cm

DRESSING FORCEPS TISSUE FORCEPS

Anatomische pinzetten, chirurgische pinzetten
Pinzas de disección, pinzas de disección condientes

Pinces à dissection, pincés à griffes
Pinze Anatomiche per dissezion, pinze chirurgiche a dentiditopo

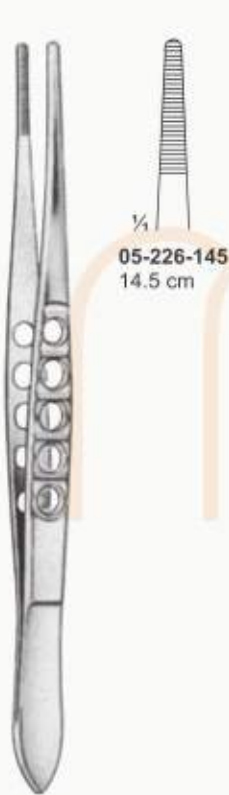

05-226-145
14.5 cm

MODELL USA



05-227-145
14.5 cm

MODELL USA

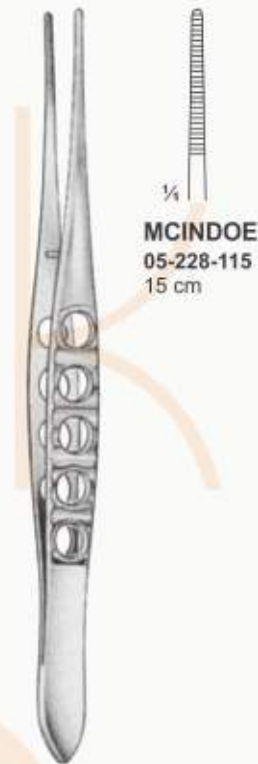

MCINDOE
05-228-115
15 cm

MODELL USA



GILLIES
05-229-150
15 cm



05-230-120
12cm
Dressing,
Micro serrated

ADSON

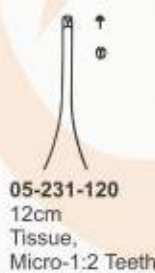

05-231-120
12cm
Tissue,
Micro-1:2 Teeth



DE BAKAY
05-233-160
16 cm
Tissue,
width 1.5mm



05-234-160
16 cm

DE BAKAY



05-235-160
16 cm

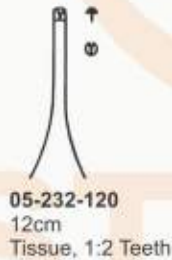

05-232-120
12cm
Tissue, 1:2 Teeth



05-236-160
16 cm

SECTION - 06

NEEDLE HOLDERS



NEEDLE HOLDERS

Nadelhalter Porta-agujas
 Prote-aiguilles Porta aghi



 ¼
06-001-127
 12.7 cm
 Long grooves

CONVERS



 ¼
06-002-127
 12.7 cm
 Serrated

DERF



 ¼
06-003-130
 13 cm
 Smooth

HALSEY

 ¼
06-004-130
 13 cm
 Serrated



 ¼
06-005-127
 12.7 cm
 Smooth

WEBSTER



 ¼
06-006-145
 14.5 cm
 Serrated

BAUMGARTNER



 ¼
06-007-152
 15.2 cm
 Serrated

CRILE-WOOD

NEEDLE HOLDERS

Nadelhalter Porta-agujas
Prote-aiguilles Porta aghi



06-008-160
16 cm
Serrated

CRILE-WOOD



06-009-150
15 cm
Serrated

CRILE-MURRAY



06-010-180
18 cm
Fine-Serrated

ADSON

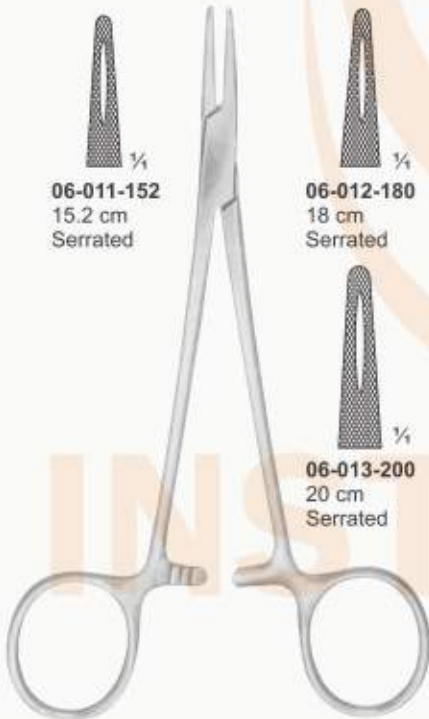

06-011-152
15.2 cm
Serrated

MAYO-HEGAR



06-012-180
18 cm
Serrated



06-013-200
20 cm
Serrated



06-014-152
15.2 cm
Serrated



06-015-180
18 cm
Serrated



06-016-200
20 cm
Serrated



06-017-200
18 cm
Serrated



HEGAR



06-018-200
20 cm
Cvd-Serrated

HEANEY

NEEDLE HOLDERS

Nadelhalter Porta-agujas
 Prote-aiguilles Porta aghi



06-019-230
 23 cm
 Serrated

JAMESON



06-020-275
 27.5 cm
 Serrated

WANGENSTEEN



06-021-270
 27 cm
 Serrated

MASSON



06-022-140
 14 cm
 Serrated

OLSEN-HEGAR



06-023-185
 18.5 cm
 Serrated



06-024-160
 16 cm
 Serrated

GILLIES

NEEDLE HOLDERS

INSTRUMENTS

Nadelhalter Porta-agujas
 Prote-aiguilles Porta aghi

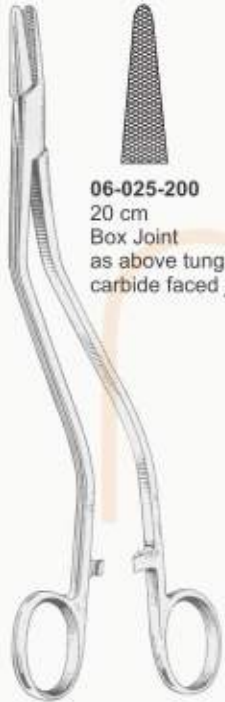

06-025-200
 20 cm
 Box Joint
 as above tungsten
 carbide faced jaws.

THOMSON WALKER

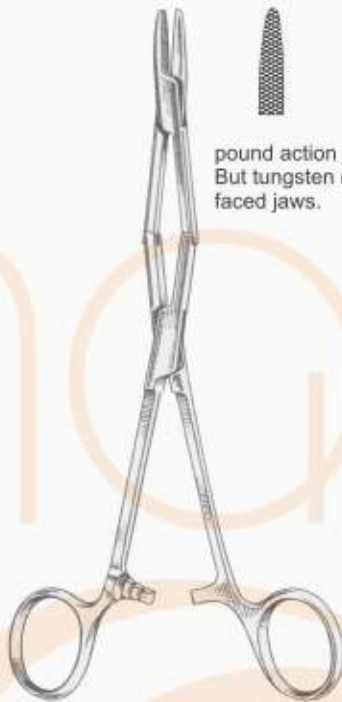

pound action joint.
 But tungsten carbide
 faced jaws.

NAUNTON MORGAN
06-026-180 18 cm
06-027-250 25 cm

NAUNTON MORGAN

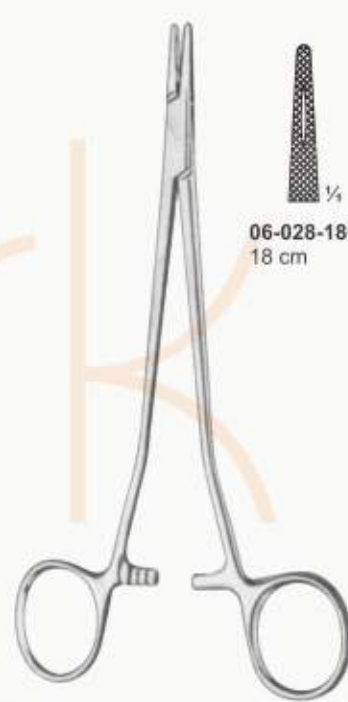

06-028-180
 18 cm

06-029-260
 26 cm

SAROT



FINOCCHIETTO
06-030-270
 27 cm

FINOCCHIETTO



COLLIER
06-031-125
 12.5 cm

COLLIER



06-032-130
 13 cm

06-033-130
 13 cm

HALSEY

NEEDLE HOLDERS

Nadelhalter Porta-agujas
Prote-aiguilles Porta aghi

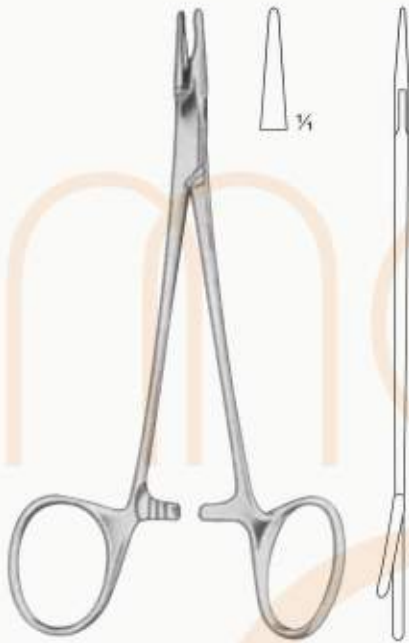

NEIVERT
06-034-130
13 cm

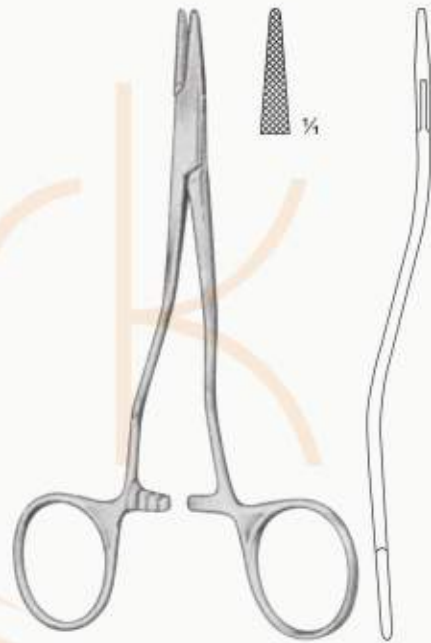

KILNER
06-035-130
13 cm



MATHIEU

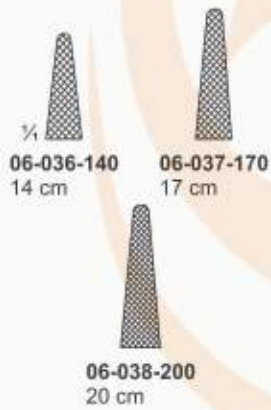

MAYO ROCHESTER
06-039-180 18 cm
06-040-230 23 cm
button release, screw joint.



MACPHAIL
06-041-150 15 cm
06-042-180 18 cm
06-043-200 20 cm
lined with copper.

NEEDLE HOLDERS

Nadelhalter Porta-agujas
Prote-aiguilles Porta aghi

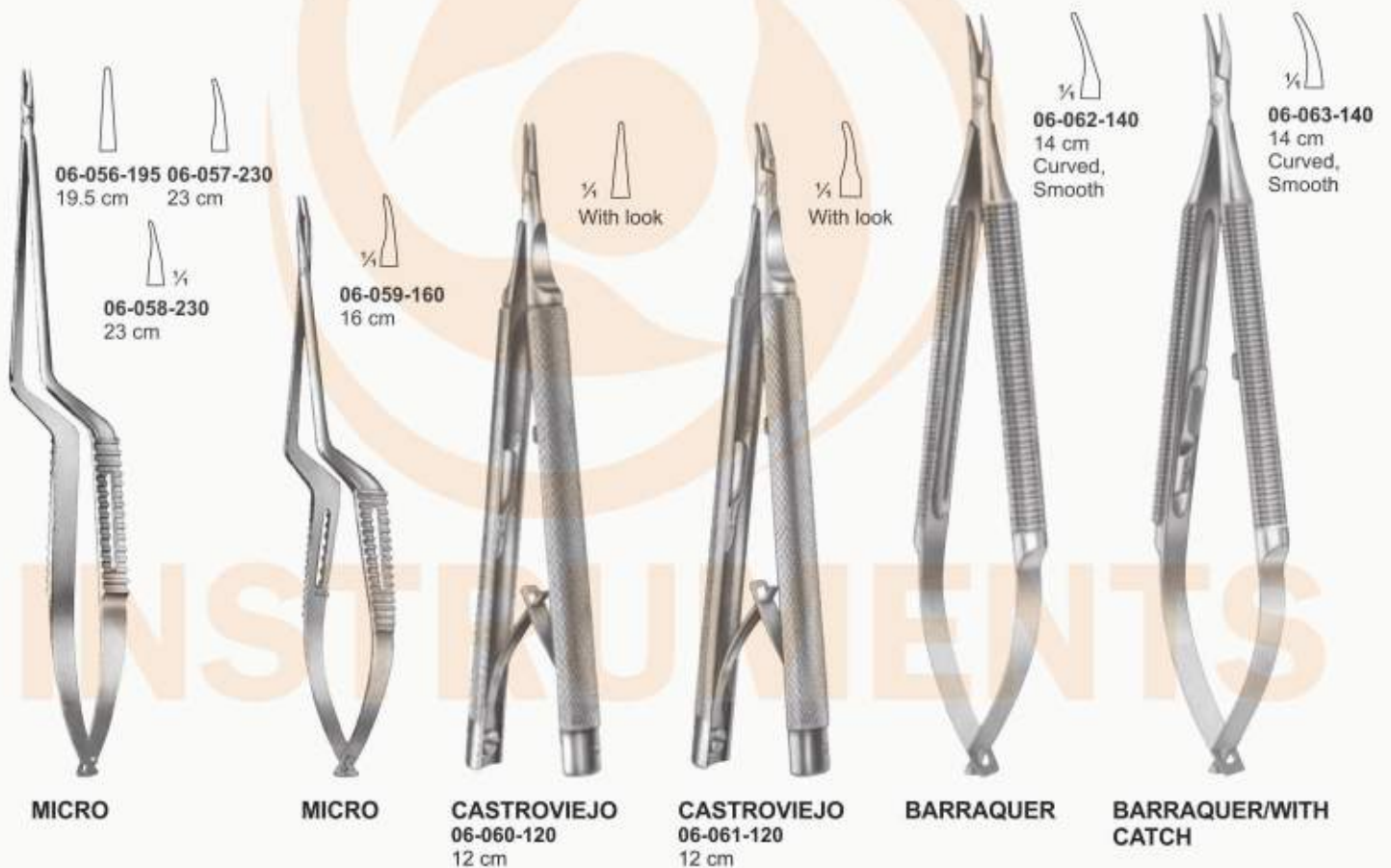
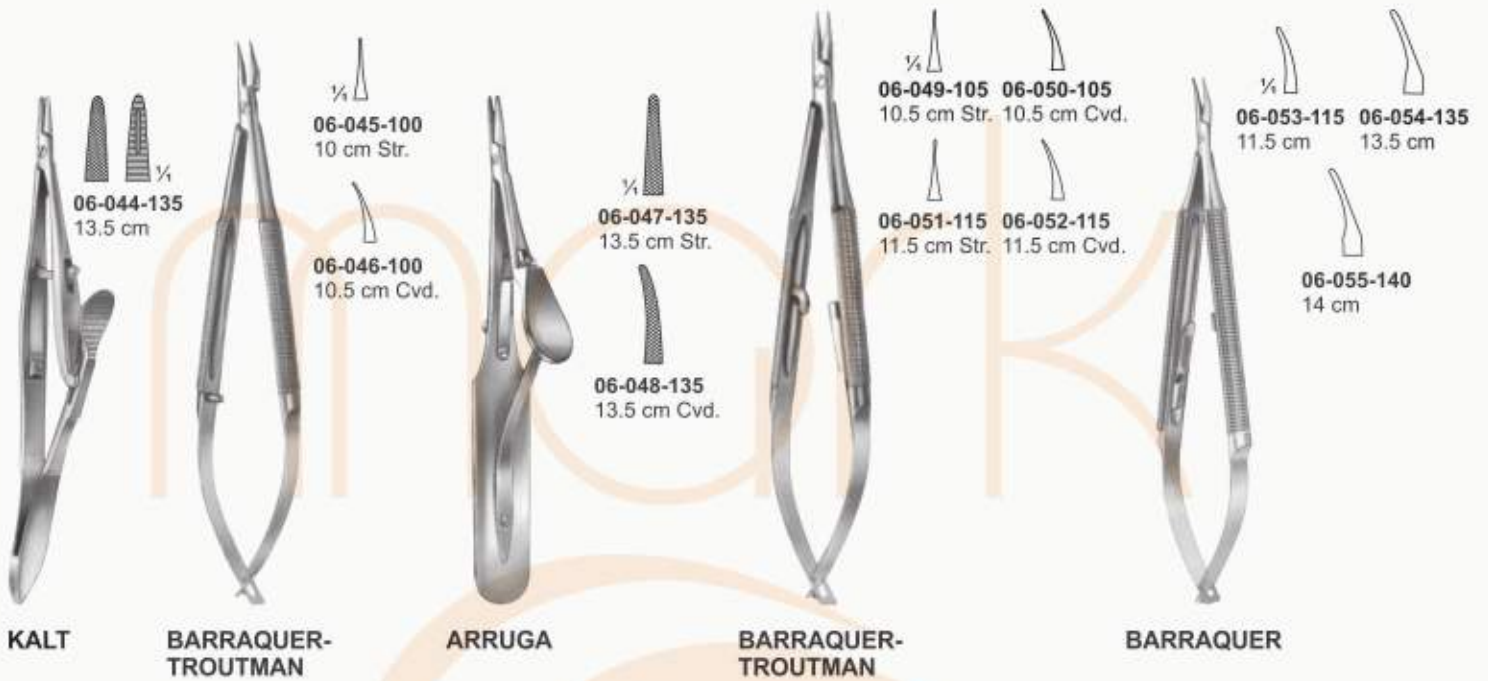

REVERDIN NEEDLES

INSTRUMENTS

Reverdin nadeln Aguilles de reverdin
 agujas de reverdin aghi di reverdin



YOUNG
 06-064-245
 24.5 cm
 Complete
 with on
 Needle no. 01

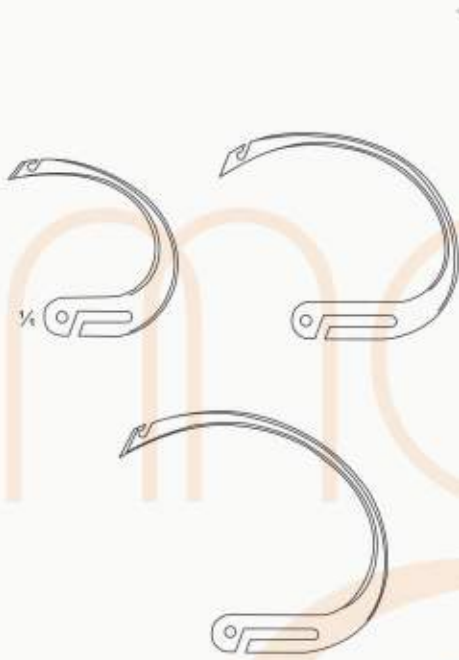

SCHMIEDEN-DICK
 06-065-290
 29 cm
 malleable



SCHMIEDEN-DICK
 06-066-240
 24 cm
 malleable



REVERDIN NEEDLE
 06-067-195 19.5 cm
 06-068-225 22.5 cm



06-069-195 19.5 cm
 06-070-225 22.5 cm



06-071-195 19.5 cm
 06-072-225 22.5 cm



06-073-195 19.5 cm
 06-074-225 22.5 cm



06-075-195 19.5 cm
 06-076-225 22.5 cm

GENERAL INSTRUMENTS

Allgemeines Instrumentarium
Instrumental general

Instrumentation générale
Strumentario generale



OCHSNER
06-077-140
14 cm



LANGE
06-078-100
10 cm



CHILDE
06-079-180
18 cm



MICHEL
06-080-120
12 cm



WACHENFELDT
06-081-125
12.5 cm



HEGENBARTH
06-082-125
12.5 cm



WACHENFELDT
06-083-125
12.5 cm



MICHEL
06-084-120
12 cm



MOD. MICHEL
06-085-120
12 cm



COLLIN
06-086-130
13 cm



RICHTER-HEATH
06-087-140
14 cm

NEEDLE HOLDERS T.C.

Nadelhalter Porta-agujas
Prote-aiguilles Porta aghi



06-088-120
12 cm
Smooth

HALSEY



06-089-105
10.5 cm
Serrated

HALSEY



06-090-130
13 cm
Serrated

CONVERSE



06-091-152
15.2 cm
Serrated

BABY-CRILE-WOOD



06-092-127
12.7 cm
Smooth

WEBSTER



06-094-145
14.5 cm
Serrated

BAUMGARTNER

NEEDLE HOLDERS T.C.

Nadelhalter Porta-agujas
Prote-aiguilles Porta aghi



06-095-152
15.2 cm
Serrated

06-096-165
16.5 cm
Serrated

06-097-210
21 cm
Serrated

06-098-165
16.5 cm
Serrated

06-099-210
21 cm
Serrated

06-100-177
17.7 cm
Serrated

06-101-230
23 cm
Serrated

06-102-255
25.5 cm
Serrated

06-103-305
30.5 cm
Serrated

DE BAKEY

DE BAKEY

DE BAKEY

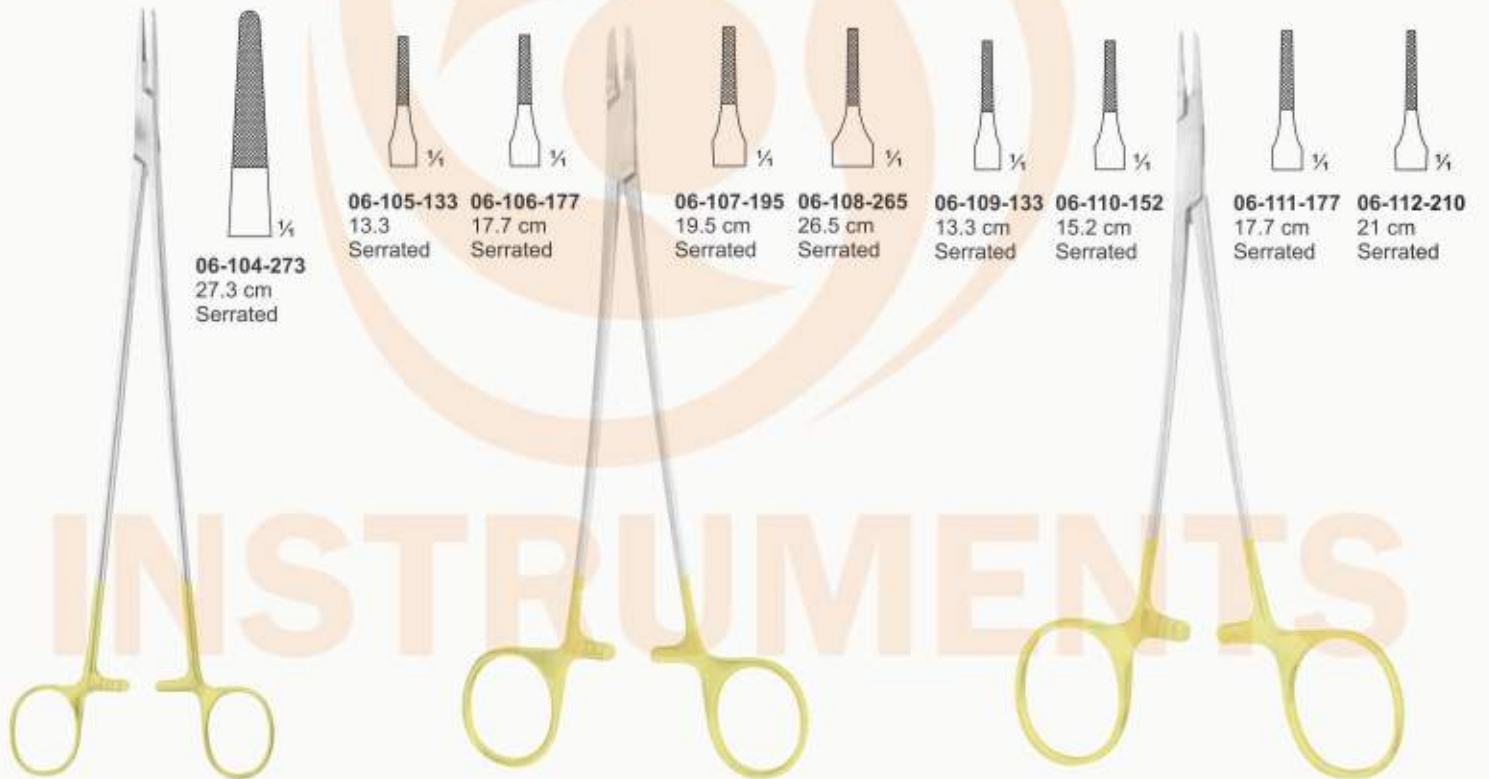

06-104-273
27.3 cm
Serrated

06-105-133
13.3 cm
Serrated

06-106-177
17.7 cm
Serrated

06-107-195
19.5 cm
Serrated

06-108-265
26.5 cm
Serrated

06-109-133
13.3 cm
Serrated

06-110-152
15.2 cm
Serrated

06-111-177
17.7 cm
Serrated

06-112-210
21 cm
Serrated

WANGENSTEEN

RYDER

RYDER

NEEDLE HOLDERS T.C.

Nadelhalter Porta-agujas
Prote-aiguilles Porta aghi



06-113-152
15.2 cm
Smooth

06-114-177
17.7 cm
Smooth

06-115-230
23 cm
Smooth

06-116-115
11.5 cm
Serrated

06-117-152
15.2 cm
06-118-152
16.0 cm
06-119-152
17.7 cm
Serrated

06-120-177
18.0 cm
06-121-177
20.3 cm
06-122-177
24.0 cm
Serrated

06-123-203
26.0 cm
06-124-203
30.0 cm
Serrated

RYDER

DERF

MAYO-HEGAR



06-125-177
17.7 cm
Serrated

06-126-260
26 cm
Serrated

06-127-152
15.2 cm
Serrated

06-128-177
17.7 cm
Serrated

SAROT

FRENCH EYE

FRENCH EYE

NEEDLE HOLDERS T.C.

Nadelhalter Porta-agujas
Prote-aguilles Porta aghi



06-129-145
14.5 cm
Serrated

06-130-177
17.7 cm
Serrated

06-131-205
20.5 cm
Serrated

06-133-130
13 cm
Serrated

06-134-203
20.3 cm
Cvd-Serrated

06-135-255
25.5 cm
Cvd-Serrated

06-132-317
31.7 cm
Serrated

CRILE-WOOD

MASING

HEANEY

GILLIES
06-136-160
16 cm



06-137-203
20.3 cm
Serrated

06-138-247
24.7 cm
Serrated

06-139-267
26.7 cm
Serrated

06-140-267
26.7 cm
Ang-Serrated

06-141-210
21 cm
Cvd-Serrated

06-142-230
23 cm
Cvd-Serrated

HEGAR

MASSON

FINOCHIETTO

STRATTE

NEEDLE HOLDERS T.C.

Nadelhalter Porta-agujas
Prote-aiguilles Porta aghi

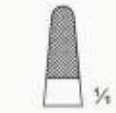

06-143-152
15.2 cm
Serrated

WIRE TWISTER

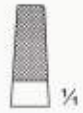

06-144-152
15.2 cm
Serrated

WIRE TWISTER



06-145-203
20.3 cm
Serrated

WIRE TWISTER



06-146-197
19.7 cm
Serrated

WIRE TWISTER

NEEDLE HOLDERS T.C.

Nadelhalter Porta-agujas
 Prote-aiguilles Porta aghi

INSTRUMENTS



06-147-140
 14 cm
 Serrated



MATHIEU



06-148-170
 17 cm
 Serrated



06-149-203
 20.3 cm
 Serrated



06-150-152
 15.2 cm
 Serrated



CRILE



06-151-177
 17.7 cm
 Serrated



TOENNIS



06-152-203
 20.3 cm
 Serrated



MATHIEU



06-153-247
 24.7 cm
 Serrated



06-154-203
 20.3 cm
 Serrated



ZWEIFEL



06-155-230
 23 cm
 Serrated



06-156-203
 20.3 cm
 Serrated



DBL-ACTION

NEEDLE HOLDERS T.C.

Nadelhalter Porta-agujas
Prote-aguilles Porta aghi



¼
06-157-170
17 cm

¼
06-158-200
20 cm

¼
06-159-240
24 cm

MATHIEU-RYDER



¼
06-160-170
17 cm

¼
06-161-200
20 cm

¼
06-162-240
24 cm

MATHIEU-RYDER



¼
06-163-200
20 cm

LUETHY-BECK



EISELSBERG-MATHEIU
06-164-185
18.5 cm



¼
06-165-165
16.5 cm

¼
06-166-150
15 cm

¼
06-167-150
15 cm

CORWIN



ARRUGA
06-168-160 16 cm Str.
06-169-160 16 cm Cvd.



BOYNTON
06-170-120
12 cm

NEEDLE HOLDERS T.C.

Nadelhalter Porta-agujas
Prote-aiguilles Porta aghi



JACOBSON

$\frac{1}{4}$
06-171-180
18 cm
Smooth

$\frac{1}{4}$
06-172-210
21 cm
Smooth

$\frac{1}{4}$
06-173-210
21 cm
Tungsten Carbide
Smooth

$\frac{1}{4}$
06-174-210
21 cm
Tungsten Carbide
Serrated-Solid



CASTROVIEJO

$\frac{1}{4}$
06-175-140
14 cm
Straight
Smooth

$\frac{1}{4}$
06-176-140
14 cm
Straight
Serrated-Solid

$\frac{1}{4}$
06-177-140
14 cm
Curved
Smooth

$\frac{1}{4}$
06-178-140
14 cm
Straight
Smooth

$\frac{1}{4}$
06-179-140
14 cm
Straight
Serrated-Solid

$\frac{1}{4}$
06-180-140
14 cm
Curved
Serrated-Solid

$\frac{1}{4}$
06-181-180
18 cm
Straight
Serrated-Solid



$\frac{1}{4}$
06-182-145
14.5 cm
Smooth

CASTROVIEJO



$\frac{1}{4}$
06-183-145
14.5 cm
Serrated

CASTROVIEJO



$\frac{1}{4}$
06-184-177
17.7 cm
Serrated

CASTROVIEJO



$\frac{1}{4}$
06-185-215
21.5 cm
Serrated

CASTROVIEJO



$\frac{1}{4}$
06-186-210
21 cm
W/Catch

JACOBSON MICRO



$\frac{1}{4}$
06-187-185
18.5 cm
Smooth

MICROSURGERY

SECTION - 07

RETRACTORS



HOOKLET & SKIN HOOKS

Wundhäkchen, Mikrohäkchen
Ganchito, Micro Ganchitos

Crochet, Micro crochetes
Divaricatore, Micro Divaricatori

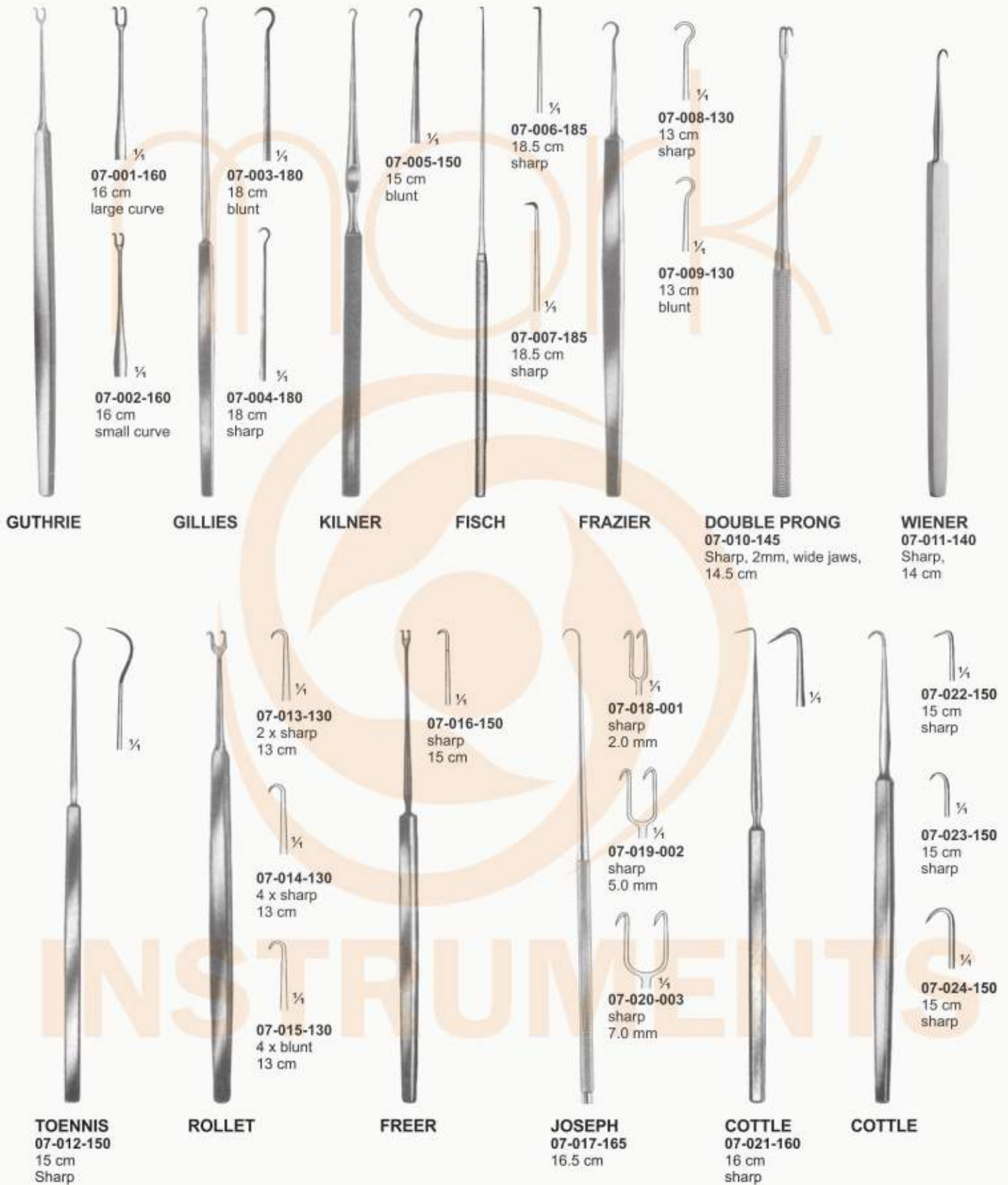

HOOKLET & SKIN HOOKS

INSTRUMENTS

Wundhäkchen, Mikrohäkchen
Ganchito, Micro Ganchitos

Crochet, Micro crochets
Divaricatore, Micro Divaricatori



LANGE
 07-025-220
 22 cm
 Fistula hook



KILNER
 07-026-100
 10 cm
 sharp
 Skin hooks



EMMET
 07-027-220
 22 cm
 Fistula hook



SIMON
 07-028-220
 22 cm
 1 x sharp
 Fistula hook



HARTMANN
 07-029-160
 16 cm
 sharp



GRAEFE



07-030-160
 16 cm
 blunt



07-031-160
 16 cm
 sharp



FOMON
 07-032-170
 17 cm
 blunt



FOMON
 07-033-160
 16 cm
 blunt
 Choana hook



COTTLE-NEIVERT
 07-034-200
 20 cm
 blunt



COTTLE
 07-035-150
 15 cm
 Sharp



COTTLE
 07-036-150
 15 cm
 blunt/Sharp



COTTLE
 07-037-150
 15 cm
 sharp/blunt



CUSHING
 07-038-190
 19 cm

HOOKLET & SKIN HOOKS

Wundhäkchen, Mikrohäkchen
Ganchito, Micro Ganchitos

Crochet, Micro crochetes
Divaricatore, Micro Divaricatori



CUSHING
07-039-190 19 cm, blunt
07-040-190 19 cm, sharp
Nerve-and
vessel hook



CUSHING
07-041-280 28 cm, blunt
07-042-280 28 cm, sharp
Nerve-and
vessel hook



CRILE
07-043-200
20 cm

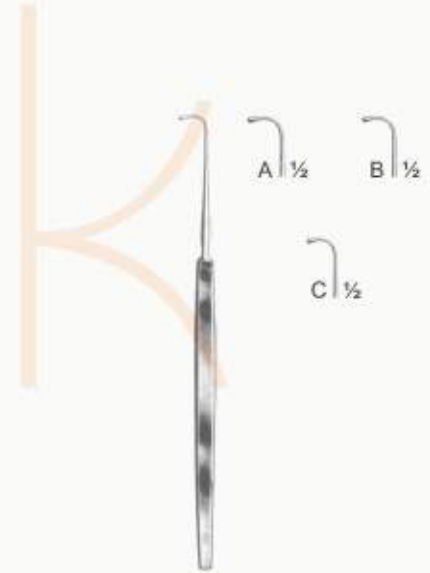

GRAEFE
07-044-130 13.0 cm - A
07-045-140 14.0 cm - B
07-046-150 15.0 cm - C



WAGENER
07-047-140 14 cm - A
07-048-140 14 cm - B
07-049-140 14 cm - C
07-050-140 14 cm - D



DAY
07-051-160 16 cm - A
07-052-160 16 cm - B



LUCAE
07-053-140 14.0 cm - A
07-054-140 14.0 cm - B
07-055-140 14.0 cm - C

INSTRUMENTS

HOOKLET RETRACTORS

INSTRUMENTS

Wundhäkchen, Wundhaken
 Ganchito, Separadores

Crochet, Ecarteurs
 Divaricatore, Divaricatori



CUSHING



CUSHING



CUSHING



CUSHING-KOCHER



DESMARRES



HOOKLET RETRACTORS

Wundhäkchen, Wundhaken
Ganchito, Separadores

Crochet, Ecarteurs
Divaricatore, Divaricatori



LANGENBECK-MINI

NEIVERT
07-082-160
16 cm

COTTLE
07-083-150
10 x 12 mm
15 cm

DESMARRES FENESTRATED

RAGNELL-DAVIS
07-088-140
8 x 4 mm
15 x 5.5 mm
14 cm



KONIG



SENN-GREEN



BABY-SENN MUELLER
07-093-160
7 x 8.5 mm
16 cm
sharp/blunt



SENN-MUELLER
07-094-160
18 x 6 mm
16 cm
sharp

RETRACTORS

INSTRUMENTS

Wundhaken Ecarteurs
 Separadores Divaricatori



SCOVILLE
 07-095-200
 7 mm
 20 cm

HOLSHER
 07-096-240
 7 mm
 24 cm

SCOVILLE
 07-097-230
 8 mm
 23 cm

STERNBERG
 07-098-120 12 cm
 07-099-140 14 cm
 07-100-160 16 cm

COLLIN-HARTMANN
 07-101-140
 38 x 28 / 32 x 21 mm 14 cm
 07-102-160
 52 x 34 / 36 x 27 mm 16 cm

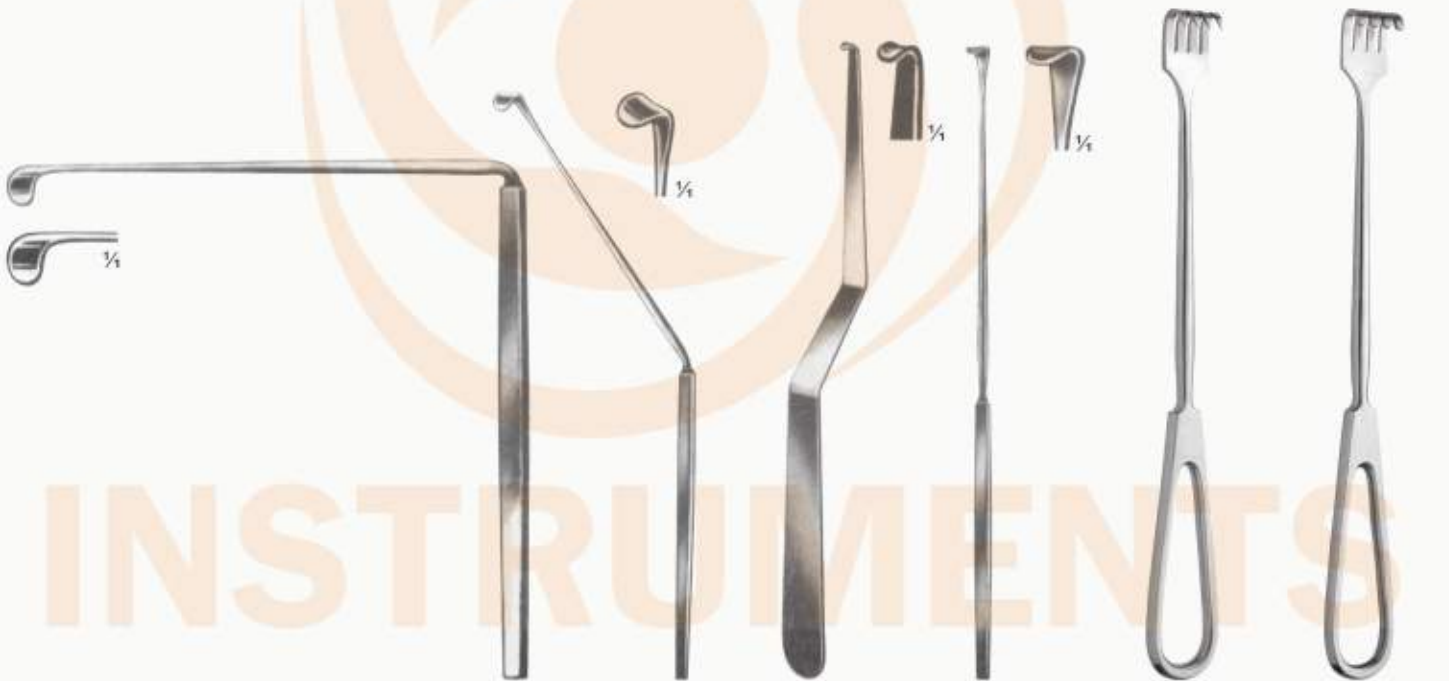

LOVE
 07-103-190
 19 cm

LOVE
 07-104-190
 19 cm

LOVE
 07-105-210
 4 mm
 21 cm

LOVE
 07-106-190
 19 cm

VOLKMAN
 07-107-220
 Sharp, 4 Prongs
 22 cm

VOLKMAN
 07-108-220
 Blunt, 4 Prongs
 22 cm

RETRACTORS

Wundhaken Ecarteurs
Separadores Divaricatori



VOLKMANN

Sharp

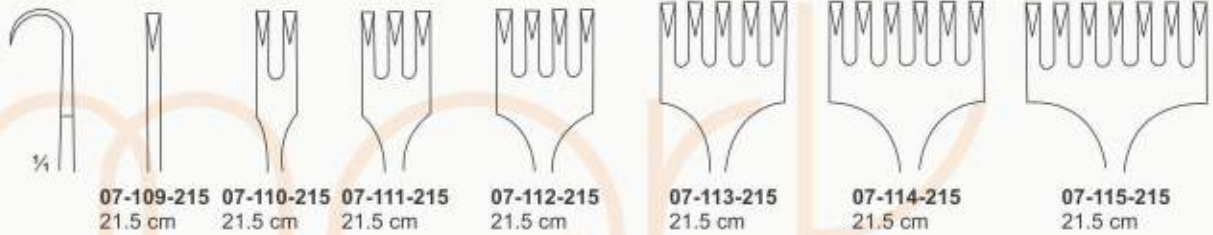

Blunt

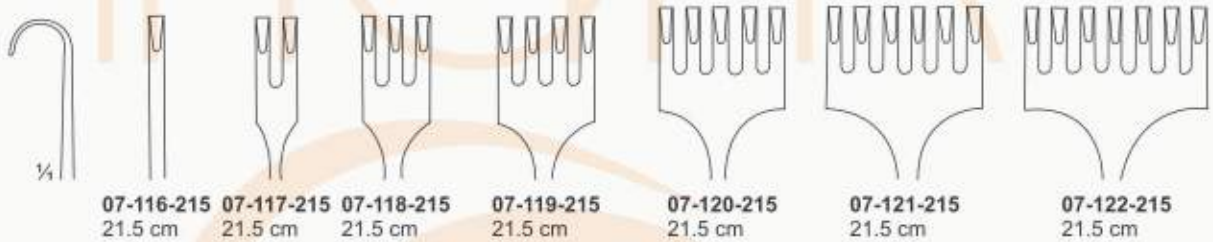

VOLKMANN

Sharp



Blunt

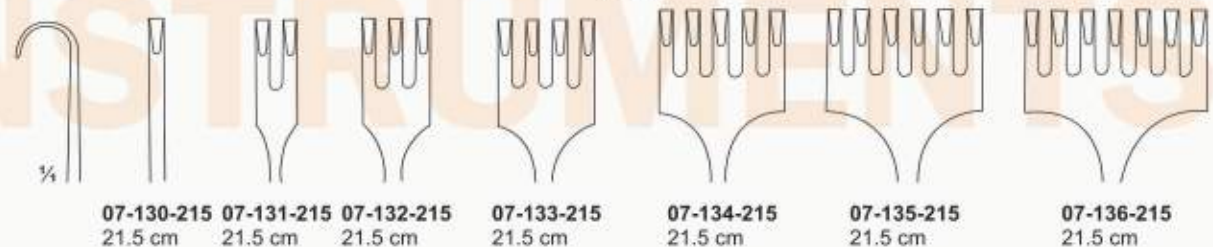

RETRACTORS

Wundhaken Ecarteurs
Separadores Divaricatori



KOCHER
Sharp

- 07-137-220 22 cm 15 x 9 mm Fig. 1
- 07-138-220 22 cm 15 x 13 mm Fig. 2
- 07-139-220 22 cm 15 x 18 mm Fig. 3
- 07-140-220 22 cm 15 x 28 mm Fig. 4
- 07-141-220 22 cm 15 x 40 mm Fig. 5



KOCHER
Blunt

- 07-142-220 22 cm 15 x 9 mm Fig. 1
- 07-143-220 22 cm 15 x 13 mm Fig. 2
- 07-144-220 22 cm 15 x 18 mm Fig. 3
- 07-145-220 22 cm 15 x 28 mm Fig. 4
- 07-146-220 22 cm 15 x 40 mm Fig. 5



Fig.2



OLLIER
blunt

- 07-147-230 23 cm 36 x 30 mm Fig.1
- 07-148-230 23 cm 36 x 60 mm Fig.2



ISRAEL
blunt

- 07-149-225 22.5 cm Blunt



ISRAEL
blunt

- 07-150-250 25 cm 40 x 40 mm Fig. 1
- 07-151-250 25 cm 46 x 50 mm Fig. 2
- 07-152-250 25 cm 52 x 60 mm Fig. 3
- 07-153-250 25 cm 70 x 70 mm Fig. 4



RETRACTORS

Wundhaken Ecarteurs
Separadores Divaricatori



MIDDELDORPF



07-154-210
14 x 7 mm
21 cm



07-155-210
20 x 22 mm
21 cm



07-156-210
26 x 30 mm
21 cm



OLLIER
07-157-185
18.5 cm



LAHEY GOITER
07-158-203 20.3 cm
right angle blade, length
1in (2.5cm). With lip.



07-159-200
20 x 7 mm
20 cm



07-160-200
30 x 7 mm
20 cm



07-161-200
30 x 11 mm
20 cm



07-162-200
30 x 15 mm
20 cm



VOLKMANN



07-163-200
30 x 20 mm
20 cm



07-164-200
44 x 10 mm
20 cm



07-165-200
44 x 15 mm
20 cm



07-166-200
45 x 20 mm
20 cm



07-167-200
50 x 20 mm
20 cm

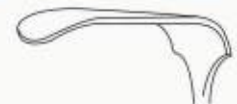

07-168-200
60 x 20 mm
20 cm

RETRACTORS

Wundhaken Ecarteurs
Separadores Divaricatori



KOCHER-LANGENBECK



07-169-215
25 x 6 mm
21.5 cm



07-170-215
35 x 8 mm
21.5 cm



07-171-215
35 x 11 mm
21.5 cm



07-172-215
35 x 15 mm
21.5 cm



07-173-215
40 x 11 mm
21.5 cm



07-174-215
55 x 11 mm
21.5 cm



07-175-215
70 x 14 mm
21.5 cm



07-176-215
80 x 12 mm
21.5 cm



07-177-215
80 x 16 mm
21.5 cm



CASPAR



07-178-210
40 x 12 mm
21 cm



07-179-210
55 x 14 mm
21 cm



KOCHER-WAGNER



07-180-280
22 x 15 mm
28 cm



07-181-280
38 x 20 mm
28 cm



07-182-280
67 x 25 mm
28 cm

RETRACTORS

Wundhaken Ecarteurs
Separadores Divaricatori



LANGENBECK

- 07-183-220 22 cm 30 x 11 mm Fig. 1
- 07-184-220 22 cm 40 x 11 mm Fig. 2
- 07-185-220 22 cm 42 x 13 mm Fig. 3



Fig. 2



Fig. 1



Fig. 3



TENDON HOOKS

- 07-186-175 17.5 cm
- 07-187-175 17.5 cm
- 12 x 6 mm Fig. 1
- 12 x 11 mm Fig. 2



Fig. 1



Fig. 2



KNEE RETRACTOR

- 07-188-225 22.5 cm
- 37 x 9 mm



MEYERDING



- 07-189-175 17.5 cm
- Saddle Shaped



- 07-190-175 17.5 cm
- Blunt



- 07-191-175 17.5 cm
- Blunt



- 07-192-175 17.5 cm
- Toothed



- 07-193-175 17.5 cm
- Toothed



- 07-194-175 17.5 cm
- Sharp

RETRACTORS

INSTRUMENTS

Wundhaken *Ecarteurs*
 Separadores *Divaricatori*



KOCHER
 07-195-190 19 x 12 mm
 19 cm
 07-196-190 21 x 14 mm
 19 cm



KOCHER
 07-197-220 40 x 10 mm
 22 cm
 07-198-220 40 x 15 mm
 22 cm
 07-199-220 40 x 20 mm
 22 cm



KOCHER
 07-200-225
 70 x 25 mm
 22.5 cm



KOCHER
 07-201-230 23 cm 35 x 18 mm
 07-202-230 23 cm 60 x 20 mm
 07-203-230 23 cm 60 x 25 mm
 07-204-230 23 cm 75 x 30 mm
 07-205-230 23 cm 75 x 40 mm



KOCHER
 07-206-250 25 cm 80 x 45 mm
 07-207-250 25 cm 80 x 55 mm
 07-208-250 25 cm 80 x 65 mm



MIDDELDORPF
 07-209-215 14 x 17 mm
 21.5 cm
 07-210-220 20 x 22 mm
 22 cm
 07-211-235 26 x 30 mm
 23.5 cm



MIDDELDORPF
 07-212-255 45 x 45 mm
 25.5 cm
 07-213-255 45 x 50 mm
 25.5 cm
 07-214-255 55 x 70 mm
 25.5 cm



GREEN

$\frac{1}{4}$
 07-215-220
 25 x 12mm
 22 cm

INSTRUMENTS

RETRACTORS

Wundhaken Ecarteurs
Separadores Divaricatori



**CHEEK-AND LIP
MOVABLE**
07-216-190
19 cm



FRITSCH
07-217-240
35 x 40 mm
24 cm



FRITSCH
07-218-240 24 cm 45 x 40 mm
07-219-240 24 cm 45 x 50 mm
07-220-240 24 cm 45 x 60 mm
07-221-240 24 cm 55 x 75 mm
07-222-240 24 cm 65 x 85 mm



KELLY
07-223-270
190 x 38 mm
27 cm
07-224-270
190 x 57 mm
27 cm



MIKULICZ
07-225-260
95 x 50 mm
26 cm



MIKULICZ
07-226-260 26 cm
95 x 35 mm
07-227-260 26 cm
120 x 50 mm
07-228-260 26 cm
150 x 50 mm



TUFFIER
07-229-230
64 x 60 mm
23 cm



DOYEN
07-230-250
50 x 85 mm
25 cm



ST. MARKS
07-231-330 33 cm
60 x 45 mm
07-232-330 33 cm
180 x 60 mm



ST. MARKS
07-233-330 33 cm
60 x 45 mm
07-234-330 33 cm
178 x 60 mm



ST. MARKS
07-235-290 29 cm
35 x 45 mm
07-236-290 29 cm
130 x 60 mm

RETRACTORS

Wundhaken Ecarteurs
Separadores Divaricatori



MEYERDING
07-237-225 22.5 cm 50 x 16 mm
07-238-225 22.5 cm 75 x 25 mm
07-239-225 22.5 cm 90 x 50 mm

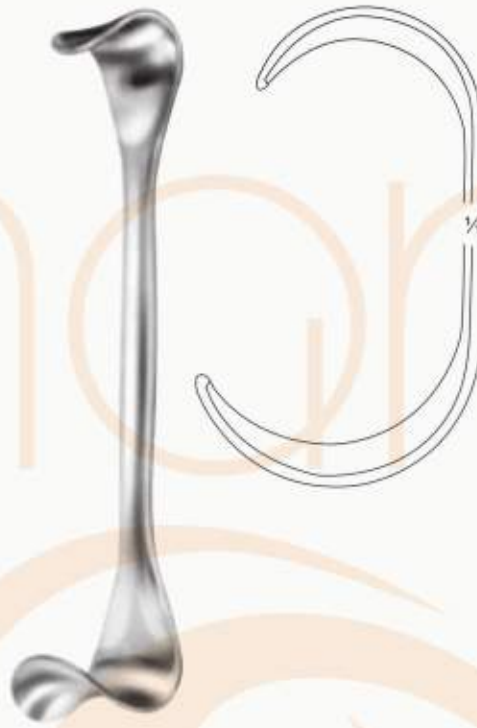

GOELET
07-240-190 19 cm
Double Ended
30 x 31, 37 x 40



KAYE-MILLARD
07-241-080
8 cm



DEAVER
07-242-300 30 cm 25 mm
07-243-300 30 cm 38 mm
07-244-300 30 cm 50 mm
07-245-300 30 cm 75 mm



HARRINGTON
07-246-320 32 cm 127 x 40 mm
07-247-320 32 cm 127 x 62 mm



RICHARDSON/KELLY



07-248-240
24 cm
25 x 31mm
Grip Handle



07-249-240
24 cm
19 x 51mm
Grip Handle



07-250-240
24 cm
38 x 51mm
Grip Handle



07-251-240
24 cm
64 x 76mm
Grip Handle



RETRACTORS

Wundhaken Ecarteurs
 Separadores Divaricatori



ALLISON
 07-252-300 30 cm
 07-253-320 32 cm
 40 mm
 54 mm



ALLISON
 07-254-260 26 cm
 137 mm



LEGUEU
 07-255-270 27 cm
 35 x 90 mm



KOCHER
 07-256-260 26 cm
 65 x 90 mm



KOERTE
 07-257-280 28 cm
 120 x 45 mm



LERICHE
 07-258-310 31 cm 45 mm
 07-259-330 33 cm 60 mm



YOUNG
 07-260-220 22 cm



YOUNG
 07-261-210 21 cm



YOUNG
 07-262-220 22 cm



YOUNG
 07-263-210 21 cm



RETRACTORS

Wundhaken Ecarteurs
 Separadores Divaricatori



MEYERDING
 07-264-235
 23.5 cm
 Medium



BRUNNER
 07-265-240
 145 x 45 mm
 24 cm



MARTIN
 07-266-250
 25 cm
 105 x 27 mm



SIMON
 07-267-220 28 cm
 07-268-270 28 cm
 115 x 22 mm
 115 x 27 mm



MOD. TUEBINGEN
 07-269-280
 28 cm
 95 x 20 mm

INSTRUMENTS

RETRACTORS

Wundhaken Ecarteurs
Separadores Divaricatori



Fig. 1 ¼

Fig. 2 ¼

Fig. 3

CORYLLOS

07-270-240 24 cm 82 x 22 mm
07-271-240 24 cm 108 x 43 mm
07-272-240 24 cm 115 x 65 mm

DAVIDSON

07-273-160 16 cm 75 x 50 mm
07-274-160 16 cm 75 x 90 mm



BRUNNER

07-275-250 25 cm 80 x 20 mm
07-276-250 25 cm 100 x 20 mm
07-277-250 25 cm 120 x 25 mm
07-278-250 25 cm 140 x 25 mm
07-279-250 25 cm 160 x 30 mm
07-280-250 25 cm 180 x 30 mm

DOYEN VAGINAL

07-281-225 22.5 cm
Blade 9.5 cm x 4.5 cm wide
07-282-250 25 cm
Blade 12.1 cm x 4.4 cm wide
07-283-234 23.4 cm
Blade 9.8 cm x 6 cm wide

RETRACTORS

Wundhaken Ecarteurs
Separadores Divaricatori



HILL FERGUSON
07-284-064
Blade 6.4 cm x 2.4 cm wide
07-285-076
Blade 7.6 cm x 3.2 cm wide
07-286-076
Blade 7.6 cm x 3.5 cm wide



MURPHY
07-287-00
3 prongs Sharp/Blunt
07-288-00
4 prongs Sharp/Blunt



VOLKMANN
Long Pattern
22.2 cm

- 07-289-222 Blunt, 2 prongs.
- 07-290-222 Blunt, 3 prongs.
- 07-291-222 Blunt, 4 prongs.
- 07-292-222 Blunt, 5 prongs.
- 07-293-222 Blunt, 6 prongs.
- 07-294-222 Sharp, 2 prongs.
- 07-295-222 Sharp, 3 prongs.
- 07-296-222 Sharp, 4 prongs.
- 07-297-222 Sharp, 5 prongs.
- 07-298-222 Sharp, 6 prongs.



07-299-235 23.5 cm
Blade 2.5 cm x 1.9 cm wide
07-300-235 23.5 cm
Blade 3.2 cm x 2.9 cm wide
07-301-254 25.4 cm
Blade 3.8 cm x 3.8 cm wide
07-302-254 25.4 cm
Blade 6.4 cm x 4.1 cm wide
07-303-235 23.5 cm
Blade 5.1 cm x 1.9 cm wide

RICHARDSON



07-304-00
13 x 235 mm
07-305-00
20 x 255 mm
07-306-00
27 x 270 mm

LAMBOTTE



RETRACTORS

Wundhaken Ecarteurs
 Separadores Divaricatori



MAYO ABDOMINAL
 07-307-000
 2.75 x 10 mm



BREWSTER
 07-308-000 Style A 0.75 x 1.50
 07-309-000 Style B 1.75 x 1.00
 07-310-000 Style C 2.00 x 1.75
 07-311-000 Style D 2.25 x 1.75
 07-312-000 Style E 2.50 x 1.75



KELLY
 07-313-230 23 cm 1.50 x 2.00
 07-314-240 24 cm 2.00 x 2.50
 07-315-250 25 cm 2.50 x 3.00
 07-316-260 26 cm 2.75 x 3.25



SIMS-KELLY
 07-317-00 2.25 x 1
 07-318-00 2.75 x 1.75
 07-319-00 3 x 1.50

INSTRUMENTS



RETRACTORS

Wundhaken Ecarteurs
 Separadores Divaricatori



DE LEE CORNER
 07-320-235 23.5 cm
 Right Blade 7 cm x 5.1 cm wide
 07-321-235 23.5 cm
 Left Blade 7 cm x 5.1 cm wide



DE LEE UNIVERSAL
 07-322-235 23.5 cm
 Blade 7 cm x 5.1 cm wide



TAUBER VAGINAL SPATULA
 07-323-235 23.5 cm
 Blade 8.9 cm x 3.5 cm wide



SAUERBRUCH
 07-324-220 22 cm 44 x 16 mm
 07-325-220 22 cm 53 x 22 mm
 07-326-220 22 cm 70 x 19 mm



HEANY
 07-327-270 27 cm 25 mm
 07-328-270 27 cm 28 mm
 07-329-270 27 cm 28 mm



RETRACTORS

Wundhaken Ecarteurs
 Separadores Divaricatori



SAUERBRUCH



07-330-225
 22.5 cm
 50 x 15 mm



07-331-225
 22.5 cm
 63 x 23 mm



07-332-225
 22.5 cm
 80 x 20 mm



07-333-250
 25 cm
 35 x 8 mm



ZENKER

07-334-265
 26.5 cm
 60 x 12 mm

07-335-275
 27.5 cm
 75 x 12 mm

07-336-285
 28.5 cm
 85 x 20 mm

07-337-305
 30.5 cm
 100 x 25 mm



SAUERBRUCH
07-338-250 25 cm
 125 x 37 mm



KADER
07-339-270 30 mm 27 cm
07-340-270 40 mm 27 cm

INSTRUMENTS

RETRACTORS

Wundhaken Ecarteurs
Separadores Divaricatori



COOLEY
07-341-250
25 cm
Right



COOLEY
07-342-250
25 cm
Right - Serrated



COOLEY
07-343-270
27 cm
Left



CRAWFORD



07-344-190
19 cm
15 X 15 mm

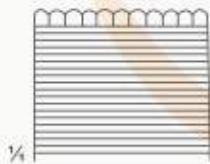

07-345-190
19 cm
15 X 23 mm



ROSS
25.5 cm



07-346-255
Fig.01



07-347-255
Fig.02



07-348-255
Fig.03



07-349-255
Fig.04



07-350-255
Fig.05



07-351-255
Fig.06



RETRACTORS

INSTRUMENTS

Wundhaken Ecarteurs
 Separadores Divaricatori



BLOUNT
 07-352-175
 17.5 cm
 42 x 4 mm



TAYLOR
 Spinal Retractors
 07-353-165 16.5 cm
 75 x 30 mm
 07-354-165 16.5 cm
 100 x 30 mm



LUER
 07-355-110 11 cm
 10 x 8 mm
 07-356-110 11 cm
 11 x 12 mm



ROSE
 07-357-130 13 cm
 12 x 10 mm
 07-358-130 13 cm
 11 x 15 mm



CRILE
 07-359-110 11 cm
 11 x 4 mm
 07-360-110 11 cm
 19 x 6 mm



BABY-ROUX
 07-361-130 13 cm
 17 x 16 mm
 07-362-130 13 cm
 18 x 22 mm



MINI-ROUX
 07-363-140
 14 cm



ROUX
 Set 3 pcs. consisting of
 07-364-140 14 cm
 24 x 20 / 30 x 28 mm
 07-365-150 15 cm
 29 x 26 / 36 x 36 mm
 07-366-170 17 cm
 33 x 29 / 38 x 43 mm

RETRACTORS

Wundhaken Ecarteurs
Separadores Divaricatori



FARABEU

Set 2 Pcs.
07-367-130 13 cm
25 x 10 / 32 x 12 mm
07-368-130 13 cm
22 x 10 / 28 x 12 mm



FARABEU

Set 2 Pcs.
07-369-150 15 cm
23 x 16 / 28 x 16 mm
07-370-150 15 cm
20 x 16 / 24 x 16 mm



PARKER

Set 2 pcs.
07-371-135 13.5 cm
22 x 15 mm
07-372-135 13.5 cm
18 x 15 mm



COLLIN

Set 2 pcs.
07-373-165 16.5 cm
21 x 14 / 32 x 16 mm
07-374-165 16.5 cm
17 x 14 / 28 x 16 mm



MATHIEU

Set 2 pcs.
07-375-200 20 cm
47 x 13 / 42 x 24 mm
07-376-200 20 cm
40 x 13 / 37 x 24 mm



US-ARMY

Set 2 pcs.
07-377-215 21.5 cm
26 x 14 / 43 x 14 mm
07-378-215 21.5 cm
22 x 14 / 39 x 14 mm



**RICHARDSON
EASTMAN**

07-379-260
26 cm
small



**RICHARDSON
EASTMAN**

07-380-280
28 cm



MATHIEU

Set of 2 Pcs.
07-381-215 21.5 cm 25 x 15 mm fig. 1
07-382-215 21.5 cm 21 x 15 mm fig. 2
07-383-215 21.5 cm 40 x 15 mm fig. 1
07-384-215 21.5 cm 46 x 15 mm fig. 2



USA

07-385-00
set of 6 pec.

RETRACTORS

Wundhaken Ecarteurs
Separadores Divaricatori



Fig.	Item	Description	Tip
A	07-386-200	20 cm	12 mm
A	07-387-200	20 cm	17 mm
A	07-388-200	20 cm	25 mm
A	07-389-250	25 cm	25 mm
A	07-390-330	33 cm	25 mm
A	07-391-330	33 cm	32 mm
A	07-392-330	33 cm	40 mm
A	07-393-330	33 cm	50 mm

MALLEABLE

RIBBON
07-394-040
20 cm
Width 4 cm

RIBBON
07-395-025
20 cm
Width 2.5 cm



TUFFIER / HABERER
malleable
07-396-200 17 x 25 mm 20 cm
07-397-280 25 x 30 mm 28 cm
07-398-300 37 x 45 mm 30 cm

REVERDIN
07-399-280
28 cm
46 x 60 mm

BLOOD SCOOP
07-400-150
15 cm

RETRACTORS

Wundhaken Ecarteurs
 Separadores Divaricatori



DEAVER
 07-401-300
 30 cm
 75 mm



DEAVER
 07-402-300
 30 cm
 50 mm



DEAVER
 07-403-300
 30 cm
 38 mm



DEAVER
 07-404-360
 36 cm
 25 mm



DEAVER
 07-405-330
 33 cm
 25 mm



DEAVER
 07-406-300
 30 cm
 25 mm



DEAVER
 07-407-230
 23 cm
 25 mm



DEAVER
 07-408-215
 21.5 cm
 22 mm



DEAVER
 07-409-180
 18 cm
 19 mm



S-SHAPED
 07-410-210
 21 cm
 12 mm

RETRACTORS

Wundhaken Ecarteurs
Separadores Divaricatori



HEISS
07-411-100 10 cm
Sharp 4:4
07-412-100 10 cm
Blunt 4:4

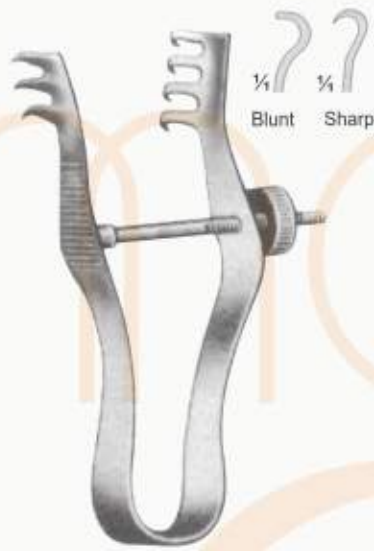

FINSEN
07-413-070 7 cm
3 x 4 teeth
sharp



FINSEN
07-414-050 5 cm
2 x 3 teeth sharp
07-415-070 7 cm
2 x 3 teeth sharp



BUCKLEY
07-416-060
6 cm



WIRE RETAINING
07-417-085 8.5 cm 3 x 3 Prong
07-418-085 8.5 cm 1 x 1 Prong Sharp



ALM
07-419-00
70 mm



JANSEN
07-420-100 10 cm
Sharp 3:3
07-421-100 10 cm
Blunt 3:3

RETRACTORS

Wundhaken Ecarteurs
 Separadores Divaricatori



WEITLANER WULLSTEIN
 07-422-130 13 cm Sharp
 07-423-130 13 cm Blunt



BECKMANN ADSON
 07-424-290
 29 cm



HOUZEL
 07-425-290



MOLLISON
 07-426-150
 15 cm

RETRACTORS

Wundhaken Ecarteurs
Separadores Divaricatori



07-427-200 20 cm
20 mm x 20 mm
Sharp 4:4
07-428-200 20 cm
19 mm x 19 mm
Blunt 4:4

ANDERSON-ADSON



07-429-310 31 cm
Sharp 4:4
19 mm x 25 mm
07-430-310 31 cm
13 mm x 25 mm
Blunt 4:4

BECKMANN



07-431-330 33 cm
47 mm x 44 mm
Blunt 7:7

BECKMANN/EATON



WEITLANER

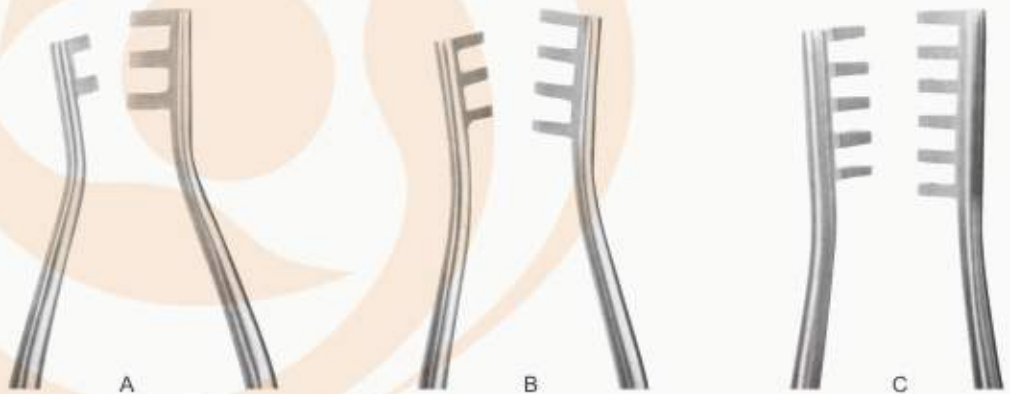

Fig.	Item	Description	Blade (Depth x width)
A	07-432-105	10.5 cm Sharp, 2:3	15 mm x 12 mm
A	07-433-105	10.5 cm Blunt, 2:3	15 mm x 12 mm
B	07-434-130	13 cm Sharp, 3:4	18.5 mm x 18.5 mm
B	07-435-130	13 cm Blunt, 3:4	18.5 mm x 18.5 mm
B	07-436-130	13 cm Sharp, 3:4	18.5 mm x 18.5 mm
B	07-437-130	13 cm Blunt, 3:4	18.5 mm x 20 mm
B	07-438-165	16.5 cm Sharp, 3:4	18.5 mm x 18.5 mm
B	07-439-165	16.5 cm Blunt, 3:4	18.5 mm x 18.5 mm
B	07-440-200	20 cm Sharp, 3:4	20 mm x 20 mm
B	07-441-200	20 cm Blunt, 3:4	20 mm x 20 mm
B	07-442-250	25 cm Sharp, 3:4	30 mm x 20 mm
B	07-443-250	25 cm Blunt, 3:4	23.5 mm x 19 mm
C	07-444-260	26 cm Sharp, 5:6	27 mm x 32 mm
C	07-445-260	26 cm Blunt, 5:6	27 mm x 32 mm

RETRACTORS

Wundhaken Ecarteurs
Separadores Divaricatori



BECKMANN/ADSON

07-446-310 31 cm
25 mm x 31 mm
Sharp 4:4
07-447-310 31 cm
25 mm x 31 mm
Blunt 4:4
07-448-310 31 cm
25 mm x 45 mm
Blunt 4:4

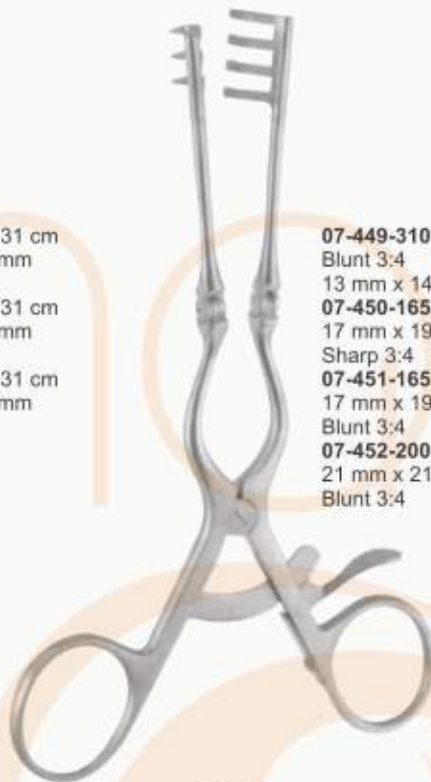

CONE

07-449-310 31 cm
Blunt 3:4
13 mm x 14.5 mm
07-450-165 16.5 cm
17 mm x 19 mm
Sharp 3:4
07-451-165 16.5 cm
17 mm x 19 mm
Blunt 3:4
07-452-200 20 cm
21 mm x 210 mm
Blunt 3:4



GELPI

07-453-090 9 cm
6 mm Sharp
07-454-110 11 cm
10 mm Sharp
07-455-140 14 cm
10 mm Sharp
07-456-190 19 cm
10 mm Sharp



GELPI PERINEAL
07-457-180
18 cm



MARKHAM/MEYERDING
07-458-180
18 cm Blade 55 x 25 mm Left
07-459-180
18 cm Blade 55 x 25 mm Right



MILLIGAN
07-460-130
18.5 mm x 20 mm
Blunt, 3:3
13 cm



RETRACTORS

Wundhaken Ecarteurs
 Separadores Divaricatori



MAYO-ADAMS
 07-461-170 17 cm
 2 x 2 teeth blunt



TUEBINGER MODELL
 07-462-160
 16 cm



PLESTER
 07-463-130
 13 cm
 2 x 2 teeth sharp



PLESTER



07-464-110
 11 cm fig. 1 Blunt



07-465-110
 11 cm fig. 2 Blunt



ADSON



ADSON-BABY
 07-466-160
 16 cm sharp
 3 x 4 teeth
 13 mm



ADSON-BABY
 07-467-160
 16 cm blunt
 3 x 4 teeth
 13 mm



07-468-320
 32 cm
 semi-sharp
 4 x 5 teeth
 26 mm

RETRACTORS

Wundhaken Ecarteurs
 Separadores Divaricatori



CLOWARD
 07-469-250 25 cm
 Complete with 5 blades
 07-470-250 25 cm
 Consisting of spreader only
 Each 1 blade



CLOWARD
 07-471-260 26 cm
 Complete with 5 blades
 07-472-260 26 cm
 Consisting of spreader only
 Each 1 blade



BLADES ONLY

- Blunt
 07-473-260 40 x 15 mm
 07-474-260 45 x 15 mm
 07-475-260 50 x 15 mm
 07-476-260 55 x 15 mm
 07-477-260 60 x 15 mm



BLADES ONLY

- Sharp
 07-478-260 40 x 15 mm
 07-479-260 45 x 15 mm
 07-480-260 50 x 15 mm
 07-481-260 55 x 15 mm
 07-482-260 60 x 15 mm



CASPAR
 07-483-160 16 cm
 Complete with 5 blades
 07-484-160 16 cm
 Consisting of spreader only
 Each 1 blade



HENLEY

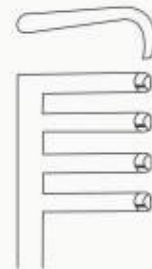

07-485-160 16 cm
 3 : 4 mm
 blunt

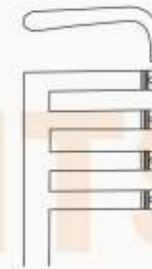

07-486-160 16 cm
 3 : 4 mm
 sharp



RETRACTORS

Wundhaken Ecarteurs
 Separadores Divaricatori



WULLSTEIN
 10.5 cm 07-487-220 07-490-220
 13.0 cm 07-488-220 07-491-220
 16.0 cm 07-489-220 07-492-220
 Sharp Blunt



TRAVERS
 07-493-220
 21 cm



RIGBY
 07-494-220 35 x 20 mm
 07-495-220 60 x 20 mm
 07-496-220 65 x 15 mm
 18 cm



MISKIMON
 07-497-220 Sharp
 07-498-220 Blunt
 22 cm

RETRACTORS

Wundhaken Ecarteurs
Separadores Divaricatori



RICARD
07-499-165 16.5 cm
spreading 160mm lateral blades 63 x 35mm
1 central blades 60 x 65mm



BALFOUR
07-500-00
70 x 85 mm Center Blade
07-501-250 25 cm 70 x 85 mm
07-502-250 25 cm 100 x 35 mm
Spread



BALFOUR/BABY
07-503-00 90 mm
07-504-00 24 x 20 mm
07-505-00 27 x 27 mm



BALFOUR/US
07-506-250 25 cm 45 x 80 mm
07-507-250 25 cm 70 x 35 mm
07-508-250 25 cm 100 x 35 mm



07-509-000
Center Blade
45 x 80 mm



BALFOUR
07-510-180 18 cm 45 x 80 mm
07-511-180 18 cm 63 x 35 mm
Spread



RETRACTORS

Wundhaken Ecarteurs
Separadores Divaricatori

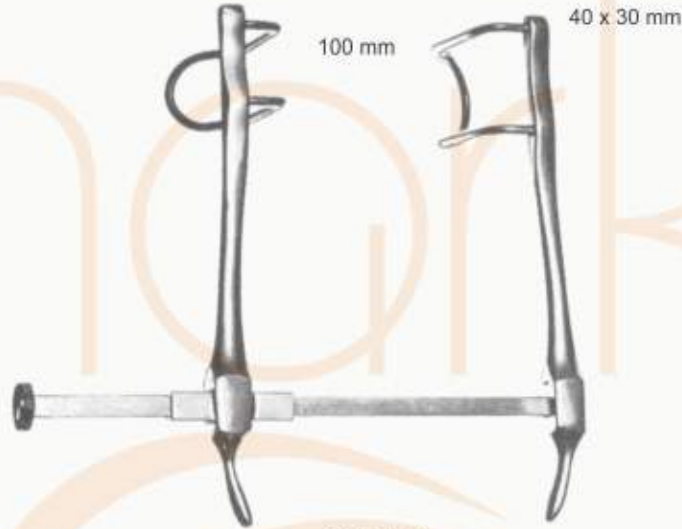

GOSSET
07-512-250



GOSSET
07-513-250



GOSSET
07-514-250



RETRACTORS

Wundhaken Ecarteurs
 Separadores Divaricatori



O'SULLIVAN/O'CONNOR
 07-515-00
 Set includes frame & 3 blades
 07-516-00
 Frame Only (not pictured)



07-517-00
 Single Retractor Blade
 110 x 70 mm



07-518-00
 Set of 2 Retractor Blade
 80 x 45 mm



BABY-COLLIN
 07-519-160 16 cm
 complete with each 2
 lateral blades

INSTRUMENTS

RETRACTORS

Wundhaken Ecarteurs
Separadores Divaricatori



COLLIN
07-520-180 18 cm
complete with 2 lateral
blades

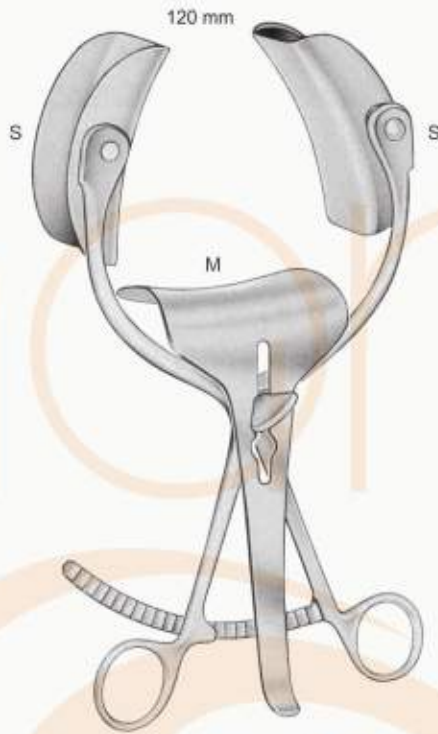

COLLIN

	S	M
07-521-00	38 x 62 mm	55 x 55 mm
07-522-00	38 x 80 mm	55 x 65 mm
07-523-00	38 x 100 mm	55 x 75 mm



LEGUEU
07-524-210
17 cm



RICARD
07-525-280 28 cm
complete with 2 lateral
blades and central blade
70 mm x 90 mm



DOYEN

07-526-280	28 cm 48 mm x 90 mm
07-527-280	28 cm 48 mm x 105 mm
07-528-280	28 cm 48 mm x 120 mm
07-529-280	28 cm 48 mm x 135 mm



ROCHARD

07-530-310	31 cm 48 mm x 90 mm
07-531-310	31 cm 48 mm x 105 mm
07-532-310	31 cm 48 mm x 120 mm
07-533-310	31 cm 48 mm x 135 mm
07-534-310	31 cm 48 mm x 155 mm

RETRACTORS

Wundhaken Ecarteurs
Separadores Divaricatori

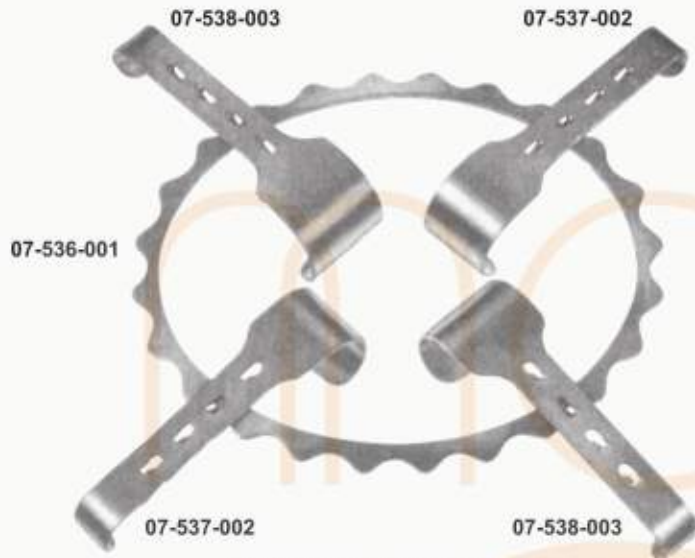

ABDOMINAL RETRACTORS
for new-born and children

DENIS-BROWNE

07-535-000
complete

07-536-001 Frame 190 x 160 mm
07-537-002 2 blades only 40 x 30 mm
07-538-003 2 blades only 40 x 40 mm

07-539-004
Blades only 20 x 30 mm

07-540-005
Blades only 20 x 40 mm



ABDOMINAL RETRACTORS
well suitable for gynaecologists

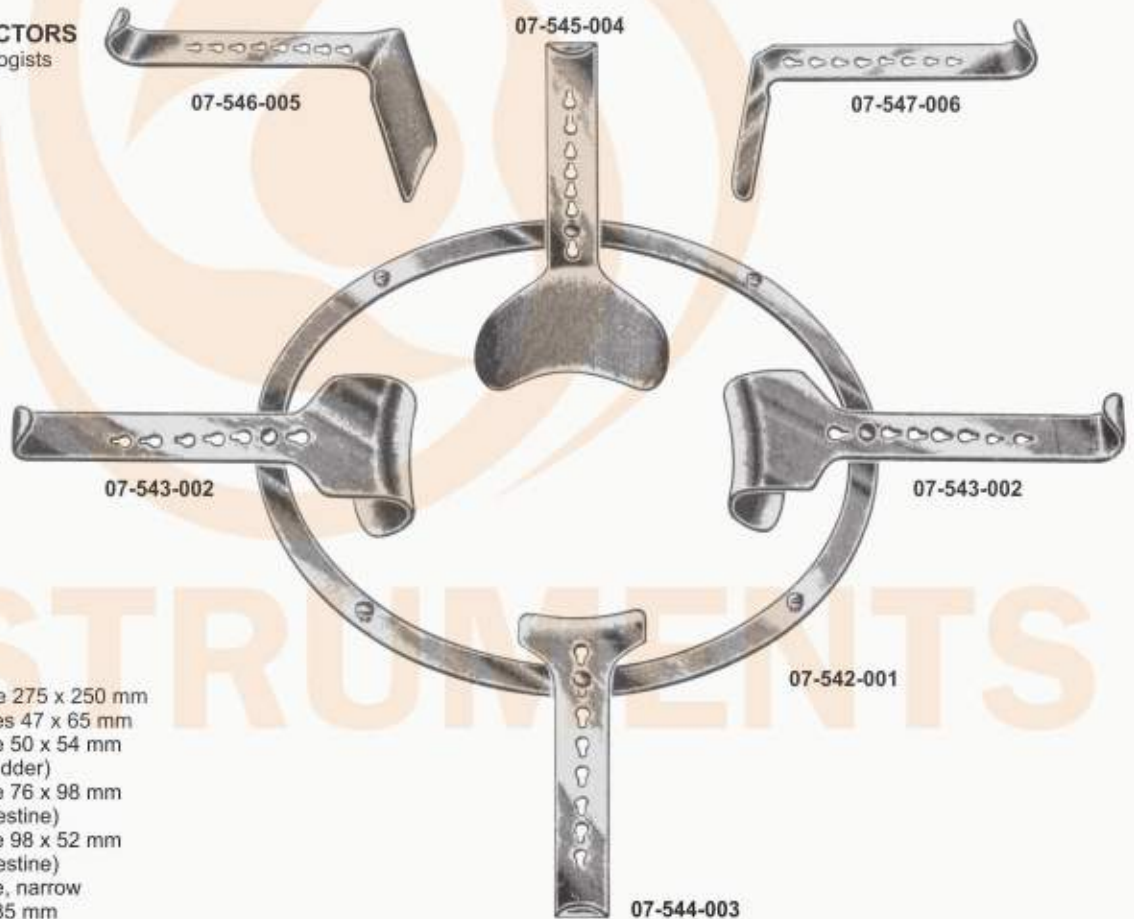

semm

07-541-000

Consisting of:

- 07-542-001 1 frame 275 x 250 mm
- 07-543-002 2 blades 47 x 65 mm
- 07-544-003 1 blade 50 x 54 mm
(for bladder)
- 07-545-004 1 blade 76 x 98 mm
(for intestine)
- 07-546-005 1 blade 98 x 52 mm
(for intestine)
- 07-547-006 1 blade, narrow
105 x 35 mm

RETRACTORS

Wundhaken Ecarteurs
Separadores Divaricatori

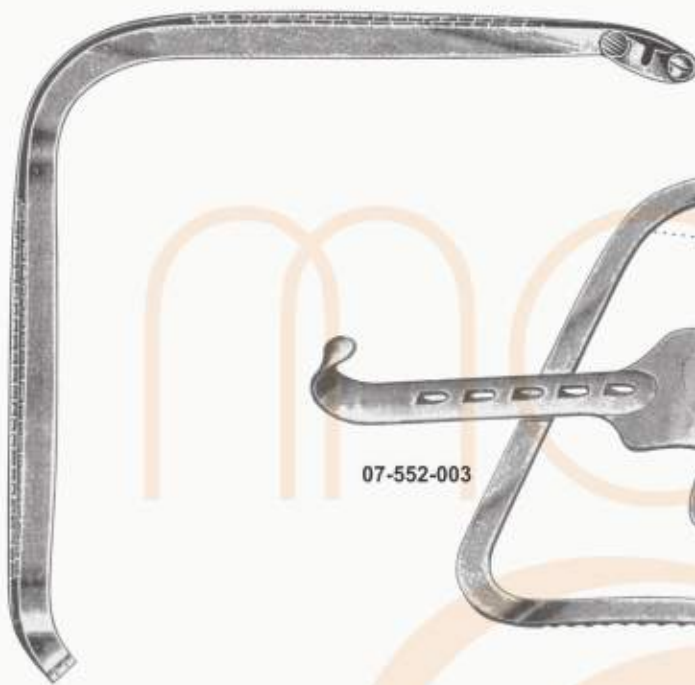

KIRSCHNER
07-548-001
with folding frame &
2 blades of each 07-552-003 &
07-553-004

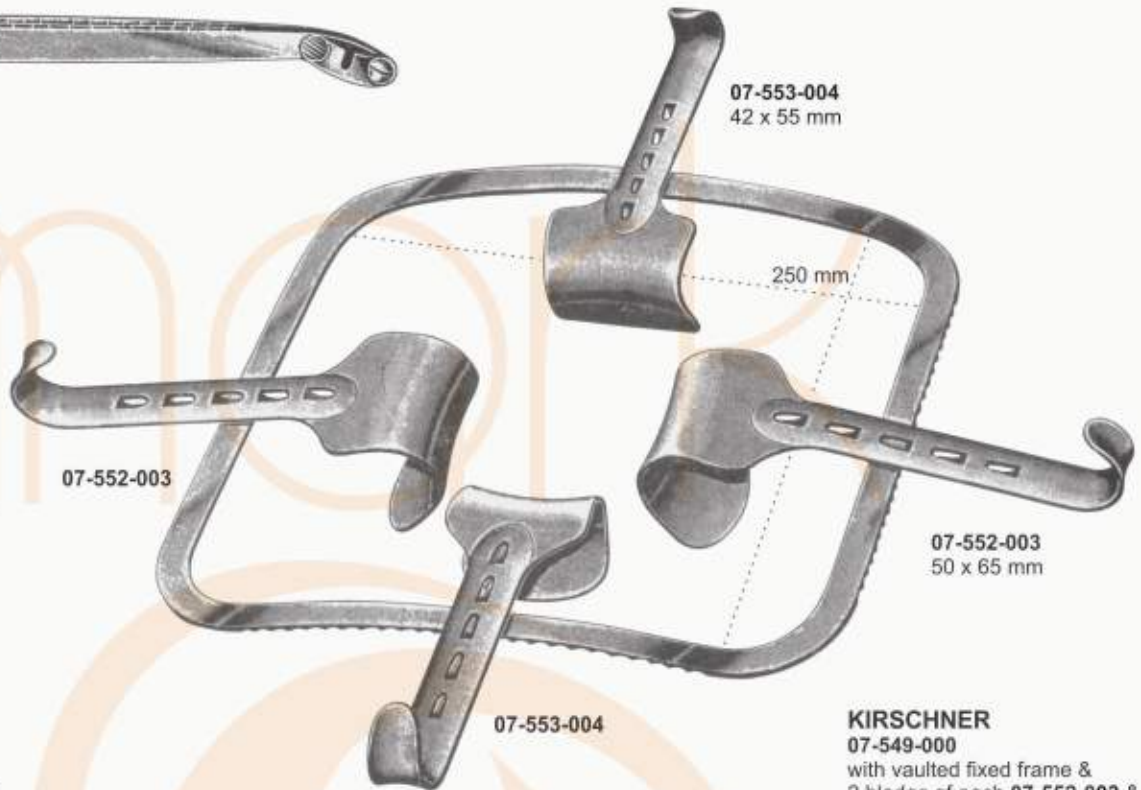

07-552-003

07-553-004
42 x 55 mm

250 mm

07-552-003
50 x 65 mm

07-553-004

KIRSCHNER
07-549-000
with vaulted fixed frame &
2 blades of each 07-552-003 &
07-553-004
07-550-001
300 x 380 mm
Frame only, over-sized
07-551-002
320 x 300 mm
Frame only

Additional valves for corpulent persons



KIRCHNER
07-554-001
65 x 80 mm



KIRCHNER-BALFOUR
07-555-001
80 x 80 mm



KIRCHNER
07-556-001 90 x 65 mm
07-557-002 90 x 90 mm
07-558-003 80 x 57 mm



KIRCHNER
07-559-001 105 x 40 mm
07-560-002 090 x 55 mm
07-561-003 120 x 55 mm

INSTRUMENTS

SECTION - 08

GENERAL INSTRUMENTS



PROBES & DIRECTORS

Sonden Sondas y estiletes
Sondes et stylets Specilli e sonde



DOYEN
08-001-145
14.5 cm

NELATON
08-002-160
16 cm

LOCKHART-MUMMERY
08-003-200
20 cm

PROBE
with Eye

08-004-115
11.5 cm
Straight, 2 mm
08-005-130
13 cm
Straight, 2 mm
08-006-145
14.5 cm
Straight, 2 mm
08-007-160
16 cm
Straight, 2 mm

PROBE
With Eye /
Double Ended

08-008-160
16 cm, 2 mm

**LARRY-RECTAL /
GROOVED DIRECTOR**
08-009-150
15 cm



BOWMAN LACRIMAL PROBES

08-010-001 - 08-015-006

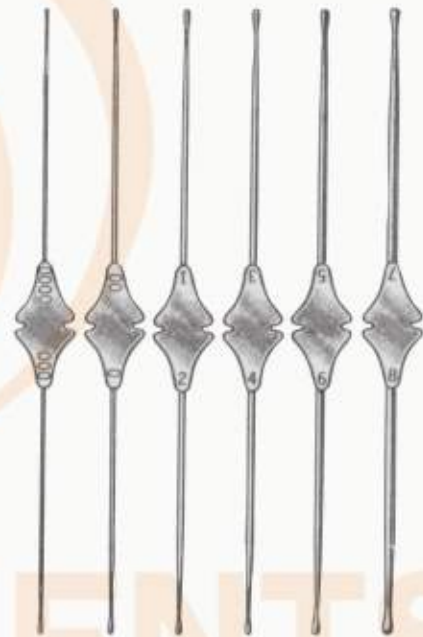

WILLIAM LACRIMAL PROBES

08-016-001 - 08-021-006

08-010-001 Bowman Probe, 000-0000, Double Ended, Sterling Silver
08-011-002 Bowman Probe, 00-0, Double Ended, Sterling Silver
08-012-003 Bowman Probe, 1-2, Double Ended, Sterling Silver
08-013-004 Bowman Probe, 3-4, Double Ended, Sterling Silver
08-014-005 Bowman Probe, 5-6, Double Ended, Sterling Silver
08-015-006 Bowman Probe, 7-8, Double Ended, Sterling Silver

08-016-001 William Probe, 000-0000, Double Ended, Sterling Silver
08-017-002 William Probe, 00-0, Double Ended, Sterling Silver
08-018-003 William Probe, 1-2, Double Ended, Sterling Silver
08-019-004 William Probe, 3-4, Double Ended, Sterling Silver
08-020-005 William Probe, 5-6, Double Ended, Sterling Silver
08-021-006 William Probe, 7-8, Double Ended, Sterling Silver

GENERAL INSTRUMENTS

Allgemeines Instrumentarium
Instrumental general

Instrumentation générale
Strumentario generale



**FARRELL
APPLICATOR**
08-022-065 - 65 cm
08-023-060 - 60 cm
08-024-090 - 90 cm



**BUCK
APPLICATOR**
08-025-075 - 75 cm



**BUCK
APPLICATOR**
08-026-050 - 50 cm



VOLLMAR
08-027-115
11.5 cm



MARTIN APPLICATOR
08-028-120 12 cm
08-029-140 14 cm
08-030-160 16 cm



STACKE
08-031-100
10 cm



**SPLINTER LIBERATOT
TROCAR POINT**
08-032-130
13 cm

NAIL NIPPERS

Nagelzangen
 Nail Nippers

pincès à ongles
 Nail Tronchesi



08-033-110
 11 cm

CUTICLE NIPPER



08-034-140 08-035-140
 14 cm 14 cm
 Straight Concave

NAIL CUTTER



08-036-140
 14 cm
 Angled /
 Concave

NAIL CUTTER



08-037-00
 Hollow Blades On
 Both Sides
 08-038-00
 Blade Flat / Hollow

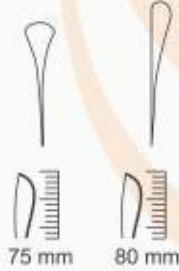

75 mm 80 mm



NAIL CUTTER
 08-039-130
 13 cm
 Straight



NAIL CUTTER
 08-040-155
 15.25 cm
 Barrel Spring
 Concave



NAIL CUTTER



08-041-130
 13 cm
 Barrel Spring
 Concave

SECTION - 09

ORTHOPAEDICS





1/2

ST. THOMAS
 09-001-160
 16 cm
 Pointed



1/2

ST. THOMAS
 09-002-160
 16 cm
 Rounded



1/2

ROBINSON'S
 09-003-170
 17 cm



1/2

WILLIGER
 09-004-160
 16 cm



1/2

LANE
 09-005-160
 16 cm
 Serrated



1/2

LANE
 09-006-270
 27 cm



1/2

TRETHOWAN'S
 09-007-220
 22 cm



1/2

BRISTOW'S
 09-008-240
 24 cm



1/2

SEDILLOT
 09-009-210
 21 cm



1/2

LANGENBECK
 09-010-180
 18 cm



LANGENBECK
 09-011-190
 19 cm



HOHMANN
 09-012-150
 15 cm



HOHMANN
 09-013-154
 15.4 cm
 Short tip

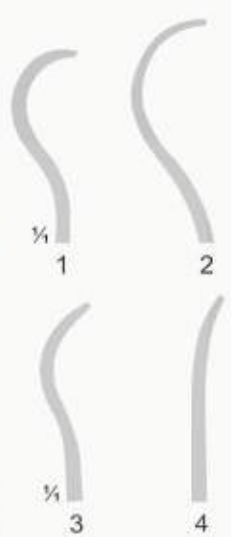

PERIOSTEAL ELEVATOR

17.5 cm
 For Metacarpals Small

09-014-175 6 mm width
 For Metacarpals Medium

09-015-175 10 mm width
 Light Curve, Rounded End,

09-016-175 5 mm width
 Contra Angled Curve

09-017-175 4.5 mm width



BUCK GRAMCKO
 09-018-180 18 cm
 Small, width 6 mm
 short, narrow tip



BUCK GRAMCKO
 09-019-180 18 cm
 Small, width 8 mm
 short, narrow tip



HOHMANN
 09-020-200 20 cm
 Width 8 mm
 short, narrow tip



HOHMANN
 09-021-200 20 cm
 Width 18 mm short, narrow tip
 09-022-200 20 cm
 Width 18 mm long, narrow tip



HOHMANN
 09-023-160 16 cm
 For Small Fragments
 Board Shank



HOHMANN
 09-024-180 18 cm
 Width 43 mm
 narrow tip
 09-025-180 18 cm
 Width 70 mm
 narrow tip



HOHMANN
 09-026-180 18 cm
 Width 43 mm
 long shank, angled



HOHMANN
 09-027-160 16 cm
 width 22 mm wide tip



HOHMANN
 09-028-160 16 cm
 long wire tip for Hip
 Surgery, width 24 mm



**LANGE-
 HOHMANN**
 09-029-240
 24 cm



BENNETT
 09-030-260
 26 cm, 65 mm



BLOUNT
 09-031-270
 27 cm, Blunt



AUFRANC
 09-032-290
 29 cm



AUFRANC
 09-033-290
 29 cm



AUFRANC
 09-034-290
 29 cm



09-036-190
19 cm, 13 mm
09-037-200
20 cm, 20 mm
09-038-230
23 cm, 25 mm
09-039-250
25 cm, 31 mm

¼

CHANDLER
09-035-250
25 cm



½

HOENN PERIOSTEAL
09-040-165
16.5 cm



½

KEY PERIOSTEAL
09-041-180
18 cm, Tip ½"



½

KEY
(Fig. A)

09-042-190 19 cm 3 mm
09-043-190 19 cm 6 mm
09-044-190 19 cm 9 mm
09-045-190 19 cm 12 mm
09-046-190 19 cm 15 mm
09-047-190 19 cm 19 mm
09-048-190 19 cm 25 mm



¼

COBB
Elevators
09-049-234
23.4 cm
Hex Handle



SEMB
09-050-195 - 09-054-195
255 mm
22 ¾ cm



09-050-195
195 mm
19.5 cm



09-051-195



09-052-195



09-053-195



09-054-195



09-055-200 20 cm
 Medium straight
 blade round edge,
 width 14 mm



09-056-200 20 cm
 Medium curved
 blade round edge,
 width 14 mm



09-057-180 18 cm
 Small curved
 blade round edge,
 width 6 mm



09-058-180 18 cm
 Small curved
 blade straight edge,
 width 6 mm



09-059-180
 18 cm
 Extra small
 curved blade
 round edge,
 width 3 mm



09-060-200 20 cm
 large straight blade
 round edge,
 width 20 mm



Straight Edge, 14 mm
09-061-185
 Straight 18.5 cm
09-062-185
 Curved 18.5 cm



LAMBOTTE 21 cm
09-063-210 1.0 cm
09-064-210 1.5 cm
09-065-210 2.0 cm



FARABEUF
09-066-150
 15 cm



FARABEUF
09-067-150
 15 cm



MANNERFELT modif
09-068-160 5 mm
09-069-160 6 mm
09-070-160 7 mm
 16 cm



ALEXANDER
09-071-200
20 cm



MATSON
09-072-220
22 cm



JOSEPH
09-073-170
17 cm
with plastic handle

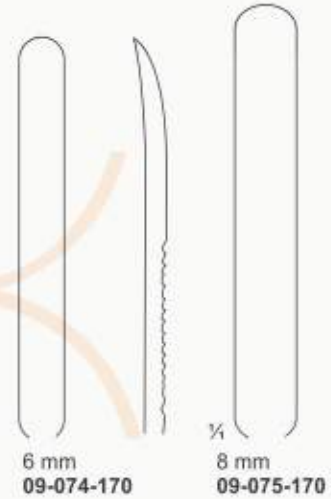

09-078-170
Right Curved
For Children

09-079-170
Right Curved
For Adults



09-080-170
Left Curved
For Children

09-081-170
Left Curved
For Adults

Rib Raspatories
with hollow handle

DOYEN
09-076-170
for children
09-077-170
for adult
17 cm, 180 mm



ADSON
09-082-170
17 cm

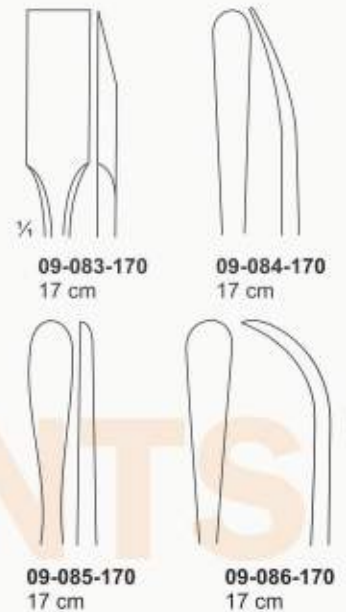

09-083-170
17 cm

09-084-170
17 cm

09-085-170
17 cm

09-086-170
17 cm



GALLAHER
09-087-177
17.7 cm
180 mm

PUTTI
09-088-280
28 cm

PUTTI
09-089-300
30 cm

BONE TAMPS
09-090-154
15.4 cm
Tip Dia. 10 mm.

09-091-240
24 cm
240 mm



FOMAN RASP
09-092-210
21 cm



MILLER-COLBURN
09-093-180
18 cm

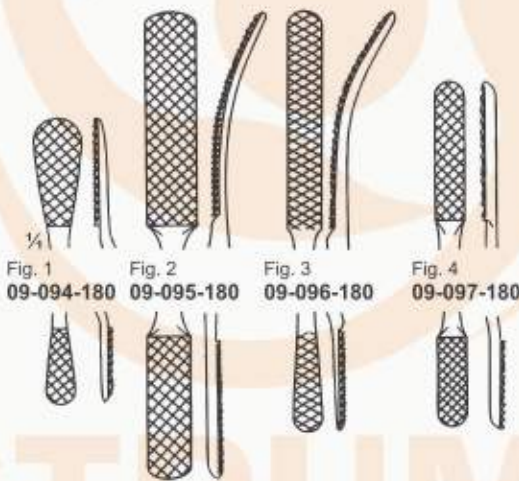

MILLER FILE
09-098-190
19 cm



MILLER FILE
09-099-190
19 cm



BRUNS
1/2

○ 09-100-170 17 cm 000	○ 09-101-170 17 cm 00
○ 09-102-170 17 cm 0	○ 09-103-170 17 cm 1
○ 09-104-170 17 cm 2	○ 09-105-170 17 cm 3
○ 09-106-170 17 cm 4	○ 09-107-170 17 cm 5
○ 09-108-170 17 cm 6	



VOLKMANN
1/2

○ 09-109-170 17 cm 0000	○ 09-110-170 17 cm 000	○ 09-111-170 17 cm 00
○ 09-112-170 17 cm 0	○ 09-113-170 17 cm 1	○ 09-114-170 17 cm 2
○ 09-115-170 17 cm 3	○ 09-116-170 17 cm 4	○ 09-117-170 17 cm 5
		○ 09-118-170 17 cm 6



SIMON
24 cm
1/2

○ 1/4
Fig.1
09-119-240

○
Fig.2
09-120-240

○
Fig.3
09-121-240

○
Fig.4
09-122-240

○
Fig.5
09-123-240

○
Fig.6
09-124-240



HIBBS-SPRRATT / ANGLED
1/3

○ 09-125-225 22.5 cm 000	○ 09-126-225 22.5 cm 00
○ 09-127-225 22.5 cm 0	○ 09-128-225 22.5 cm 1
○ 09-129-225 22.5 cm 2	○ 09-130-225 22.5 cm 3
○ 09-131-225 22.5 cm 4	○ 09-132-225 22.5 cm 5
○ 09-133-225 22.5 cm 6	



HIBBS-SPRRATT / STRAIGHT
1/3

○ 09-134-225 22.5 cm 000	○ 09-135-225 22.5 cm 00
○ 09-136-225 22.5 cm 0	○ 09-137-225 22.5 cm 1
○ 09-138-225 22.5 cm 2	○ 09-139-225 22.5 cm 3
○ 09-140-225 22.5 cm 4	○ 09-141-225 22.5 cm 5
○ 09-142-225 22.5 cm 6	



UFFENORDE LEFT
09-143-175
17.5 cm
1/4



UFFENORDE RIGHT
09-144-175
17.5 cm
1/4

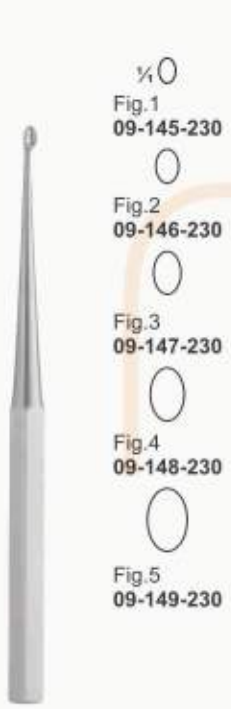

BRUNS
23cm

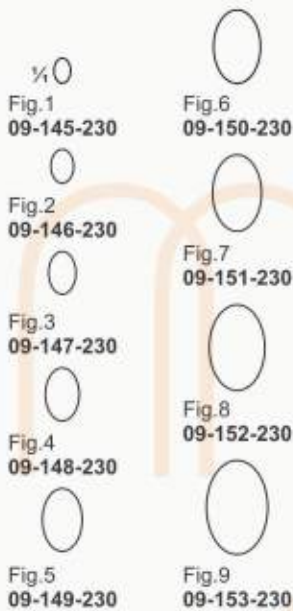

SPRATT

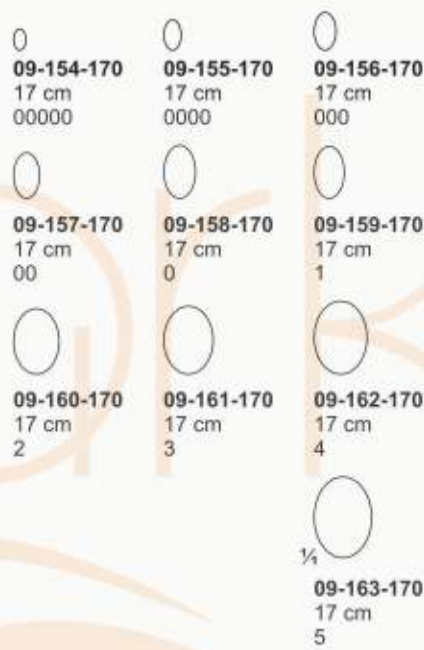

09-164-250
25 cm



FIBER HANDLE
27 cm



SCOVILLE
25 cm



LUCAS
double-ended
09-176-180
18 cm

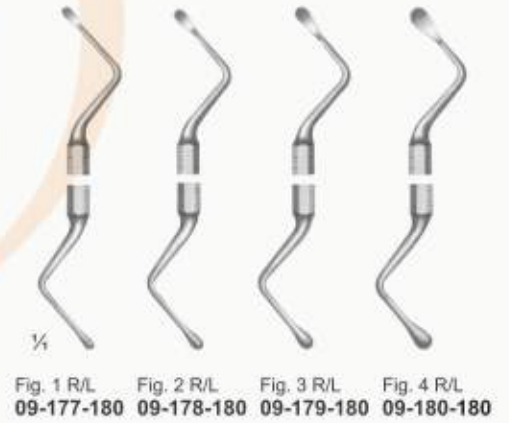

INSTRUMENTS



WILLIGER
09-181-133
13.25 cm
Double Ended
00/0



VOLKMANN



09-182-130
13 cm
Double Ended
6.2 mm & 6.7 mm



09-183-160
16 cm
Double Ended
7 mm & 9 mm



09-184-200
20 cm
Double Ended
9.1 mm & 11.1 mm



VOLKMANN
09-185-133
15 cm



VOLKMANN
09-186-133
20 cm



VOLKMANN
09-187-133
25 cm



MARTINI
09-188-140
14 cm



JANSEN
09-189-160
16 cm



JANSEN
09-190-150
15 cm



09-191-160
16 cm



KERPEL
09-192-150
09-193-150
15 cm



KERPEL
09-194-150
09-195-150
15 cm



plane (nylon)
convex (steel)
plastic handle
Head 30mm Ø
Weight 675 Gr.

1/4

MALLET
09-196-265
26.5 cm



plastic handle
Head 42 / 30mm Ø
Weight 530 Gr.

1/4

MALLET
09-197-260
26 cm



plastic handle
Head 30mm Ø
Weight 480 Gr.

1/4

MALLET
09-198-240
24 cm



Plastic Handle
Head 30mm Ø
Weight 510 Gr.

1/4

MALLET
09-199-260
26 cm



Spare Facing (pair)
09-201-00
Plastic

1/4

MALLET
09-200-240
24 cm



made of plastic
Head 30mm Ø
Weight 125 Gr.

1/4

MALLET
09-202-220
22 cm



made of plastic
with lead filling
Head 42mm Ø
Weight 400 Gr.
Head 42mm Ø
Weight 250 Gr.

1/4

MALLET
09-203-260
26 cm



made of plastic
with lead filling
Head 42mm Ø
Weight 400 Gr.

1/4

MALLET
09-204-260
26 cm



1/2
**ORTHO / WITH
 PLASTIC CAPS**
 09-205-180
 18 cm
 25 mm Dia.
 5OZ (140g)



1/2
HAJEK
 09-206-223
 22.25 cm
 27 mm Dia.
 5OZ (140g)



1/2
BERGMANN
 09-207-240
 24 cm
 10 1/4OZ (300g)



1/2
COTTLE
 09-208-190
 19 cm
 8 1/2OZ (240g)



1/2
COLLIN
 09-209-230
 23 cm
 33 mm Dia.
 7 3/4OZ (220g)



1/4
09-211-155
 Head 26 mm Ø
 Weight 300 Gr.
09-212-155
 Head 28 mm Ø
 Weight 340 Gr.
09-213-155
 Head 30 mm Ø
 Weight 400 Gr.

1/2
WILLIGER
 09-210-155
 15.5 cm



09-215-205
Head 25 mm Ø
Weight 120 Gr.
09-216-205
Head 30 mm Ø
Weight 180 Gr.
09-217-205
Head 35 mm Ø
Weight 260 Gr.

1/2
DOYEN
09-214-205
20.5 cm

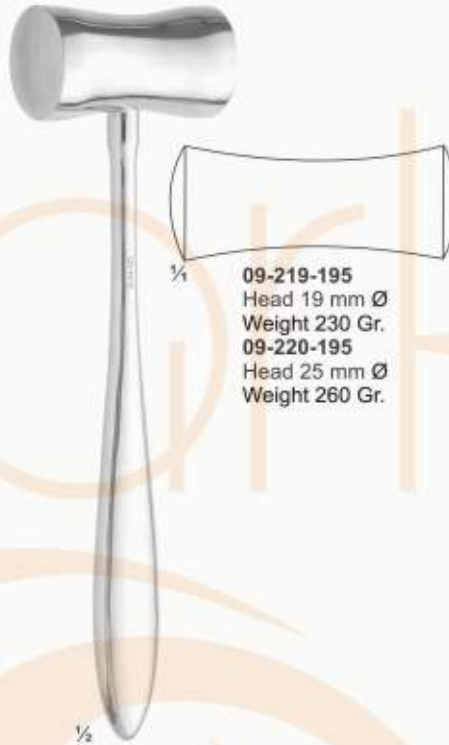

09-219-195
Head 19 mm Ø
Weight 230 Gr.
09-220-195
Head 25 mm Ø
Weight 260 Gr.

1/2
LUCAE
09-218-195
19.5 cm



1/2
WILLIGER
09-221-165
16.5 cm
Head 20 mm ø
weight 140 Gr.



1/2
PARTSCH
09-222-190
19 cm
Head 22mm Ø
Lead Filled



Spare Facings
09-225-190

1/2
MEAD
09-223-190
19 cm
09-224-190
with interchangeable
Plastic dicks
Head 27 mm Ø
Weight 320 Gr.



HEATH
09-226-165
16 cm
Head 3.5 cm Ø
weight 510.27 Gr.
09-227-165
Head 4.5 cm Ø
weight 793 Gr.



ORTHOPAEDICS

Orthopädie
Ortopedia

Orthopédie
Ortopedia



3/4
2 mm
09-228-135
13.5 cm

3 mm
09-229-135
13.5 cm

4 mm
09-230-135
13.5 cm

5 mm
09-231-135
13.5 cm

6 mm
09-232-135
13.5 cm

2 mm
09-233-170
17.0 cm

3 mm
09-234-170
17.0 cm

4 mm
09-235-170
17.0 cm

5 mm
09-236-170
17.0 cm

6 mm
09-237-170
17.0 cm



3/4
2 mm
09-238-135
13.5 cm

3 mm
09-239-135
13.5 cm

4 mm
09-240-135
13.5 cm

5 mm
09-241-135
13.5 cm

6 mm
09-242-135
13.5 cm

2 mm
09-243-170
17 cm

3 mm
09-244-170
17 cm

4 mm
09-245-170
17 cm

5 mm
09-246-170
17 cm

6 mm
09-247-170
17 cm



3/4
4 mm
09-248-170

6 mm
09-249-170

8 mm
09-250-170

10 mm
09-251-170

12 mm
09-252-170

14 mm
09-253-170



3/4
4 mm
09-254-180

6 mm
09-255-180

8 mm
09-256-180

10 mm
09-257-180

12 mm
09-258-180

14 mm
09-259-180



ORTHOPAEDICS

Orthopädie
Ortopedia

Orthopédie
Ortopedia

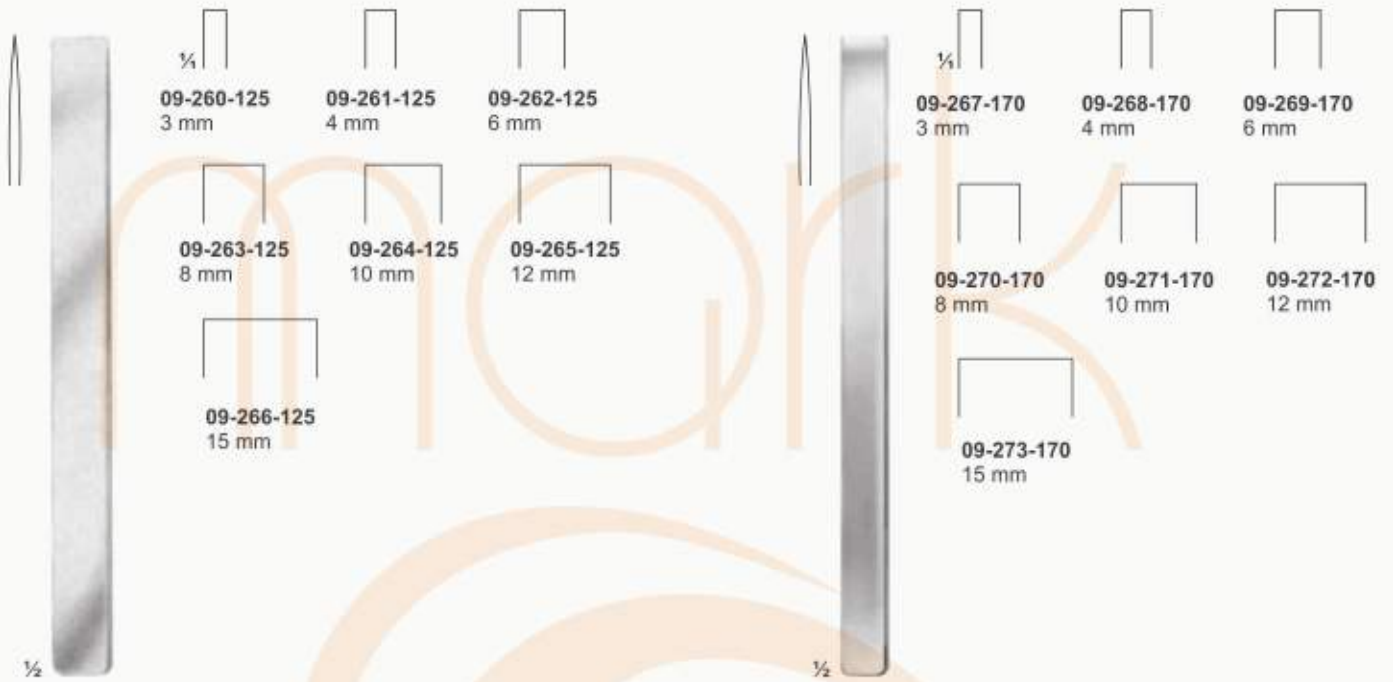

MINI-LAMBOTTE
12.5 cm

MINI LAMBOTTE
17 cm



LAMBOTTE
24 cm

LAMBOTTE
23 cm

- 09-281-230 15 mm
- 09-282-230 20 mm
- 09-283-230 25 mm
- 09-284-230 30 mm
- 09-285-230 38 mm
- 09-286-230 44 mm
- 09-287-230 50 mm



1/2

LEXER FLAT

- 09-288-220 1.0 cm
- 09-289-220 1.5 cm
- 09-290-220 2.0 cm
- 09-291-220 2.5 cm
- 22 cm Tip size



1/2

LEXER HOLLOW

- 09-292-220 1.0 cm
- 09-293-220 1.5 cm
- 09-294-220 2.0 cm
- 09-295-220 2.5 cm
- 22 cm Tip size



1/2

MINI LEXER

- 09-296-180
- 18 cm



1/2

MINI LEXER

- 09-297-180
- 18 cm
- Hollow



1/2

LEXER Straight

- 09-298-250 0.5 cm
- 09-299-250 1.0 cm
- 09-300-250 1.5 cm
- 25 cm Tip size



1/2

LEXER Curved

- 09-301-250 0.5 cm
- 09-302-250 1.0 cm
- 09-303-250 1.5 cm
- 25 cm Tip size



Spongiosa chisels

ZIELKE

- 09-304-250 5 mm
- 09-305-250 10 mm
- 09-306-250 15 mm
- gebogen/curved
- 250 mm,
- 25 cm



1/2
Gouges for scoliosis operations

ZIELKE

- 09-307-250 5.5 mm
- 09-308-250 9.0 mm
- 230 mm,
- 23 cm



- 09-309-200 Straight 0.6 cm
- 09-310-200 Straight 0.9 cm
- 09-311-200 Straight 1.2 cm
- 09-312-200 Straight 1.5 cm
- 09-313-200 Straight 2.0 cm
- 09-314-200 Straight 2.5 cm
- 09-315-200 Straight 3.0 cm
- 09-316-200 Curved 0.6 cm
- 09-317-200 Curved 0.9 cm
- 09-318-200 Curved 1.2 cm
- 09-319-200 Curved 1.5 cm
- 09-320-200 Curved 2.0 cm
- 09-321-200 Curved 2.5 cm
- 09-322-200 Curved 3.0 cm

SMITH PETERSON
20 cm



- 09-323-200 0.6 cm
- 09-324-200 0.9 cm
- 09-325-200 1.2 cm
- 09-326-200 1.5 cm
- 09-327-200 2.0 cm
- 09-328-200 2.5 cm
- 09-329-200 3.0 cm

SMITH PETERSON
20 cm



- 09-330-200 Straight 1.0 cm
- 09-331-200 Straight 1.2 cm
- 09-332-200 Straight 1.5 cm
- 09-333-200 Straight 2.0 cm
- 09-334-200 Straight 2.5 cm
- 09-335-200 Curved 1.0 cm
- 09-336-200 Curved 1.2 cm
- 09-337-200 Curved 1.5 cm
- 09-338-200 Curved 2.0 cm
- 09-339-200 Curved 2.5 cm

STILLE
20 cm



STILLE
20 cm

CHISELS

- 09-340-200 1.0 cm
- 09-341-200 1.2 cm
- 09-342-200 1.5 cm
- 09-343-200 2.0 cm
- 09-344-200 2.5 cm

OSTEOTOME

- 09-345-200 1.0 cm
- 09-346-200 1.2 cm
- 09-347-200 1.5 cm
- 09-348-200 2.0 cm
- 09-349-200 2.5 cm



WALTER

- 09-350-200 10 mm
- 09-351-200 15 mm

20 cm



REIL
 09-352-170
 17 cm



REDUCTION FORCEPS
 09-353-200
 20 cm



09-354-170
 17 cm



09-355-130
 13 cm



LEWIN

09-356-175
 17.5cm



REPOSITION
 09-357-130
 13 cm



09-358-135
13.5 cm



DINGMANN
09-359-180
18 cm



09-360-160
16 cm



09-361-220
22 cm



PATELLA
09-362-185
18.5 cm



09-363-160 16 cm
09-364-240 24 cm
with Thread Lock



**REPOSITION
 FORCEPS**
 09-365-230
 23 cm



HEY GROVES
 09-366-210 21 cm
 09-367-270 27 cm
 09-368-300 30 cm



LANE
 09-369-330 33 cm
 09-370-470 47 cm



LANE
 09-371-330 33 cm
 09-372-470 47 cm



KERN
 09-373-160 16 cm with ratchet
 09-374-210 21 cm with ratchet
 09-375-160 16 cm without ratchet
 09-376-210 21 cm without ratchet



FARABEU-F-LAMBOTTE
 09-377-230 23 cm with ratchet
 09-378-260 26 cm with ratchet
 09-379-230 23 cm mm without ratchet
 09-380-260 26 cm mm without ratchet



SELF-CENTERING

- 09-384-150**
For small Fragments 15 cm, jaw 9 mm
- 09-385-190**
19 cm, Extra small jaw 10 mm
- 09-386-240**
24 cm, small jaw 14 mm
- 09-387-260**
26 cm, medium jaw 18 mm
- 09-388-280**
28 cm, large jaw 23 mm



- ULRICH**
- 09-389-190** 19 cm
 - 09-390-230** 23 cm
 - 09-391-250** 25 cm
 - 09-392-280** 28 cm



- LAMBOTTE**
- 09-393-220** 22 cm
 - 09-394-270** 27 cm
 - 09-395-330** 33 cm



09-396-200
20 cm



SEMB
09-397-190
19 cm



FERGUSON
09-398-230
23 cm



FERGUSON
09-399-210
21 cm



VERBRUGGE
09-400-180
18 cm

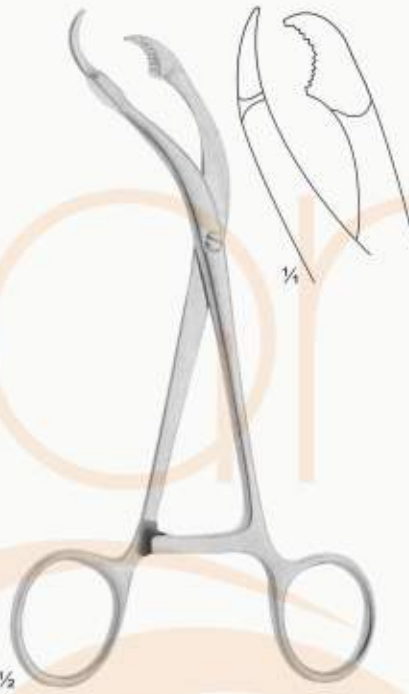

VERBRUGGE
09-401-180
18 cm



VERBRUGGE
09-402-250 25 cm
09-403-260 26 cm
09-404-270 27 cm



VERBRUGGE
09-405-250 25 cm
09-406-260 26 cm
09-407-270 27 cm



VERBRUGGE
09-408-180
18 cm



VERBRUGGE
09-409-250 25 cm
09-410-260 26 cm
09-411-270 27 cm

BONE HOLDING CLAMPS

Knochenhalteklammern
Daviers a os

Pinzas porta huesos
Tenaglie per ossa



1/2

LOWMANN
09-412-130 13.0 cm
09-413-185 18.5 cm
09-414-300 30.0 cm



1/2

LOWMAN-HOGLUND
09-415-175
17.5 cm

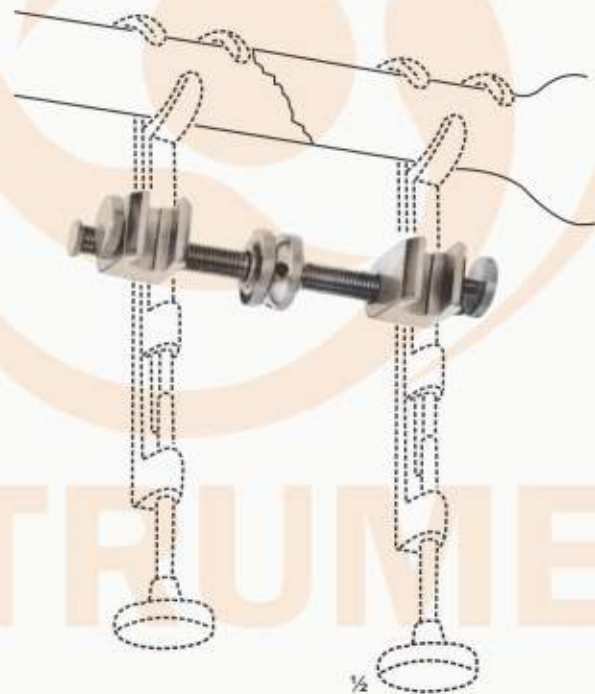

1/2

GERSTER
09-416-180 Blad Jaw 18 cm
09-417-200 Blad Jaw 20 cm
09-418-220 Blad Jaw 22 cm

INSTRUMENTS



**STELLBRINK
 SYNOVCTOMY**
 09-419-175
 17.5 cm

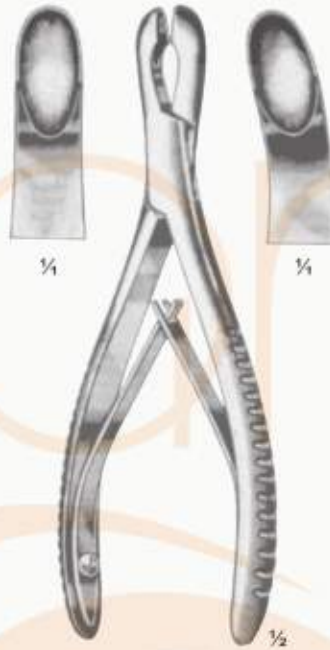

LUER
 09-420-170 17 cm straight
 09-421-170 17 cm curved



LEMPERT
 09-422-190 19 cm straight
 09-423-190 19 cm curved

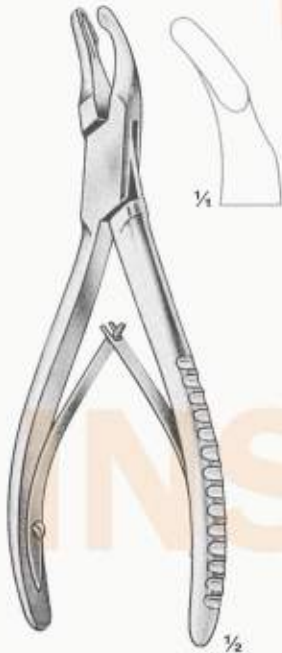

CLEVELAND
 09-424-175 14 cm
 09-425-175 17 cm

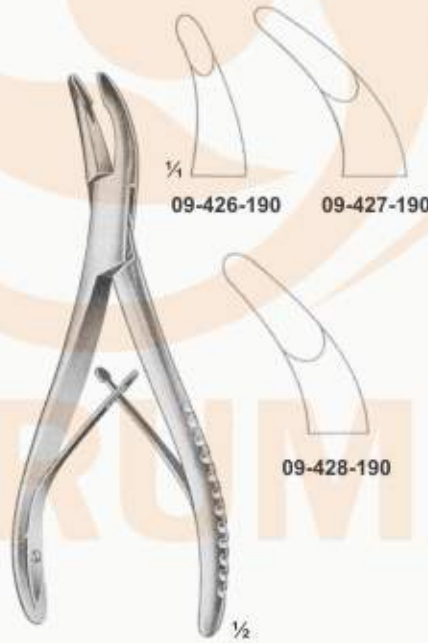

LUER
 15 cm

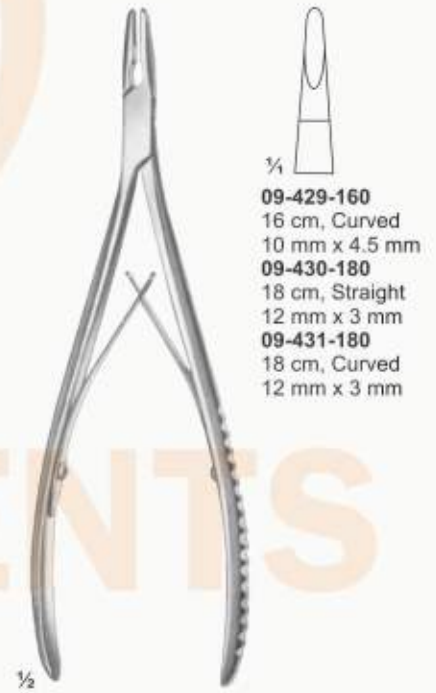

LEMPERT

1/4
09-429-160
 16 cm, Curved
 10 mm x 4.5 mm
09-430-180
 18 cm, Straight
 12 mm x 3 mm
09-431-180
 18 cm, Curved
 12 mm x 3 mm



MEAD
16 cm



MARTMANN
09-434-190
18.5 cm

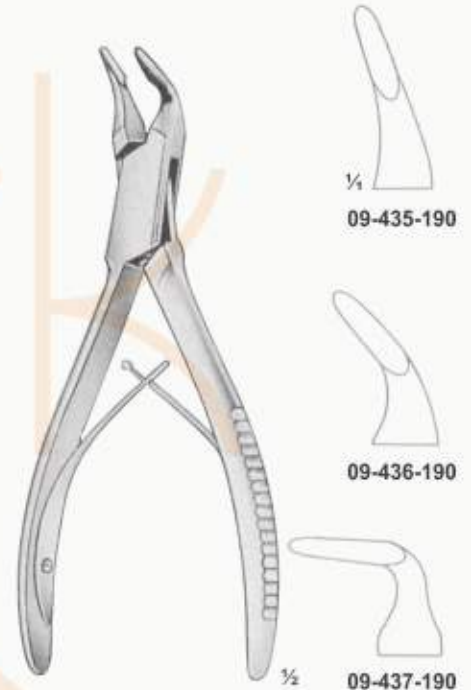

BLUMENTHAL
15.5 cm



**FRIEDMAN &
MINI-FRIEDMAN**

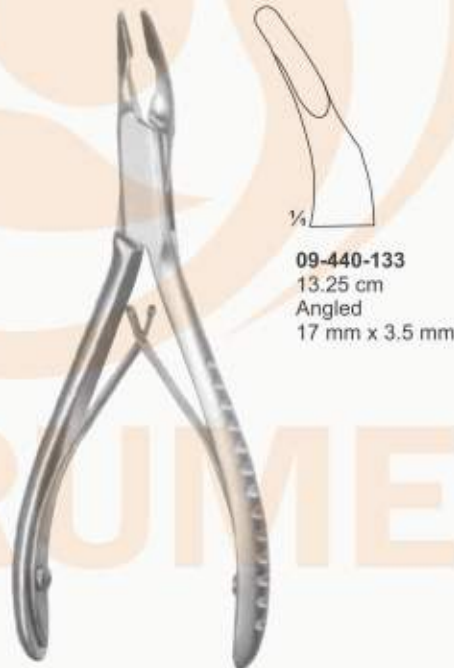

UNIVERSAL



ADSON
09-441-20
20 cm, Straight
15 mm x 7.5 mm



09-442-230
23 cm
18.5 x 7.5 mm

STILLE-RUSKIN



09-443-230 **09-444-230**
23 cm 23 cm
17.5 x 7 mm 17.5 x 5 mm

LEKSELL-STILLE

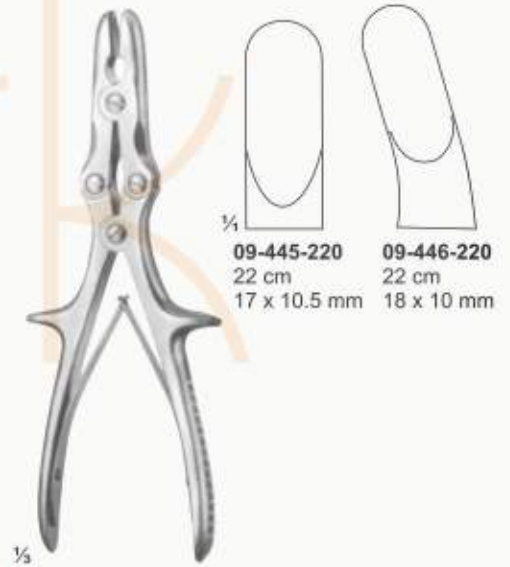

09-445-220 **09-446-220**
22 cm 22 cm
17 x 10.5 mm 18 x 10 mm

STILLE-LUER



09-447-230 **09-448-230**
23 cm 23 cm
Duckbill Duckbill
15 x 2 mm 15 x 6 mm

ECHLIN / STILLE-LUER



BEYER
09-449-180
18 cm, curved

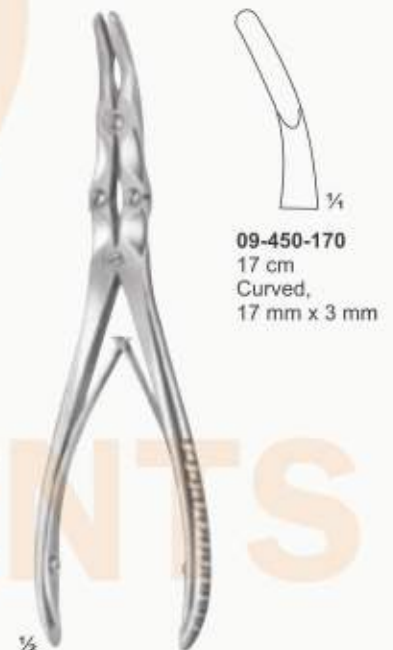

09-450-170
17 cm
Curved,
17 mm x 3 mm

MAYFIELD



09-451-153
 15.25 cm
 Curved
 18 x 5 mm

RUSKIN-MINI



09-452-153
 15.25 cm
 Straight
 5 x 15 mm

BÖHLER



09-453-153
 15.25 cm
 Slight Curve
 5 x 15 mm

RUSKIN



09-454-180
 18 cm
 Slightly Curved
 16.5 x 5.5 mm

BEYER



09-455-180
 18 cm
 Curved
 18 x 3.5 mm

ZAUFAL-JANSEN



09-456-180
 18 cm
 Slightly Curved
 18 x 4 mm

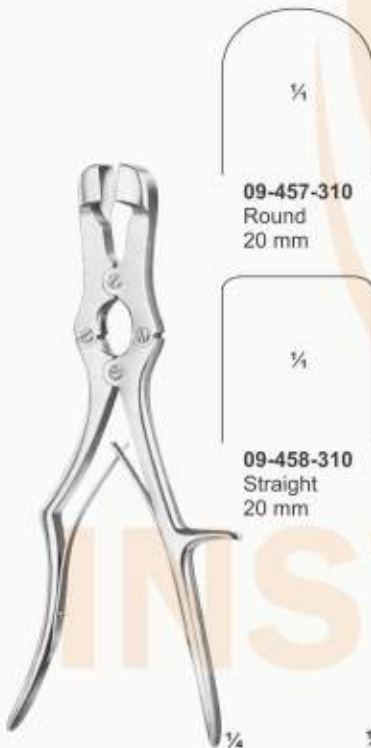

09-457-310
 Round
 20 mm

SAUERBRUCH
 31 cm



09-458-310
 Straight
 20 mm

SEMB



09-459-230
 23 cm
 11 x 15 mm

STILLE



09-460-230
 23 cm
 Duckbill
 17 mm x 6 mm



09-461-230
 23 cm
 Double-Action
 Fully Curved
 Jaw 7mm x 13mm wide
 3 mm, 5 mm, 8 mm

LEKSELL



LISTON
 09-462-180
 18 cm



09-463-001



09-464-002



09-465-003



LISTON
 09-466-170 17 cm
 09-467-190 19 cm
 09-468-220 22 cm
 curved on flat



1/4



09-469-200
 20 cm



1/4

1/2

MARKWALDER



DURAY STAMM
 09-470-150
 15 cm



RUSKIN-LISTON



21 mm
 09-471-190
 19 cm, Straight
 09-472-190
 19 cm, Curved



STILLE-LISTO



09-473-270
 27 cm
 Straight, 36 mm
 Curved



LISTON



09-474-235
 23.5 cm
 Angled, 28 mm

1/4

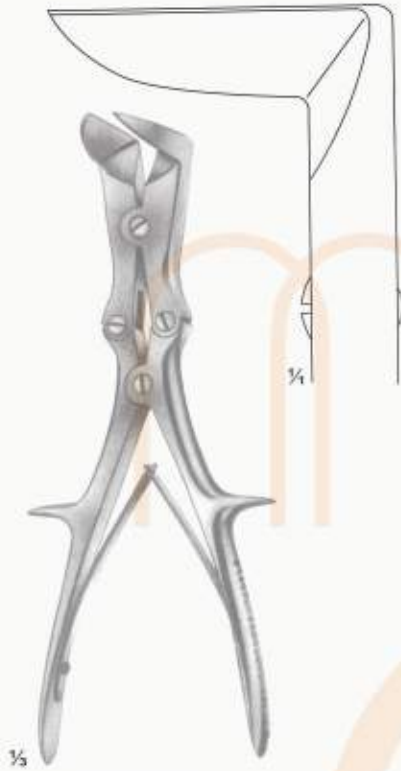

LISTON-STILLE
09-475-260
26 cm



Mc INDOE
09-476-175
17.5 cm



BOHLER
09-477-150 15 cm straight
09-478-150 15 cm curved



RUSKIN
09-479-200
20 cm



HORSLEY
09-480-250
25 cm



LISTON-KEY (HORSLEY)
09-481-270
27 cm
Angled, 28 mm



KNEE RETRACTOR
 09-482-210
 21 cm

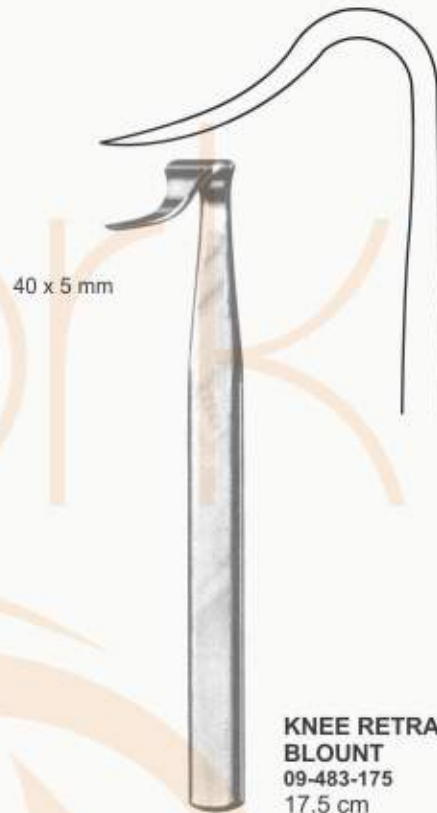

**KNEE RETRACTOR
 BLOUNT**
 09-483-175
 17.5 cm



HERZ
 09-484-230
 23 cm



Non-traumatic serration guarantees safe gripping and protects the resected tissue for histological examination.

1/4



JAGER
 09-485-235
 23.5 cm

INSTRUMENTS

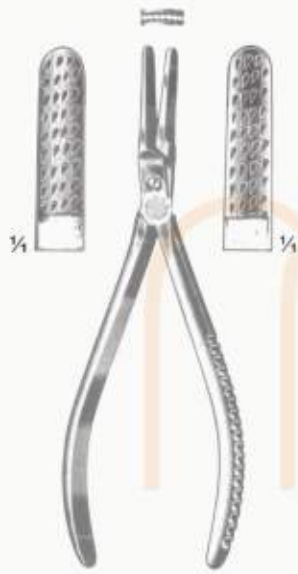

**NAIL EXTRACTING
 FORCEPS**
 09-486-140
 14 cm



**NAIL EXTRACTING
 FORCEPS**
 09-487-145
 14.5 cm



09-488-000
 Finger nail drill with 3
 drill points

Frill points only



**NAIL SPLITTING
 FORCEPS**
 09-492-135
 13.5 cm



RING CUTTER
 09-493-170
 17 cm



09-494-00
 Saw Blade Only
 for 09-493-170



RING CUTTER
 09-495-170
 17 cm



09-496-00
 Saw Blade Only
 for 09-495-170



1/2

09-497-160
 16.0 cm



1/2

09-498-150
 15.0 cm



1/2

PERTHES
09-499-160 16 cm
09-500-220 22 cm



1/2

KOCUER
09-501-230
 23 cm
 3 cm Dia.



Bone Drills

09-503-001 **09-504-002**



1/4



1/4

OBWEGESER
09-505-230
 23 cm



1/4

OBWEGESER
09-506-195
 19.5 cm

Awls for wire suture



1/4

BRUNNER
09-507-300
 30 cm



1/4

MALLEABLE
09-508-230
 23 cm

ESMARCH
09-502-200
 with 2 drill points
 (09-321-200 + 09-322-200)
 20 cm



KIRSCHNER

- 09-509-00 40 x 140 mm
- 09-510-00 60 x 220 mm

KIRSCHNER, AMERICAN TYPE

- 09-511-130 Medium 13.0 cm
 - 09-512-185 Large 18.5 cm
 - 09-513-220 Extra Large 22.0 cm
- Max. Jaw Opening

KIRSCHNER

- 09-514-00 200 mm x 155 mm
- 09-515-00 155 mm x 155 mm
- 09-516-00 135 mm x 130 mm
- 09-517-00 120 mm x 120 mm
- 09-518-00 105 mm x 100 mm
- 09-519-00 95 mm x 110 mm
- 09-520-00 95 mm x 70 mm

SCREW NUT WRENCH

- 09-521-00
- 14 x 17 mm



CHARNLEY-MUELLER

- 09-522-00
- Compression Clamp

Inside Length Inside Width

- 09-523-00 90 mm 75 mm
- 09-524-00 160 mm 90 mm
- 09-525-00 210 mm 110 mm
- 09-526-00 210 mm 150 mm

WIRE TIGHTENING

- 09-527-180
- 18 cm



09-528-153
 15.25 cm
 6 mm

TENDON



BRAND
 09-529-150 15 cm
 09-530-190 19 cm
 09-531-240 24 cm



BRAND
 09-532-150 15 cm
 09-533-190 19 cm
 09-534-240 24 cm



CARROLL
 09-535-130
 13 cm
 Curved Shaft
 2 mm x 6 mm



LEAD HAND
 09-536-00
 Adult Size



WIRE HOLDING
 09-537-200 20 cm
 09-538-250 25 cm



WIRE HOLDING
 09-539-180 18 cm
 with serrated jaws



WIRE BENDING CUTTING
 09-540-100 10 cm



WIRE BENDING PLIERS
 09-541-100 10 cm



WIRE HOLDING



09-542-170
 17 cm



09-543-170
 17 cm



WIRE HOLDING



09-544-140
 14 cm
 Serrated-Groove



EXTRACTION PLIERS
 09-545-130 13 cm
 09-546-180 18 cm



ORTHOPAEDICS

Orthopädie
Ortopedia

Orthopédie
Ortopedia



1/2

WIRE HOLDING
09-547-180 18 cm



1/2

LOCKING PLIERS



1/4

09-548-150
15 cm
With Spring
serrated



1/2

WIRE HOLDING
09-549-210 18 cm



1/2

SLIP JOINT

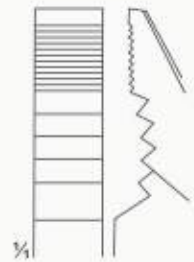

1/4

09-550-195
19.5 cm

INSTRUMENTS

WIRE CUTTING INSTRUMENTS

Drahtschneidezangen
Pinces coupantes

Alicates para cortar alambre
Pinze taglia Filo



1/2

09-551-150
15 cm



1/2

DIAMANT PIN CUTTER
09-552-160
16 cm



1/4

3.5 mm
2.5 mm

1/4

09-553-220
22 cm



1/4

09-554-320
32 cm
3.0 mm, 3.0 mm



1/2

09-555-235
23.5 cm

1/4

3.0 mm
2.2 mm

1/4



09-556-140
14 cm
1.2 mm



1/4

2.0 mm
1.6 mm

1/4

09-557-240
24 cm



GIGLI SAW
09-558-030 30 mm
09-559-040 40 mm
09-560-050 50 mm
09-561-070 70 mm
stainless



GIGLI HANDLE
09-562-00



**ENGEL
PLASTER SAW**
09-563-155
15.5 cm



CHARRIERE
09-564-250 25 cm
09-565-270 27 cm
Double saw



CHARRIERE
09-566-270 27 cm
09-567-300 30 cm



CHARRIERE
09-568-350
35cm



SATTERLEE
09-569-310
31cm



PERCY RETRACTOR
09-570-00

PLASTER SHEARS

GipsScheren
 Tijeras Yeso

plâtres Ciseaux
 Cesioie in gesso



PLASTER-BRUNS
 09-571-240
 24 cm
 Saw Edge



SEUTIN
 09-572-230
 23.0 cm



BOHLER
 09-573-180 18 cm
 09-574-240 24 cm



$\frac{1}{2}$
STILLE
 09-575-200 20 cm
 09-576-230 23 cm
 09-577-260 26 cm
 09-578-370 37 cm



$\frac{1}{2}$
HENNIG
 09-579-280
 28 cm



MODEL USA

$\frac{1}{4}$
 09-580-230
 23 cm
 3 Prong



KEY
 With Fiber
 09-581-180
 Handle 18 cm



SCREW DRIVER
 09-582-00
 slotted head



SCREW DRIVER
 09-583-00
 philips head



SCREW DRIVER
 09-584-00
 single head



**BONE SCREW
 HOLDING FORCEPS**
 09-585-00
 Bone Screw



**BONE PLATE
 HOLDING FORCEPS**
 09-586-00
 Bone Plate



BENDING PLIERS
 09-587-00
 2.7 mm & 3.5 mm
 Plates



INSTRUMENTS

WIRE CUTTING INSTRUMENTS T.C.

Drahtschneidezangen
Pinces coupantes

Alicates para cortar alambre
Pinze taglia Filo



EXTRACTION PLIERS
09-588-180 18 cm
09-589-180 18 cm



EXTRACTION PLIERS
09-590-200 20 cm



EXTRACTION PLIERS
09-591-200 20 cm



EXTRACTION PLIERS



WIRE CUTTERS
09-594-180 18 cm



WIRE CUTTERS
09-595-180 18 cm
09-596-210 21 cm



WIRE CUTTERS
09-597-180 18 cm

WIRE CUTTING INSTRUMENTS T.C.

Drahtschneidezangen
Pinces coupantes

Alicates para cortar alambre
Pinze taglia Filo



UNIVERSAL SCISSORS

09-598-100 10 cm
 09-599-120 12 cm



WIRE CUTTER

09-600-180 18 cm

1/2



WIRE CUTTERS

09-601-180 18 cm

3/4



1/4

WIRE CUTTERS

09-602-460 46 cm
 09-603-560 56 cm



WIRE CUTTERS

09-604-180 18 cm
 09-605-220 22 cm

1/2



3/4

2.0 mm
 1.6 mm



09-606-240 24 cm

1/2

SECTION - 10

CARDIOVASCULAR AND THORACIC INSTRUMENTS



BULLDOG CLAMPS

Bulldogklemmen
Clamps Bulldog

Clamps Bulldog
Pinze Bulldog



DEBAKEY



10-001-080
Length 8 cm
Jaw 2 cm
Straight



10-002-090
Length 9 cm
Jaw 3 cm
Straight



10-003-105
Length 10.5 cm
Jaw 4.5 cm
Straight



10-004-125
Length 12.5 cm
Jaw 6.8 cm
Straight



DEBAKEY



10-005-075
Length 7.5 cm
Jaw 2 cm
Curved



10-006-085
Length 8.5 cm
Jaw 3 cm
Curved



10-007-095
Length 9.5 cm
Jaw 4.5 cm
Curved



10-008-115
Length 11.5 cm
Jaw 6.8 cm
Curved

BULLDOG CLAMPS

Bulldogklemmen
Clamps Bulldog

Clamps Bulldog
Pinze Bulldog



BULLDOG CLAMP



1/4

10-009-038
3.8 cm



10-010-038
3.8 cm



10-013-060
6 cm



10-011-051
5.1 cm



10-012-060
6 cm



10-014-060
6 cm



DIETRICH/MICRO CORONARY



10-015-050
5 cm
Straight, 8 mm



10-016-050
5 cm
Angled, 8 mm



10-017-050
5 cm
Angled, 12 mm



BULLDOG CLAMP

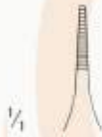

1/4

10-018-049
Length 4.9 cm
Jaw 8 cm
Straight



10-019-053
Length 5.3 cm
Jaw 1.2 cm
Straight

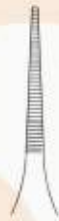

10-020-059
Length 5.9 cm
Jaw 2 cm
Straight



10-021-043
Length 4.3 cm
Jaw 8 cm
Curved



10-022-045
Length 4.5 cm
Jaw 1.2 cm
Curved



10-023-050
Length 5 cm
Jaw 2 cm
Curved



10-024-040
Titan 4 cm



10-025-040
Titan 4 cm



10-026-040
Titan 4 cm



10-027-040
Titan 4 cm
Full Curved

BULLDOG CLAMPS

Bulldogklemmen
Clamps Bulldog

Clamps Bulldog
Pinze Bulldog

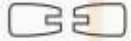

10-028-049
Length 4.9 cm
Jaw 1.3 cm
Straight

10-029-054
Length 5.4 cm
Jaw 1.8 cm
Straight

10-030-061
Length 6.1 cm
Jaw 2.5 cm
Straight



10-031-047
Length 4.7 cm
Jaw 1.3 cm
Curved



10-032-051
Length 5.1 cm
Jaw 1.8 cm
Curved



10-033-055
Length 5.5 cm
Jaw 2.5 cm
Curved



WICKHAM
10-034-240
24 cm



10-035-047
Length 4.7 cm
Jaw 1 cm
Straight



10-036-051
Length 5.1 cm
Jaw 1.4 cm
Straight



10-037-057
Length 5.7 cm
Jaw 2 cm
Straight



10-038-044
Length 4.4 cm
Jaw 1 cm
Curved



10-039-046
Length 4.6 cm
Jaw 1.4 cm
Curved



10-040-049
Length 4.9 cm
Jaw 2 cm
Curved



10-041-054
Length 5.4 cm
Jaw 2 cm
Curved



JOHN-HOPKINS
10-042-245
24.5 cm

WICKHAM MINI

DEBAKEY-DIETRICH

APPROXIMATORS, BIEMER CLIPS

Approximateurs, Gefäßclips nach Biemer
Approximateurs, clips selon Biemer

Approximadores, Biemer clips
Approssimatori, clips vascolari Biemer



DE BAKEY



10-052-000
11 cm



10-053-075

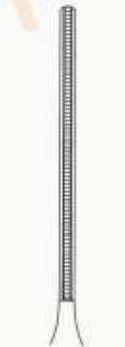

Bulldog



DE BAKEY



10-059-105
10.5 cm

10-060-120
12 cm

VEIN ARTERY



10-061-030
10-062-030
3 cm

10-063-035
10-064-035
3.5 cm

10-065-040
10-066-040
4 cm

10-067-055
10-068-055
5.5 cm



VEIN ARTERY

10-069-030
10-070-030
3 cm

10-071-035
10-072-035
3.5 cm



VEIN ARTERY

10-073-040
10-074-040
4 cm

10-075-055
10-076-055
5.5 cm

VASCULAR FORCEPS

INSTRUMENTS

Gefäßklemmen Pinzas vasculares
 Pincas vasculaires Pinze vascolari



DE BAKAY



10-078-200
 20 cm
 Straight

10-079-200
 20 cm
 Angular



DE BAKAY



10-080-210
 21 cm
 Straight

10-081-210
 21 cm
 Angular



DE BAKAY

10-082-265
 26.5 cm



DE BAKAY

10-083-265
 26.5 cm



VASCULAR FORCEPS

Gefäßklemmen Pinzas vasculares
Pinces vasculaires Pinze vascolari



VASCULAR FORCEPS

INSTRUMENTS

Gefäßklemmen Pinzas vasculares
 Pincès vasculaires Pinze vascolari





VASCULAR FORCEPS

Gefäßklemmen Pinzas vasculares
Pinces vasculaires Pinze vascolari

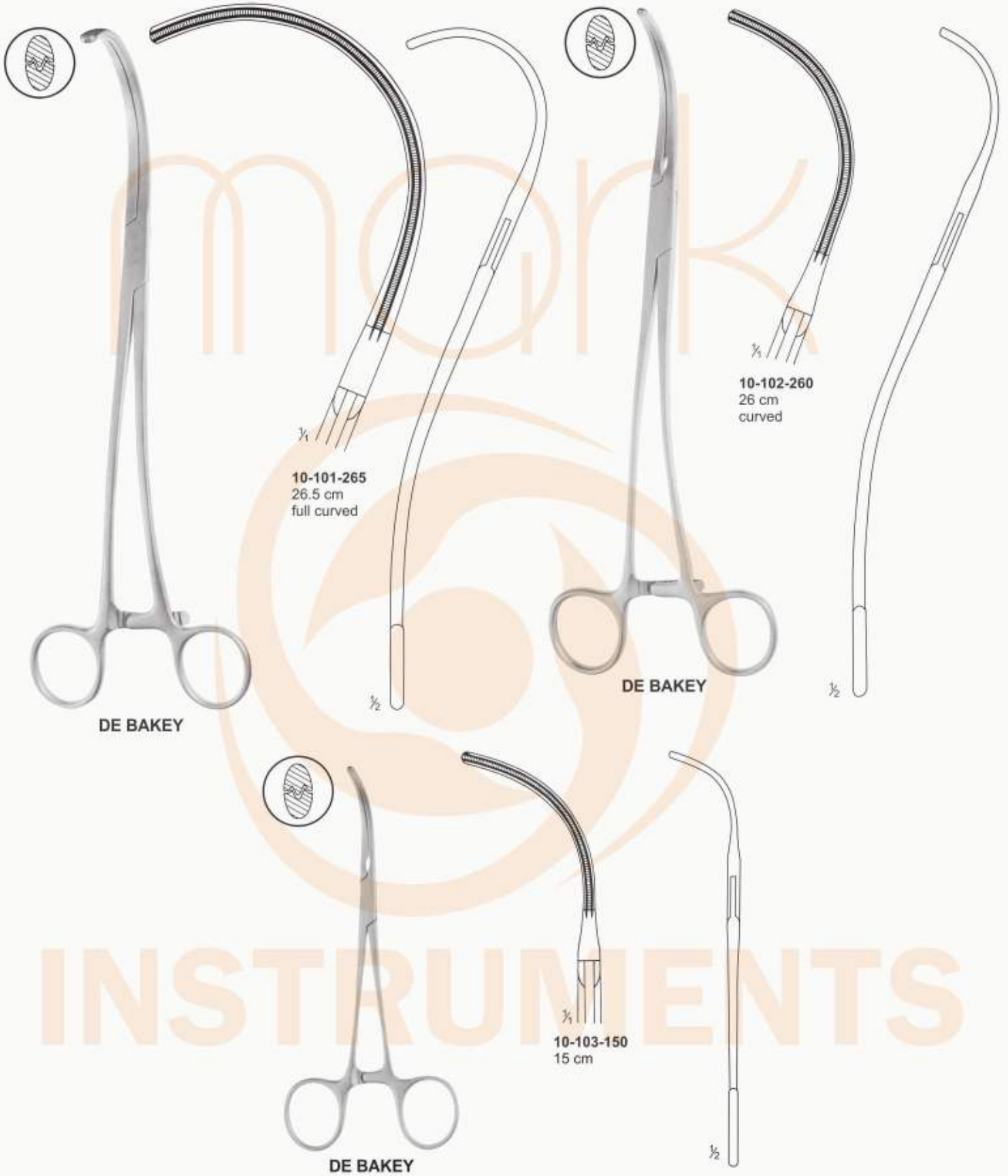

INSTRUMENTS

VASCULAR FORCEPS

Gefäßklemmen Pinzas vasculares
Pincès vasculaires Pinze vascolari



10-104-180
18 cm

DE BAKKEY

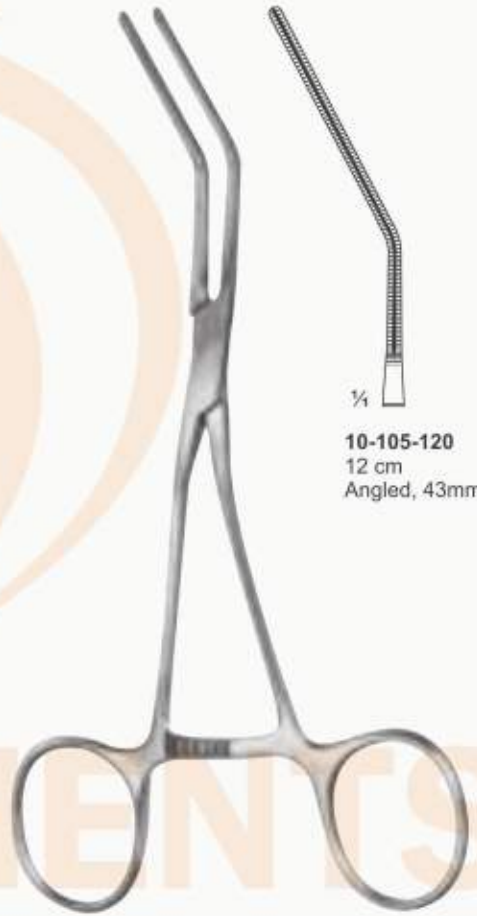

10-105-120
12 cm
Angled, 43mm tip

DE BAKKEY / PEDIATRIC

VASCULAR FORCEPS

Gefäßklemmen Pinzas vasculares
Pincès vasculaires Pinze vascolari

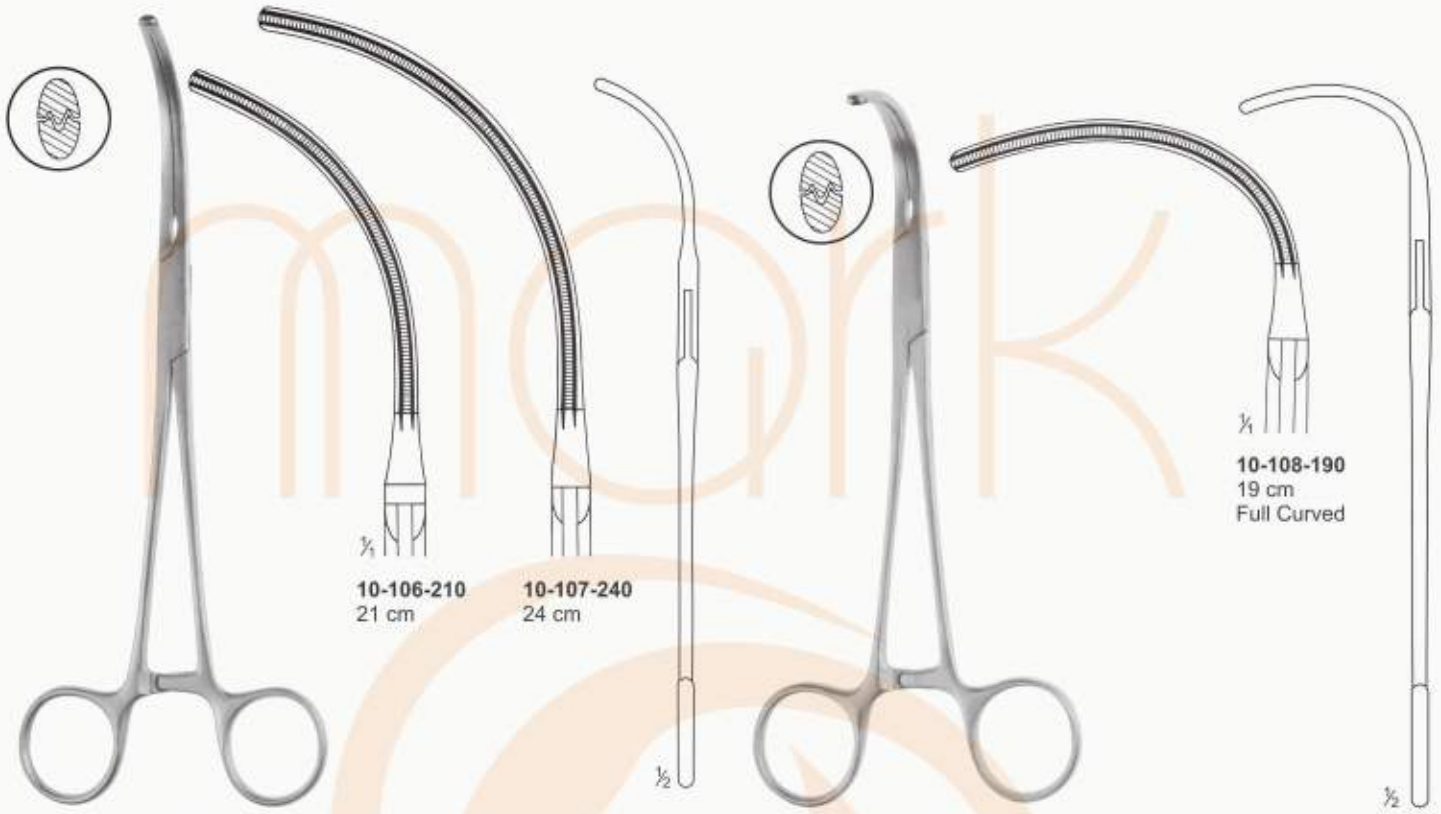

10-106-210
21 cm

10-107-240
24 cm

10-108-190
19 cm
Full Curved

GLOVER

GLOVER

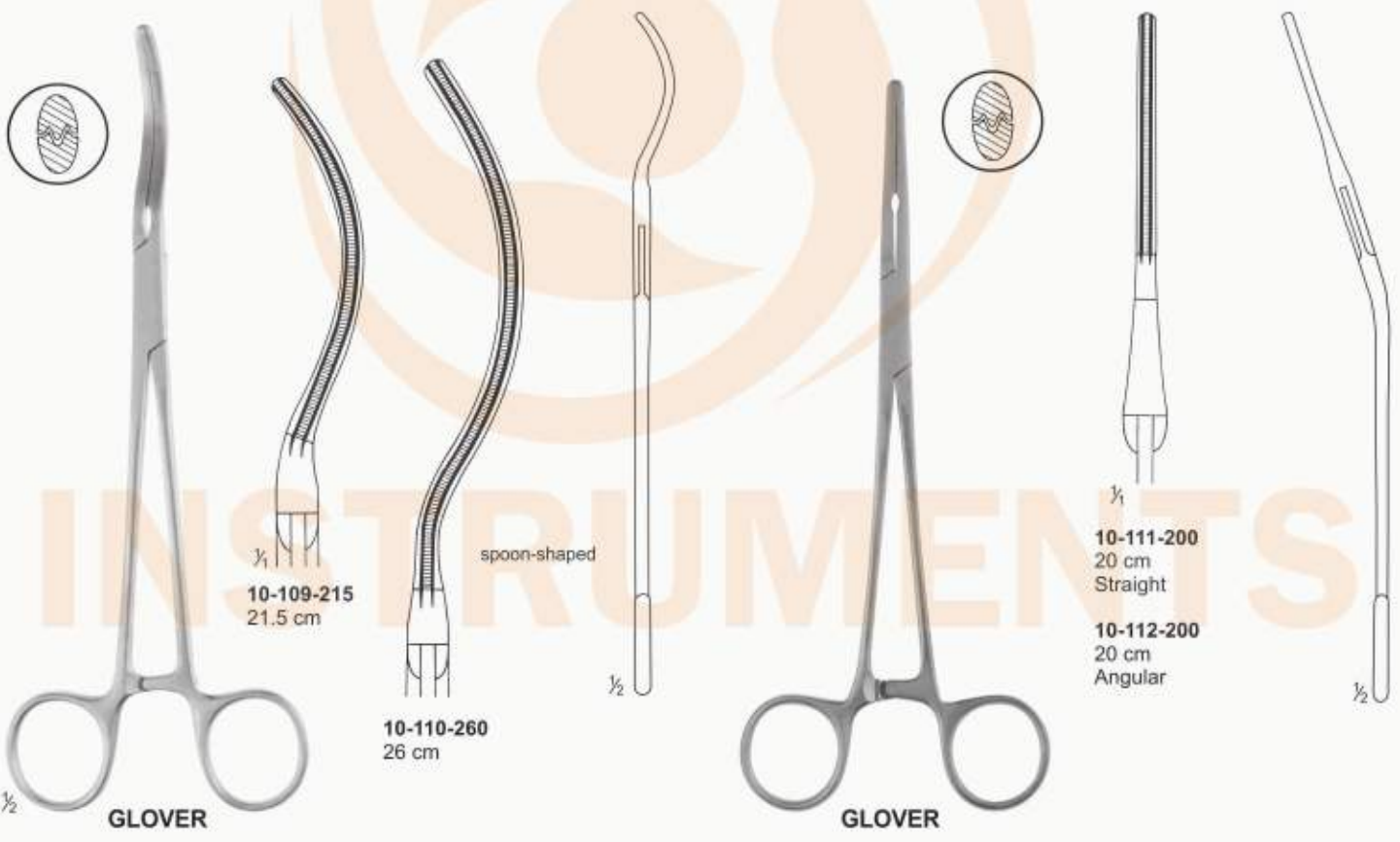

10-109-215
21.5 cm

spoon-shaped

10-110-260
26 cm

10-111-200
20 cm
Straight

10-112-200
20 cm
Angular

GLOVER

GLOVER

VASCULAR FORCEPS

Gefäßklemmen Pinzas vasculares
Pincès vasculaires Pinze vascolari



GLOVER



10-113-220
22 cm
Straight

10-114-220
22 cm
Angular



GLOVER



10-115-250
25 cm



LEES



right angled jaws

10-116-220
22 cm



LEES

double bent

10-117-235
23.5 cm

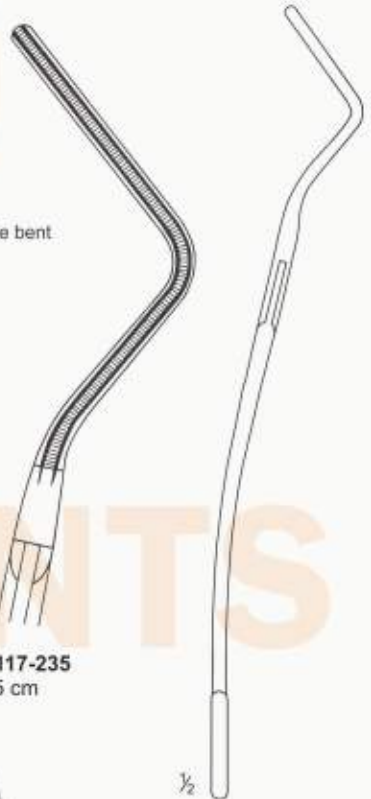

VASCULAR FORCEPS

INSTRUMENTS

Gefäßklemmen Pinzas vasculares
 Pincès vasculaires Pinze vascolari

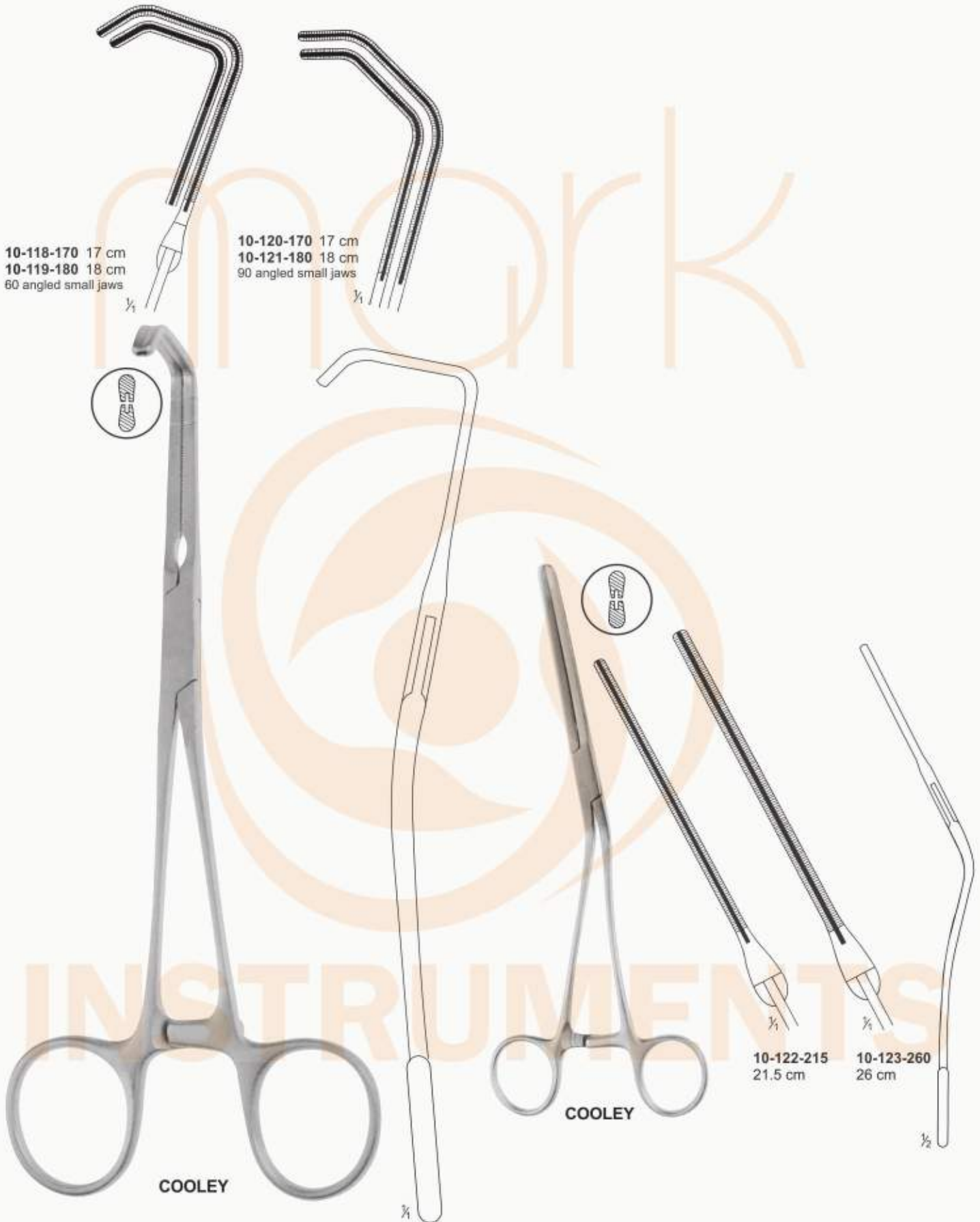

VASCULAR FORCEPS

Gefäßklemmen Pinzas vasculares
 Pincès vasculaires Pinze vascolari

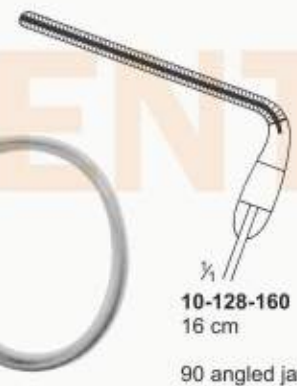
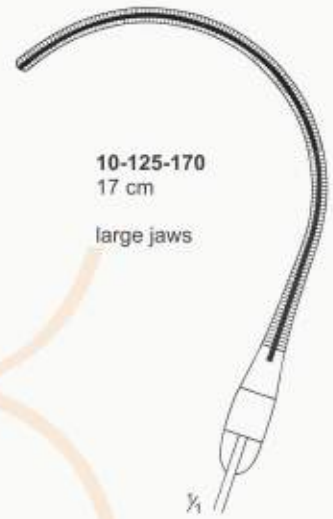

VASCULAR FORCEPS

INSTRUMENTS

Gefäßklemmen Pinzas vasculares
 Pincès vasculaires Pinze vascolari



straight jaws
 angled shanks

10-129-160
 16 cm
 straight shafts
 10-130-160
 16 cm
 angular shafts

COOLEY

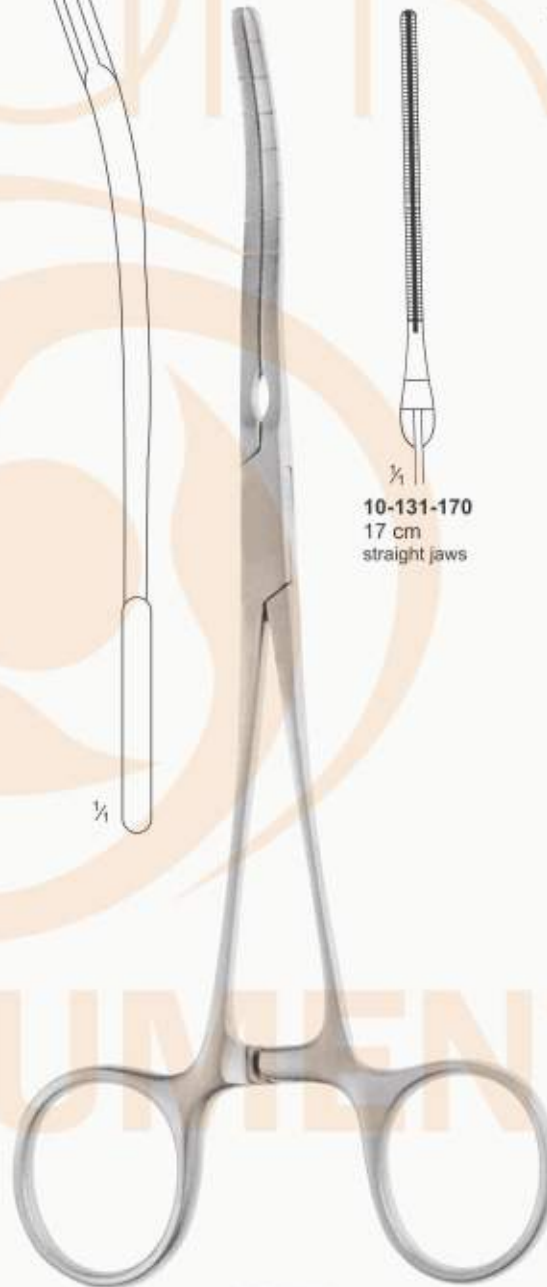

10-131-170
 17 cm
 straight jaws

10-132-170
 17 cm
 curved jaws

10-133-170
 17 cm
 spoon-shaped
 jaws

COOLEY
 clamping forceps for coarctation

INSTRUMENTS



VASCULAR FORCEPS

INSTRUMENTS

Gefäßklemmen Pinzas vasculares
Pincès vasculaires Pinze vascolari



10-134-165
16.5 cm

BECK

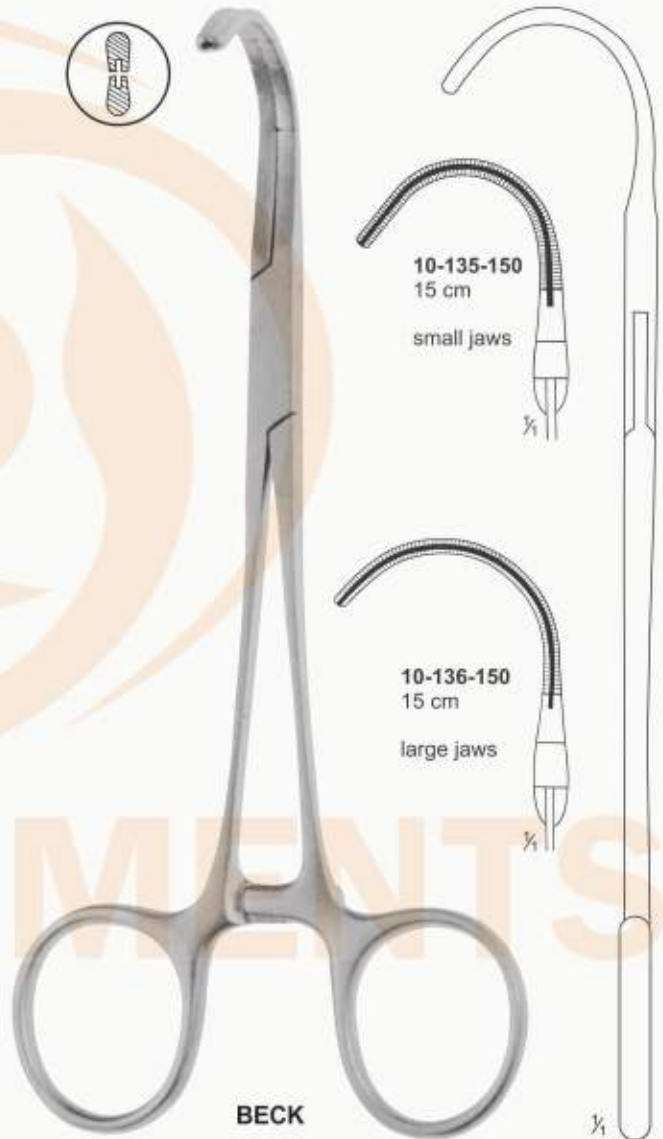

10-135-150
15 cm
small jaws

10-136-150
15 cm
large jaws

BECK

INSTRUMENTS

VASCULAR FORCEPS

Gefäßklemmen Pinzas vasculares
 Pincès vasculaires Pinze vascolari

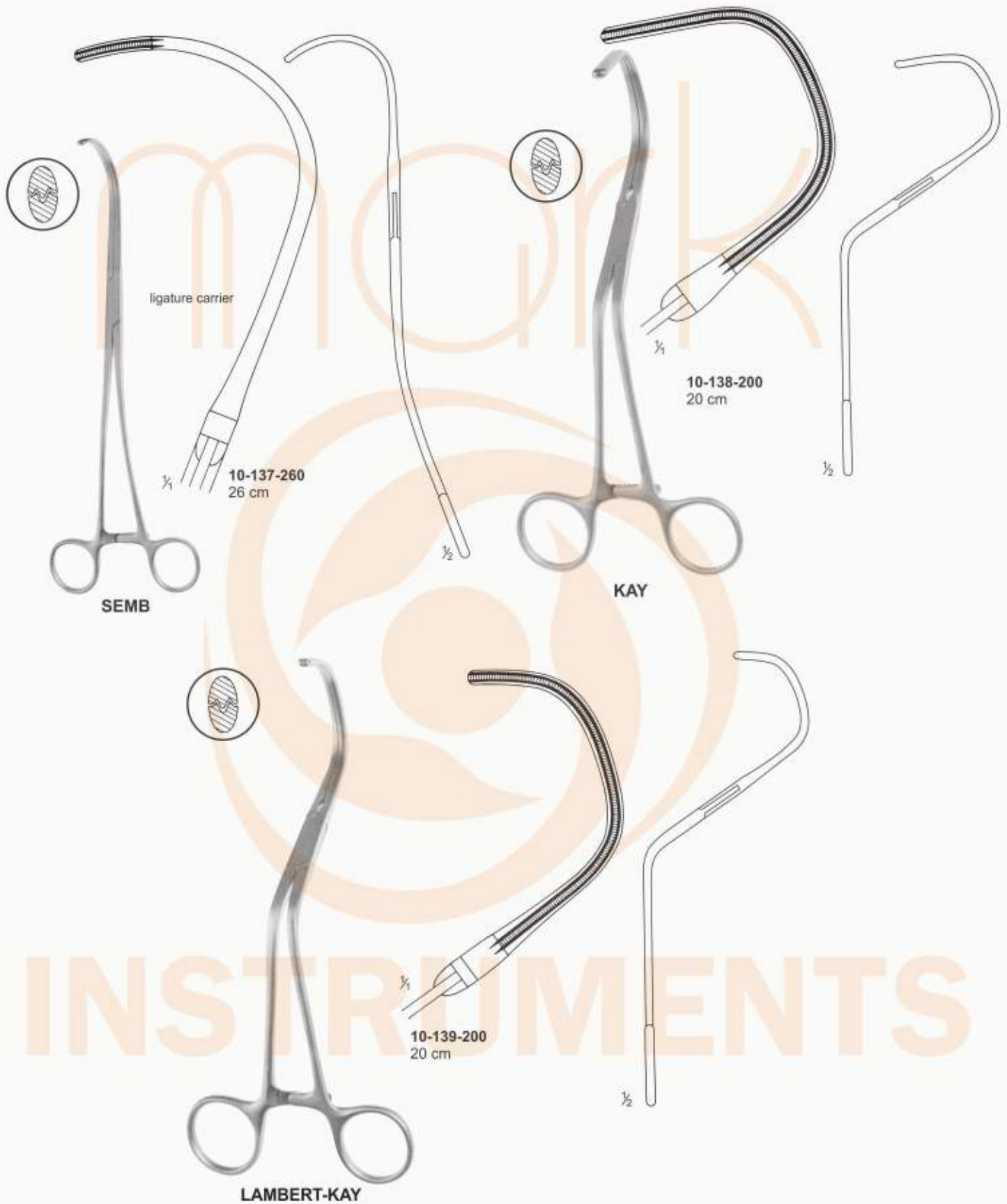

VASCULAR FORCEPS

INSTRUMENTS

Gefäßklemmen Pinzas vasculares
 Pincès vasculaires Pinze vascolari

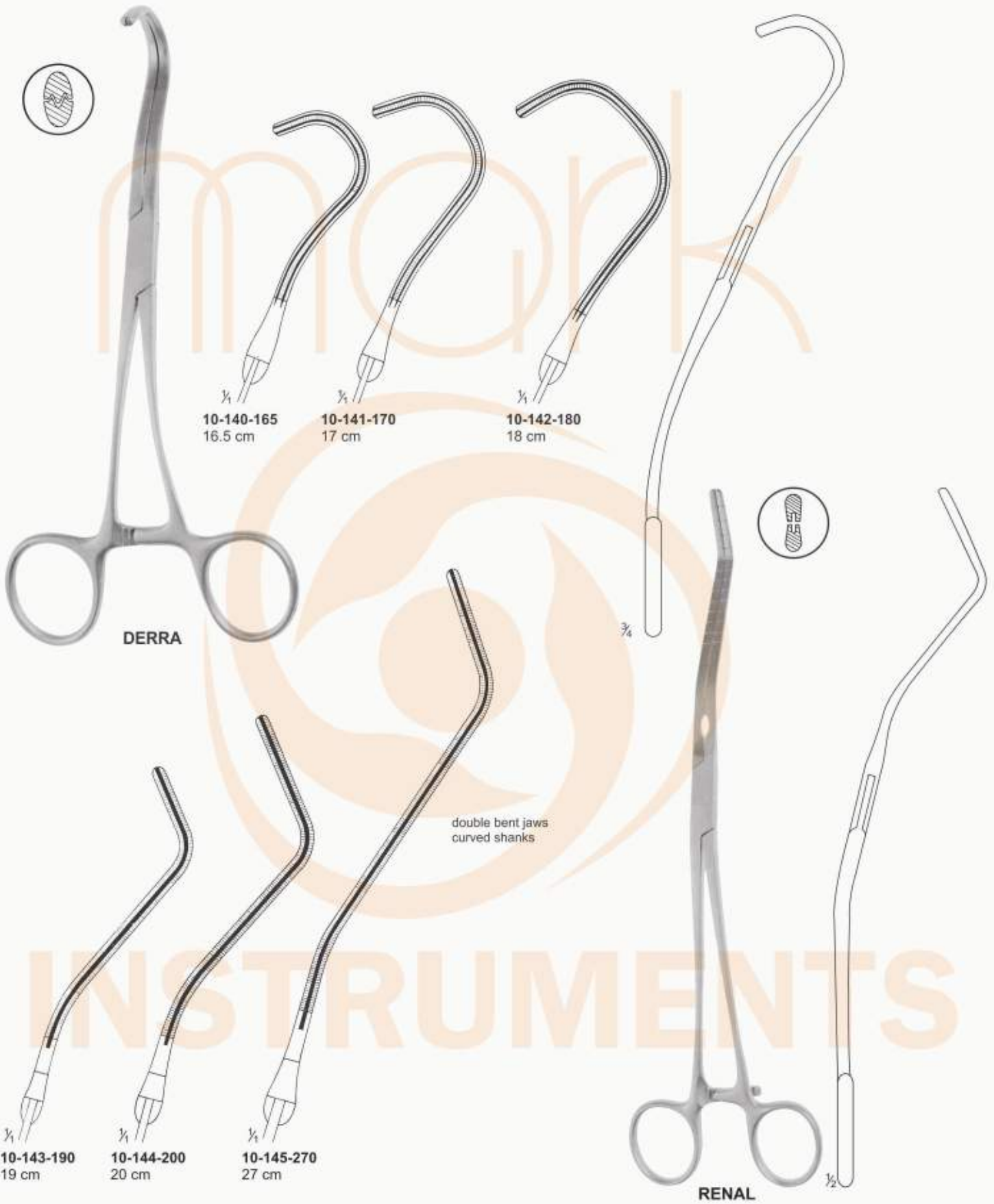



VASCULAR FORCEPS

Gefäßklemmen Pinzas vasculares
 Pincès vasculaires Pinze vascolari



SATINSKY
 10-146-205
 20.5 cm



1/2



1/2
10-147-250
 25 cm

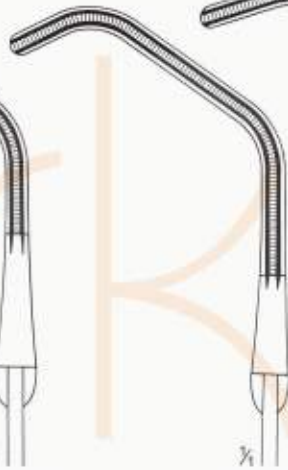

1/2
10-148-250
 25 cm



1/2
10-149-250
 25 cm

VASCULAR FORCEPS

Gefäßklemmen Pinzas vasculares
Pincès vasculaires Pinze vascolari

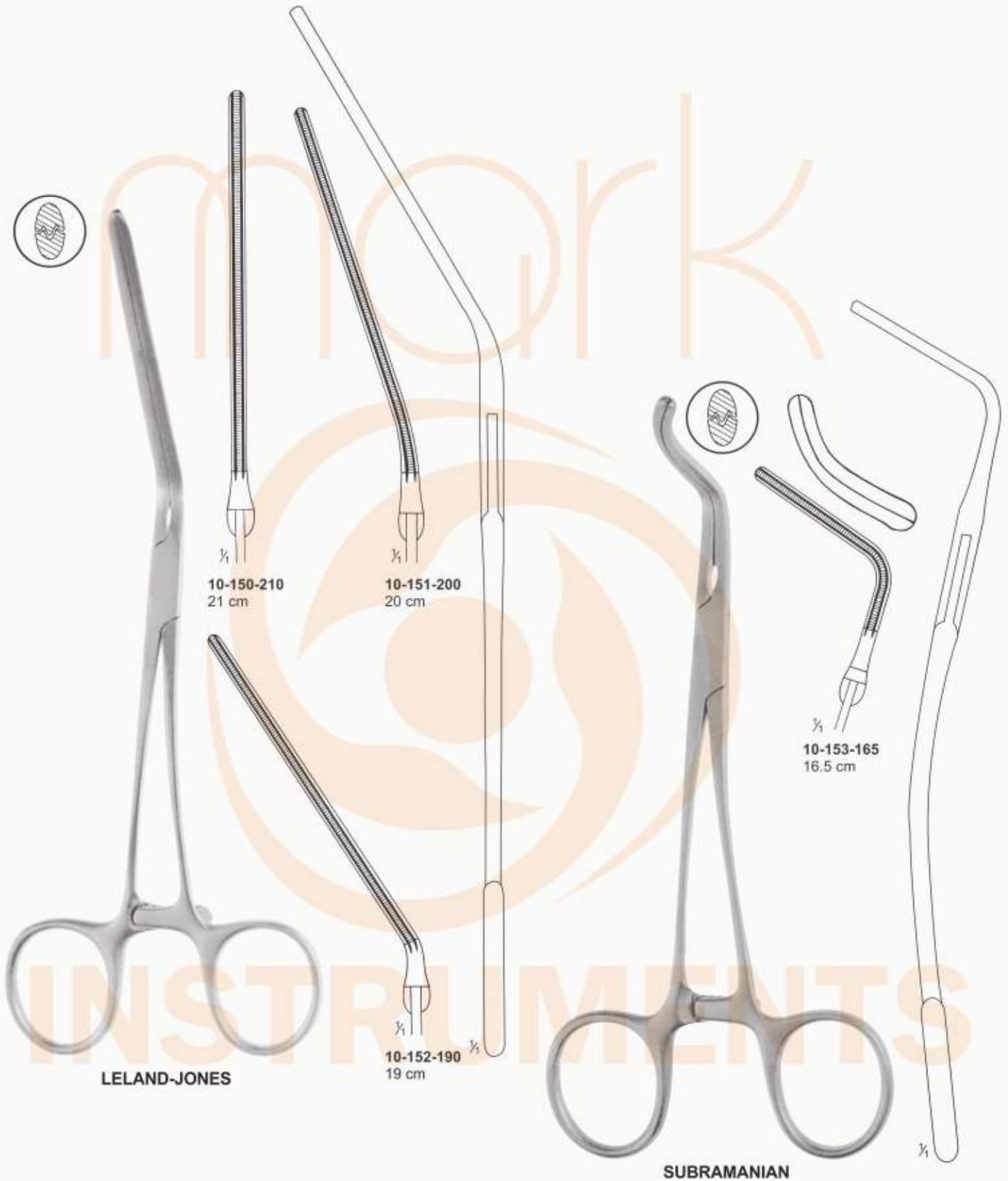

VASCULAR FORCEPS

Gefäßklemmen Pinzas vasculares
 Pincès vasculaires Pinze vascolari

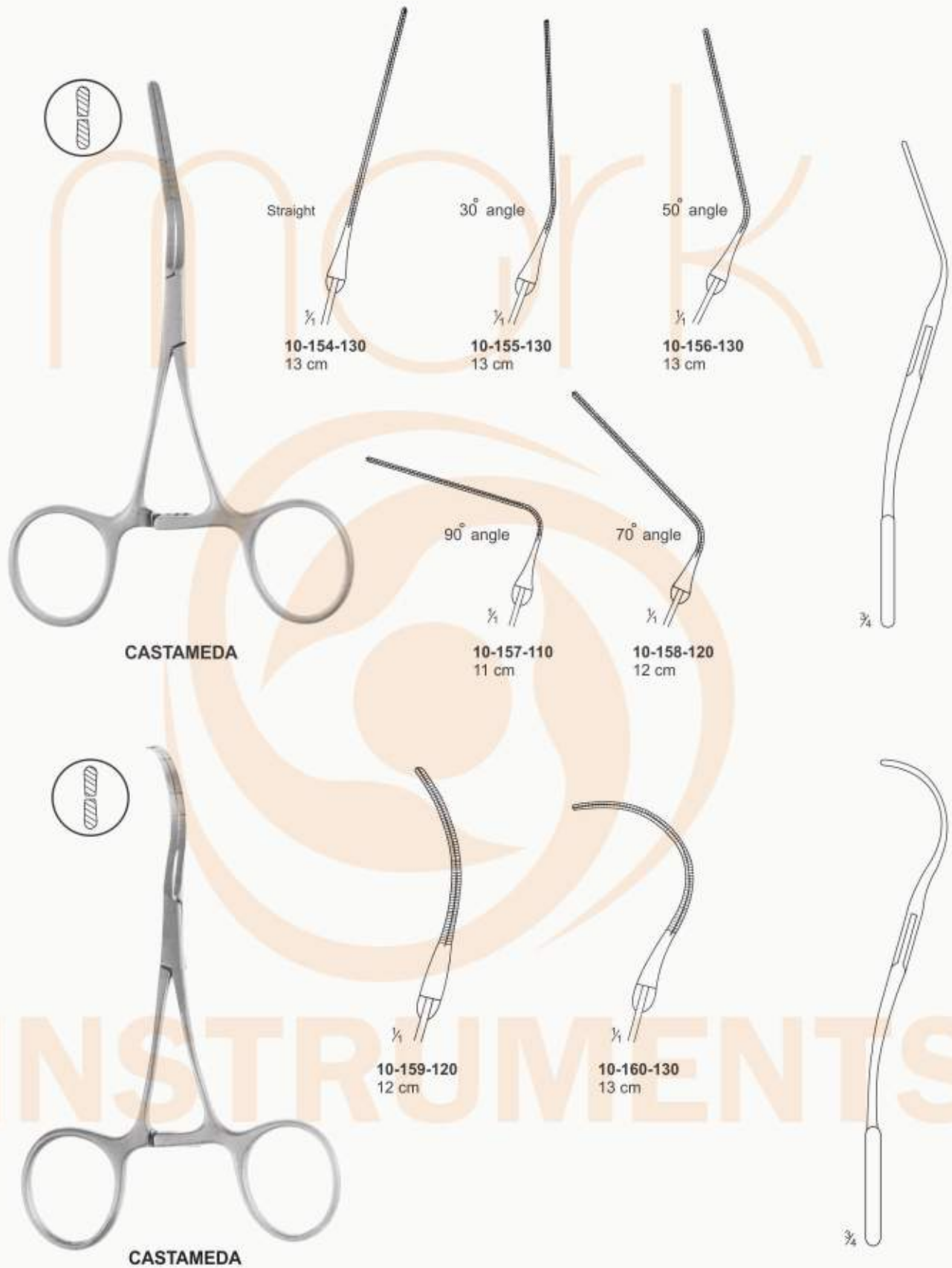

VASCULAR FORCEPS

Gefäßklemmen Pinzas vasculares
 Pincès vasculaires Pinze vascolari



PRICE-THOMAS
22 cm

$\frac{1}{4}$
10-161-220
22 cm



PRICE THOMAS
22 cm

$\frac{1}{4}$
10-162-220
jaw with pins



10-163-220
jaw with pins



BABY-SATINSKY

$\frac{1}{4}$
10-164-150
15 cm

INSTRUMENTS

RIB CONTRACTORS

INSTRUMENTS

Rippenkontraktoren
 Aproximadores para costillas

Rapprocheurs des côtes
 Approssimatori costali



BAILEY-GIBBON
 10-165-200
 20 cm
 For Adult



1/4
 10-166-200
 20 cm
 For children



BAILEY
 10-167-150
 15 cm



SELLORS RIB CONTRACTOR
 10-168-200
 20 cm



BLALOCK



1/4
 10-169-150
 15 cm



10-170-200
 20 cm

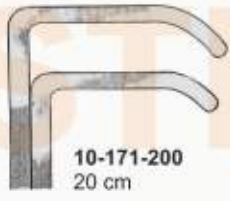

10-171-200
 20 cm



**JOHNS-HOPKINS
 (POTTS Modif.)**



1/4
 10-172-200
 20 cm



10-173-200
 20 cm



10-174-200
 20 cm

LUNG SPATULAS, AORTIC DILATORS

Lungenspatel, Aorta-Dilatatoren

Spatules pulmonaires,

Dilatateurs pour aorte

Espátulas pulmonares, Dilatadores aórticos

Spatole per pulmone,

Dilatatori per aorta



ALLISON
 10-175-250
 25 cm



ALLISON
 10-176-320
 32 cm



10-177-300
 30 cm



TUBBS
 10-178-00
 Blade Opening
 From 8 To 42 mm



COOLEY
 10-179-00
 Blade Opening
 From 8 To 15 mm

VARICOSE VEIN PROBE SET

Krampfaderbesteck
Trousse a varices

Juego para varices
Astuccio per varici



NABATOFF
10-180-000
varicose vein probe
set complete



10-181-000
Plastic Probe tip



10-182-000
3 mm Ø
Olive



10-183-000
6 mm Ø
Olive



10-184-000
9 mm Ø
Olive



10-185-000
12 mm Ø
Olive

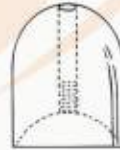

10-186-000
15 mm Ø
Olive

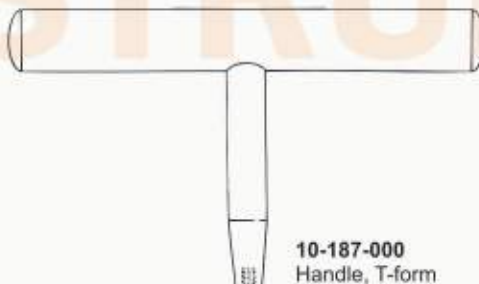

10-187-000
Handle, T-form



TRACTION CABLE
10-188-000

RIB CONTRACTORS

Rippenkontraktoren
Aproximadores para costillas

Rapprocheurs des côtes
Approssimatori costali



COOLEY
10-189-000
lateral blades
12 x 16 mm
spreading 95 mm



COOLEY
10-190-000 lateral blades 15 x 30 mm, spreading 140 mm
10-191-000 lateral blades 21 x 44 mm, spreading 150 mm



COOLEY
10-192-000
lateral blades
35 x 50 mm,
spreading 300 mm

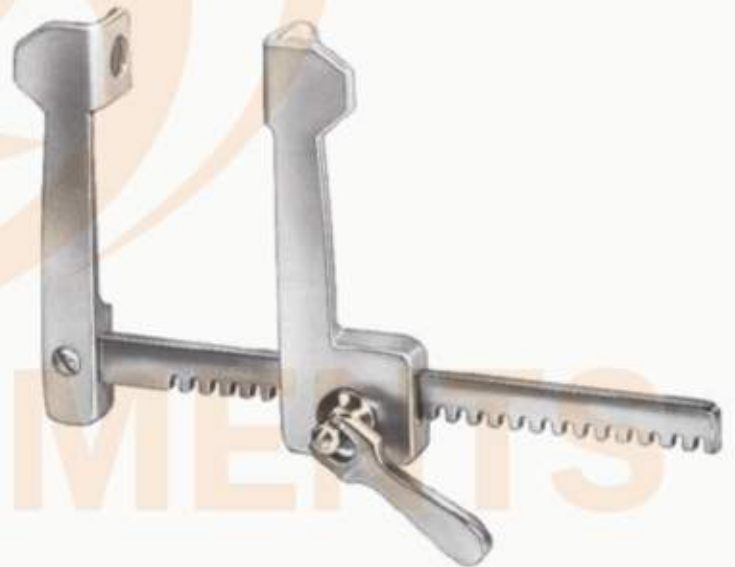

FINOCCHIETTO,
10-193-000
lateral blades
15 x 15 mm, spreading 75 mm

RIB CONTRACTORS

Rippenkontraktoren
Aproximadores para costillas

Rapprocheurs des côtes
Approssimatori costali



HAIGHT
10-194-000
lateral blades 30 x 30 mm,
spreading 120 mm

MORSE-FAVALORO STERNAL
10-195-000
4 movable blades 17 x 22 mm,
spreading 160mm for children



MORSE STERNAL
10-196-000
4 movable blades 27 x 22 mm,
spreading 200 mm for adults

TUFFIER RIB
10-197-000
lateral blades 45 x 45 mm,
spreading 160 mm

RIB CONTRACTORS

Rippenkontraktoren

Aproximadores para costillas

Rapprocheurs des côtes

Approssimatori costali



FINOCCHIETTO, BABY

10-198-000

lateral blades 14 x 15 mm,
spreading 75 mm

FINOCCHIETTO,

10-199-000 lateral blades 30 x 45 mm, spreading 150 mm

10-200-000 lateral blades 46 x 62 mm, spreading 190 mm

10-201-000 lateral blades 80 x 65 mm, spreading 190 mm



THORACIC

10-202-000 Complete set
with 1 pairs of blades



¼

10-203-000

48 x 68 mm
pair



¼

10-204-000

70 x 75 mm
pair



THORACIC & I.M.A

10-205-000 Complete set

10-206-000 lateral blades for I.M.A Retractor
left 40 x 50 x 80 mm

10-207-000 lateral blades for I.M.A Retractor
Right 40 x 50 x 80 mm

RIB CONTRACTORS

Rippenkontraktoren
Aproximadores para costillas

Rapprocheurs des côtes
Approssimatori costali



BURFORD / FINOCCHIETTO,
10-208-180
18 cm
spread with 2 sets of Blades
65 mm x 62 mm
47 mm x 62 mm

INSTRUMENTS

RIB SHEARS, STERNUM CHISEL

Rippenscheren, Sternummeißel
 Costotomos, Cinceles

Costotomes, ciseau-Burin à sternum
 Costotomi, Scalpello per sterno



SAUERBRUCH-FREY
 10-209-370
 for the first rib
 37 cm



SCHUMACHER
 10-210-210
 sternum shears
 21 cm



BONE SHEAR
 10-211-230
 23 cm



RIB SHEAR
 10-212-230
 23 cm



GLUCK
 10-213-210
 21 cm



**LEBSCHE
 STERNUM CHISEL**
 10-214-245
 24.5 cm

RIB SHEARS, STERNUM CHISEL

Rippenscheren, Sternummeißel
 Costotomos, Cinceles

Costotomes, ciseau-Burin à sternum
 Costotomi, Scalpello per sterno

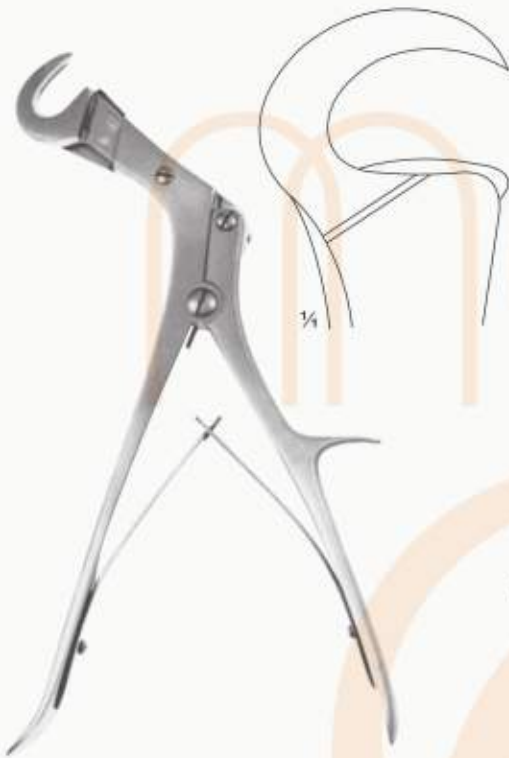

GIERTZ-SEMB
 10-215-280
 28 cm

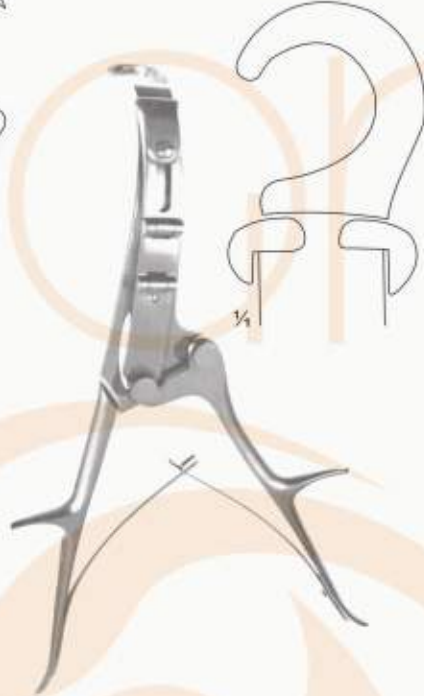

BRUNNER
 10-216-335
 33.5 cm



MAURER-COLLIN



10-217-230
 Hooked Left
 23 cm



10-218-230
 Hooked Right
 23 cm



COLLIN
 10-219-190
 19 cm



DOYEN
 10-220-190
 19 cm



SAUERBRUCH
 10-221-240 24 cm For Children,
 10-222-270 27 cm For Adults,



SCHUARDT
 10-223-170
 17 cm

SECTION - 11

NEUROSURGERY

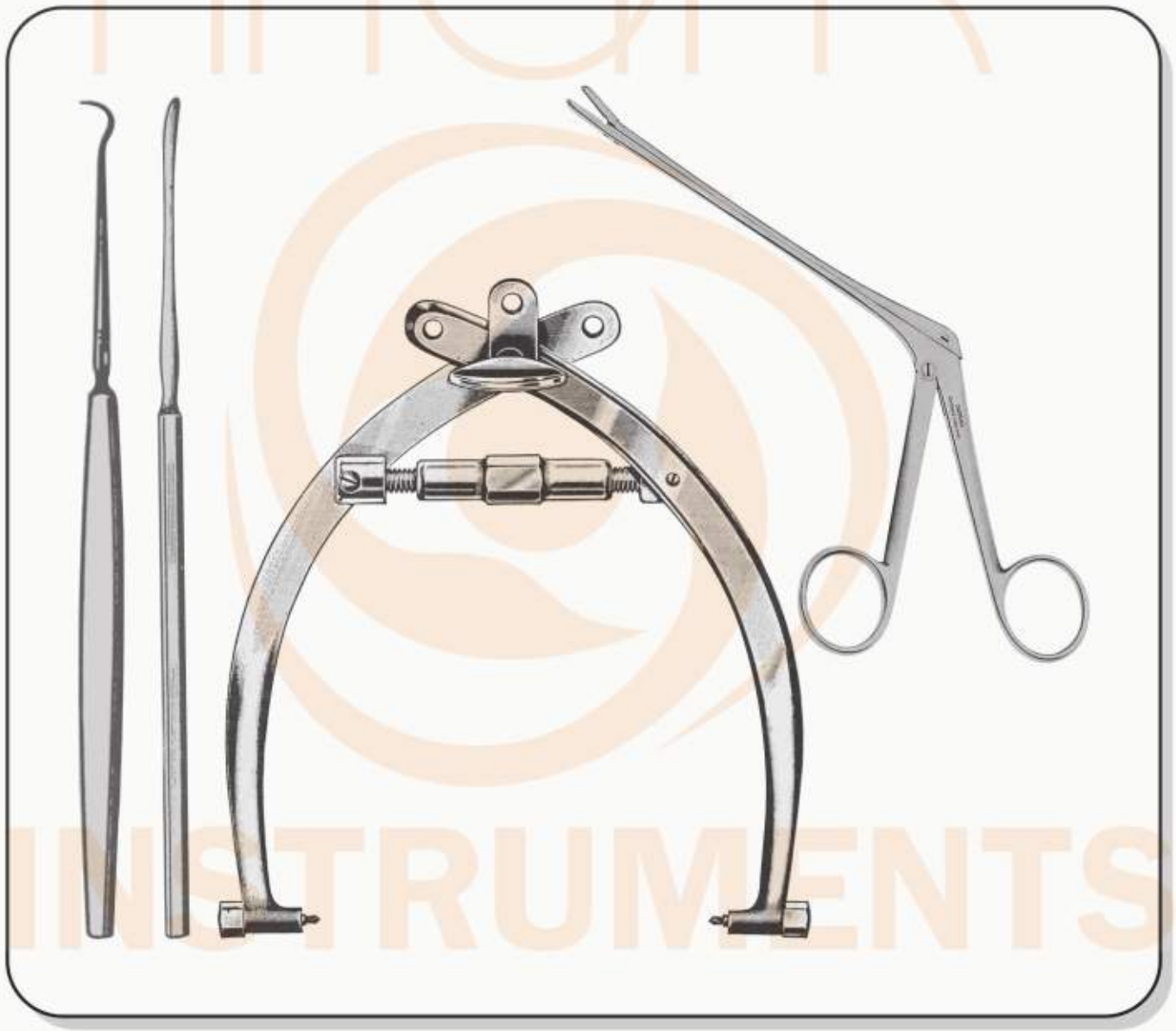

SELF RETAINING BRAIN RETRACTOR

selbsthaltender Hirnretraktor

Separador cerebral autostatico

Retrateur cerebrale autostatique

Retratore celebrale autostatico



11-001-00
wire cable only



11-002-00
Support only,
flat brain spatulas,



11-003-00
Support only,
for brain spatulas
with round shaft
up to 5.5 mm diam.
Fixing for flexible

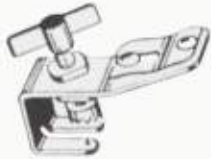

11-004-00
RIECHERT
Fixation base, for skull
mounting, holding 1
flexible arms



11-005-00
RIECHERT
Fixation base, for skull
mounting, holding 2
flexible arms



11-006-00
Fixation base, for skull
mounting, holding 1
flexible arms



LEYLA
Self-Retaining Brain Retractor
with 1 flexible arm, complete consisting of
11-007-00
11-008-00
11-009-00

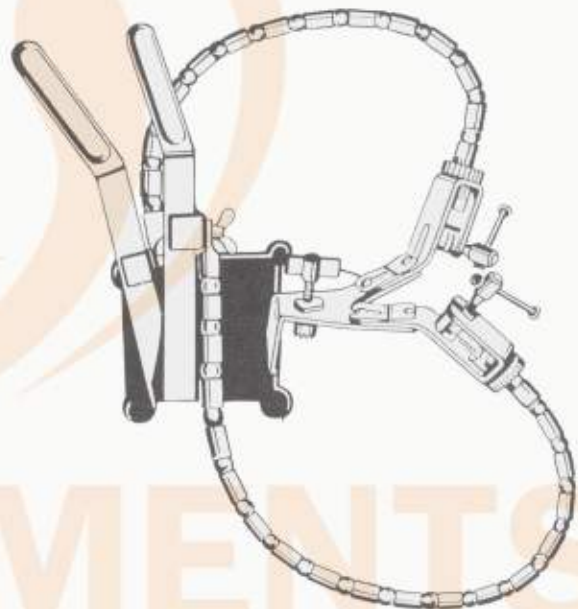

LEYLA
Self-Retaining Brain Retractor
with 2 flexible arms, complete consisting of
11-010-00
11-011-00
11-012-00

HAND DRILLS

Handbohrapparate Perforadores a mano
Perforateurs a main Perforatori a mano



HUDSON
11-015-00
Ø 9 mm



HUDSON
11-016-00
Ø 14 mm



HUDSON
11-017-00
Ø 16 mm



HUDSON
11-018-00
Ø 22 mm



ADSON
11-019-00
Ø 15 mm



Mc KENZIE
11-020-00
Ø 13 mm



CUSHING
11-021-00
Ø 14 mm



11-022-00
Ø 2 mm



GALT

- 11-023-00 Ø 12,5 mm
- 11-024-00 Ø 16 mm
- 11-025-00 Ø 19 mm

INSTRUMENTS

CERVICAL TRACTION TONGS

Schadelhalter

Pinces de traction Cranienne

Pinzas de traccion cranial

Pinze per trazione craniale



CRUTCHFIELD
 11-026-00
 Small size

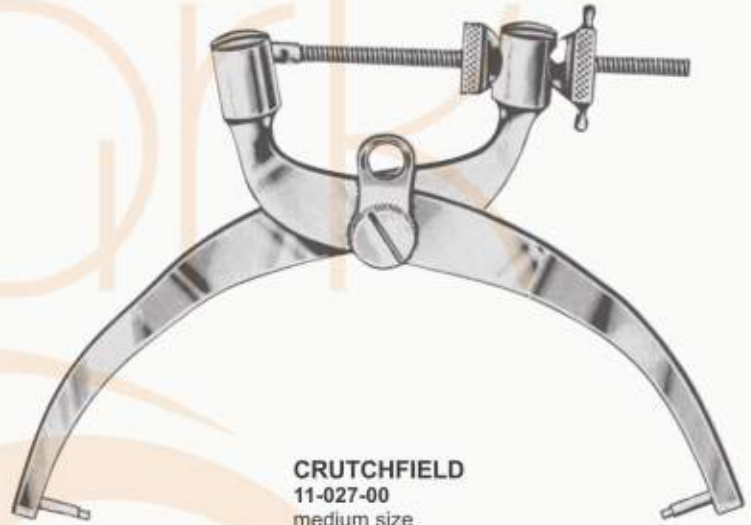

CRUTCHFIELD
 11-027-00
 medium size



11-028-00 Drill points
 11-029-00



CRUTCHFIELD
 11-030-00
 Large size

INSTRUMENTS

LAMINECTOMY PUNCHES

INSTRUMENTS

Laminektomiestanzen

Pinces emporte-pieces a laminectomie

Pinzas cortantes para laminectomia

Pinze taglianti per laminectomia



LAMINECTOMY PUNCHES

INSTRUMENTS

Laminektomiestanzen



Pinces emporte-pieces a laminectomie

Pinzas cortantes para laminectomia

Pinze taglienti per laminectomia



SPURLING

	11-042-150	15 cm 4 x 10 mm
	11-043-180	18 cm 4 x 10 mm
	11-044-200	20 cm 4 x 10 mm
	Straight	





SCHLESINGER

			$\frac{1}{4}$
11-045-150	11-046-150	11-047-150	
15 cm Straight 2 x 10 mm Serrated	15 cm Straight 3 x 10 mm Serrated	15 cm Straight 4 x 10 mm Serrated	



SCHLESINGER

		Straight		
Shaft	130 mm	150 mm	180 mm	
Bite 2 x 10 mm	11-048-00	11-051-00	11-054-00	
Bite 3 x 10 mm	11-049-00	11-052-00	11-055-00	
Bite 4 x 10 mm	11-050-00	11-053-00	11-056-00	

LAMINECTOMY PUNCHES

INSTRUMENTS

Laminektomiestanzen

Pinces emporte-pieces a laminectomie

Pinzas cortantes para laminectomia

Pinze taglianti per laminectomia

 2.0 mm
  3.0 mm
  3.5 mm



90°
 Up-cutting
 Shaft 140 mm
 Bite 2.0 mm **11-057-00**
 Bite 3.0 mm **11-058-00**
 Bite 3.5 mm **11-059-00**



90°
 Down-cutting
 Shaft 140 mm
 Bite 2.0 mm **11-060-00**
 Bite 3.0 mm **11-061-00**
 Bite 3.5 mm **11-062-00**



HAJEK-KOFLER



90 mm, 3 1/2"



KERRISON

11-063-00 4.5 mm
11-064-00 5.2 mm
 90°
 upwards cutting



 1.0 mm
 2.5 mm
 4.0 mm



CITELLI

11-065-00 1.0 mm
11-066-00 2.5 mm
11-067-00 4.0 mm

INSTRUMENTS

LAMINECTOMY PUNCHES

Laminektomiestanzen

Pinces emporte-pieces a laminectomie

Pinzas cortantes para laminectomia

Pinze taglianti per laminectomia



LOVE-KERRISON
LAMINECTOMY PUNCH



Forward 90° Regular Footplate

□	2 mm bite forward	
	11-068-00	150 mm
	11-069-00	200 mm

□	3 mm bite forward	
	11-070-00	150 mm
	11-071-00	200 mm

□	4 mm bite forward	
	11-072-00	150 mm
	11-073-00	200 mm

□	5 mm bite forward	
	11-074-00	150 mm
	11-075-00	200 mm

□	6 mm bite forward	
	11-076-00	150 mm
	11-077-00	200 mm



Up 40° Regular footplate

□	2 mm bite up	
	11-078-00	150 mm
	11-079-00	200 mm

□	3 mm bite up	
	11-080-00	150 mm
	11-081-00	200 mm

□	4 mm bite up	
	11-082-00	150 mm
	11-083-00	200 mm

□	5 mm bite up	
	11-084-00	150 mm
	11-085-00	200 mm

□	6 mm bite up	
	11-086-00	200 mm



Down 90° Regular footplate

□	3 mm bite down	
	11-087-00	150 mm
	11-088-00	200 mm

□	4 mm bite down	
	11-089-00	150 mm
	11-090-00	200 mm

□	5 mm bite down	
	11-091-00	150 mm
	11-092-00	200 mm

LAMINECTOMY PUNCHES

Laminektomiestanzen

Pinces emporte-pieces a laminectomie

Pinzas cortantes para laminectomia

Pinze taglianti per laminectomia



KERRISON PUNCH



Forward 90°

□	1 mm bite forward	
	11-093-00	150 mm
	11-094-00	180 mm
	11-095-00	200 mm

□	2 mm bite forward	
	11-096-00	150 mm
	11-097-00	180 mm
	11-098-00	200 mm

□	3 mm bite forward	
	11-099-00	150 mm
	11-100-00	180 mm
	11-101-00	200 mm

□	4 mm bite forward	
	11-102-00	150 mm
	11-103-00	180 mm
	11-104-00	200 mm

□	5 mm bite forward	
	11-105-00	150 mm
	11-106-00	180 mm
	11-107-00	200 mm



Up 40°

□	1 mm bite up	
	11-108-00	180 mm

□	2 mm bite up	
	11-109-00	180 mm

□	3 mm bite up	
	11-110-00	180 mm

□	4 mm bite up	
	11-111-00	180 mm

□	5 mm bite up	
	11-112-00	180 mm



Down 90°

□	1 mm bite down	
	11-113-00	180 mm

□	2 mm bite down	
	11-114-00	180 mm

□	3 mm bite down	
	11-115-00	180 mm

□	4 mm bite down	
	11-116-00	180 mm

□	5 mm bite down	
	11-117-00	180 mm

LAMINECTOMY PUNCHES

Laminektomiestanzen

Pinces emporte-pieces a laminectomie

Pinzas cortantes para laminectomia

Pinze taglianti per laminectomia

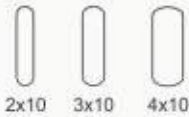

Straight Shaft	130 mm	180 mm
Bite 2 x 10 mm	11-118-00	11-121-00
Bite 3 x 10 mm	11-119-00	11-122-00
Bite 4 x 10 mm	11-120-00	11-123-00



Angled - up Shaft	130 mm	180 mm
Bite 2 x 10 mm	11-124-00	11-127-00
Bite 3 x 10 mm	11-125-00	11-128-00
Bite 4 x 10 mm	11-126-00	11-129-00



Angled - down Shaft	130 mm	180 mm
Bite 2 x 10 mm	11-130-00	11-133-00
Bite 3 x 10 mm	11-131-00	11-134-00
Bite 4 x 10 mm	11-132-00	11-135-00



**CUSHING
LOVE - GRUENWALD
SPURLING**



Straight Shaft	180 mm
Bite 2 x 10 mm	11-136-00
Bite 3 x 10 mm	11-137-00
Bite 4 x 10 mm	11-138-00



Angled - up Shaft	180 mm
Bite 2 x 10 mm	11-139-00
Bite 3 x 10 mm	11-140-00
Bite 4 x 10 mm	11-141-00



Angled - down Shaft	180 mm
Bite 2 x 10 mm	11-142-00
Bite 3 x 10 mm	11-143-00
Bite 4 x 10 mm	11-144-00



FERRIS - SMITH

LAMINECTOMY PUNCHES

Laminektomiestanzen

Pinces emporte-pieces a laminectomie

Pinzas cortantes para laminectomia

Pinze taglianti per laminectomia

4 mm
5 mm
6 mm

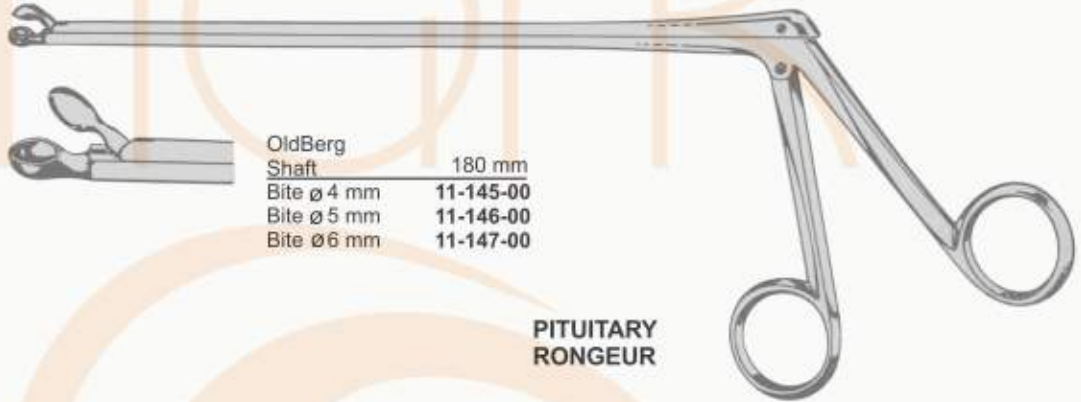

11-148-00
3.0 mm

11-149-00
3.6 mm

11-150-00
4.2 mm

11-151-00
4.8 mm

11-152-00
5.8 mm



INSTRUMENTS

LAMINECTOMY PUNCHES

INSTRUMENTS

Laminektomiestanzen

Pinces emporte-pieces a laminectomie

Pinzas cortantes para laminectomia

Pinze taglianti per laminectomia



Working length 14 mm

MICRO GRASPING FORCEPS

11-153-00
serrated, straight



MICRO ALLIGATOR SCISSORS

11-154-00
straight



11-155-00
Ø1.0 mm
Straight



11-156-00
Ø2.0 mm
Straight



11-157-00
Ø3.0 mm
Straight



MIRCO CUP FORCEPS



11-158-00
Ø1.0 mm
angled up



11-159-00
Ø2.0 mm
curved to right



11-160-00
Ø3.0 mm
curved to left



11-161-180
Grasping Forceps
Ø3 mm



11-162-180
Cup Forceps
Ø2 mm



11-163-180
Alligator Scissors
Ø2 mm



MICRO ALLIGATOR FORCEPS

with tubular shaft 18 cm

NERVE HOOK - DURA HOOKS

Nervenhaken - Durahaken

Crochets a nerfs - Crochets pour duremers

Ganchos para nervios - Ganchos para duramadre

Uncini per nervi - Uncini per duramadre



SCOVILLE
 11-164-300
 30 cm



SCOVILLE
 11-165-300
 30 cm



SCOVILLE
 11-166-300
 30 cm



DAVIS
 11-167-190
 4 mm, 19 cm



SACHS
 11-168-200
 3 mm, 20 cm



SACHS
 11-169-200
 6 mm, 20 cm



FRAZIER
 11-170-125
 12.5 cm



GILLIES
 19 cm



11-171-190
 Small



11-172-190
 large



11-173-130
 Straight
 13 cm



LAHEY CLINIC
 11-174-130
 13 cm



SACHS
 11-175-185
 18.5 cm



11-176-160
 16 cm



TOENNIS
 11-177-150
 15 cm



DURA TWIST HOOK
 11-178-140 14 cm

DURA DISSECTORS

Dura-Dissektoren
Decolleurs duremere

Disectores de duramadre
Dissetori per duramadre

Penfield



11-179-180
18 cm
Straight



11-180-200
20 cm
Straight



11-181-200
20 cm
Straight



11-182-220
22 cm
Straight



11-183-290
29 cm
Straight



DAVIS
11-184-245
24.5 cm



TONNIS
11-185-240 24 cm
11-186-240 24 cm



11-185-240 **11-186-240**



TONNIS
11-187-240
24 cm



Mc KENZIE
11-188-150
15 cm



Mc KENZIE
11-189-180
18 cm



RANEY
11-190-160
16 cm



ADSON
11-191-150
15 cm
Drill Guide and
Dura Protector

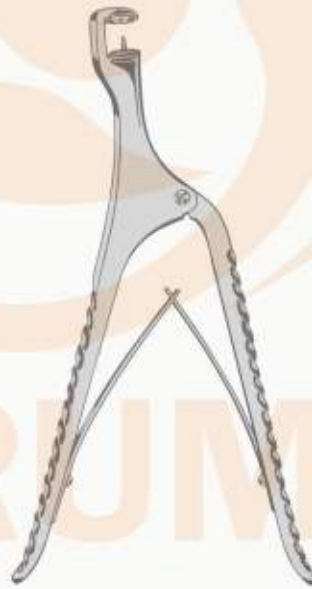

CONE
11-192-200 20 cm
11-193-230 23 cm
Skull Punch



DEVIBISS
11-194-210
21 cm
complete with 1 small and
1 large blade



INGE
11-195-160
 16 cm
 Small pattern

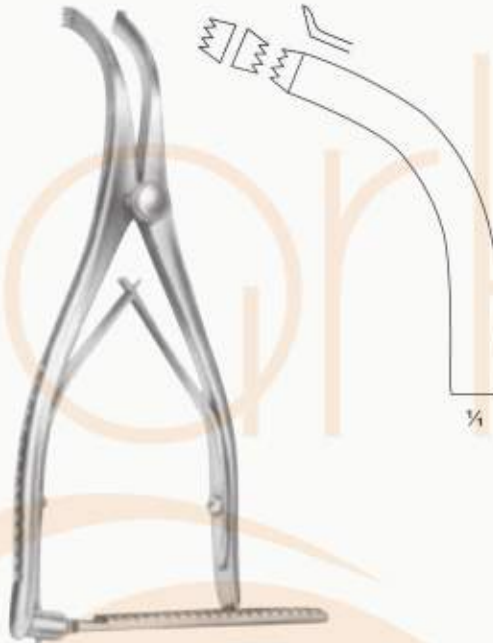

INGE
11-196-170
 17 cm



INGE, 26 cm
11-197-260 Jaw width 5 mm
11-198-260 Jaw width 10 mm
 large pattern



CLOWARD
11-199-130
 13 cm



LUMBAR LAMINA SPREADER
11-200-00
 arm length: 87.5 mm
 spread: 37.5 mm



CLOWARD
11-201-160
 16 cm



11-202-140
 14 cm

NERVE HOOK - DURA HOOKS

Nervenhooken - Durahaken

Crochets a nerfs - Crochets pour duremers

Ganchos para nervios - Ganchos para duramadre

Uncini per nervi - Uncini per duramadre



LOVE NERVE

21 cm
7 mm width x 5 mm depth

- A 11-203-210 Straight blade
- B 11-204-210 blade angled 45°degrees
- C 11-205-210 blade angled 90°degrees

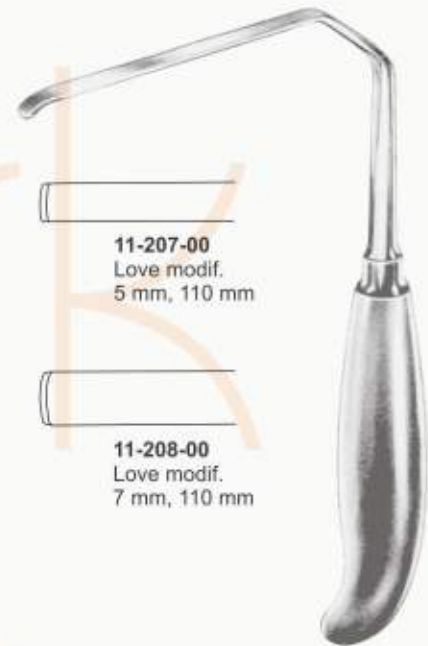

11-207-00
Love modif.
5 mm, 110 mm

11-208-00
Love modif.
7 mm, 110 mm

LOVE MODIF.
11-206-00
4 mm, 100 mm



HOLSHER NERVE RETRACTOR

11-209-230 23 cm angled 7 mm blade
11-210-230 9 mm blade

NERVE ROOT RETRACTOR

11-211-00 6 mm blade
11-212-00 9 mm blade
Offset 225 mm

SCOVILLE NERVE ROOT RETRACTOR

11-213-230 8 mm blade
11-214-230 13 mm blade
23 cm angled

SECTION - 12

EAR NOSE THROAT SURGERY



EAR SPECULUM

Ohrspekula Espéculos auriculares
Speculums auriculaires Spécoli auricolari

2.0 3.0 3.5 4.0 4.5 5.0 6.0 6.5 7.0 7.5 mm



BOUCHERON

12-001-01 Set of 4
12-002-02 4.2 mm
12-003-03 5.2 mm
12-004-04 6.2 mm
12-005-05 7.2 mm



PLOITZER

12-006-01 Set of 3
12-007-02 2 mm
12-008-03 3 mm
12-009-04 4 mm



HARTMANN

12-010-01 3.0 mm
12-011-02 4.0 mm
12-012-03 5.0 mm
12-013-04 6.0 mm
12-014-05 7.0 mm



TOYNBEE

12-015-01 set of 3 sizes
12-016-02 4.0 mm
12-017-03 5.5 mm
12-018-04 7.0 mm



HARTMANN

for children
12-019-01 Set of 3
12-020-02 2 mm
12-021-03 3.2 mm
12-022-04 3.5 mm
12-023-05 5 mm



GRUBER AURAL SPECULA

Black finish, diam, 38 mm
12-024-01 Set of 4
12-025-02 3 mm
12-026-03 4 mm
12-027-04 5 mm
12-028-05 7 mm



ROSEN

Black finish, slotted round ends 35 mm
12-029-01 Set of 4
12-030-02 3 mm
12-031-03 4 mm
12-032-04 5 mm
12-033-05 7 mm



ROSEN

slotted round ends
Black finish, 35 mm
12-034-01 Set of 4
12-035-02 4 mm
12-036-03 5 mm
12-037-04 6 mm
12-038-05 7 mm

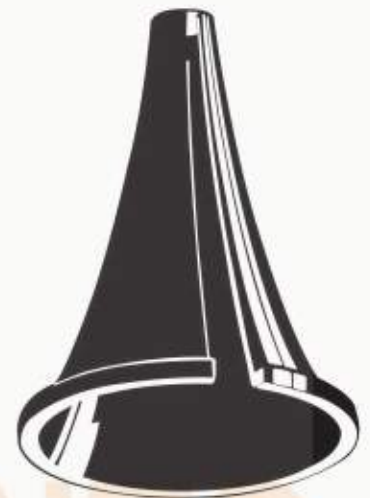

TUMARKIN

Tapered Slot
12-039-01 Size Set of 8
12-040-02 0 4.5 mm
12-041-03 1 6.5 mm
12-042-04 2 7.0 mm
12-043-05 3 7.5 mm
12-044-06 4 8.0 mm
12-045-07 5 8.5 mm
12-046-08 6 9.0 mm
12-047-09 7 11. mm

EAR SPECULUM

Ohrspekula *Espéculos auriculares*
Speculums auriculares *Spécoli auricolari*



12-048-01

12-052-05
Rubber Bulb with rubber tube and connection cone



12-049-02
Ear Speculum, Ø 5 mm



12-050-03
Ear Speculum, Ø 6 mm



12-051-04
Ear Speculum, Ø 7 mm

SIEGLE
Single Part:



POLITZER
12-053-01
Air Douche, with metal mount



Metal Nasal Tips
12-054-01 Ø 18 mm
12-055-02 Ø 21 mm
12-056-03 Ø 23 mm



12-057-01
Metal Connector, eustachian catheter to Politzer air douche

- 12-058-01 Ø 2 mm ○
- 12-059-02 Ø 2,5 mm ○
- 12-060-03 Ø 3 mm ○
- 12-061-04 Ø 4 mm ○
- 12-062-05 Ø 5 mm ○

HARTMANN
Eustachian Catheters



REINER
12-063-000
Tip Only



REINER
12-064-000
Tip Only



12-065-000
Shield

- 12-066-000 50ML Complete
- 12-067-000 75ML Complete
- 75ML Complete 150ML Complete
- With Tip & Shield



TUNING FORKS

Stimmgabeln Diapasones
Diapasons Diapasoni



12-068-064
C 64



12-069-128
C 128



12-070-256
C 256



12-071-512
C 512



12-072-1024
C 1024



12-073-2048
C 2048



12-074-4096
C 4096



12-075-000 = Set 5

- 12-069-0128 C 0128
- 12-070-0256 C 0256
- 12-071-0512 C 0512
- 12-072-1024 C 1024
- 12-073-2048 C 2048



HARTMANN



LUCAE



HARTMANN-FRENCH



HARTMANN
12-093-000 = Set 6

- 12-076-128 128C
- 12-077-256 256C¹
- 12-078-512 512C²
- 12-079-1024 1024C³
- 12-080-2048 2048C⁴
- 12-081-4096 4096C⁵

LUCAE
12-094-000 = Set 6

- 12-082-128 128C
- 12-083-256 256C¹
- 12-084-512 512C²
- 12-085-1024 1024C³
- 12-086-2048 2048C⁴
- 12-087-4096 4096C⁵

HARTMANN-FRENCH
12-095-000 = Set 7

- 12-088-016 16C²
- 12-089-032 32C²
- 12-090-064 64C
- 12-091-128 128C
- 12-092-256 256C¹

C	128 c	12-076-128	12-082-128	12-091-128
C ¹	256 c ¹	12-077-256	12-083-256	12-092-256
C ²	512 c ²	12-078-512	12-084-512	
C ³	1024 c ³	12-079-1024	12-085-1024	
C ⁴	2048 c ⁴	12-080-2048	12-086-2048	
C ⁵	4096 c ⁵	12-081-4096	12-087-4096	

EAR LOOPS - HOOKS

Ohrschlingen - Häkchen
Anses - crochets auriculaires

Asas - ganchos auriculares
Anse - uncini auricolari

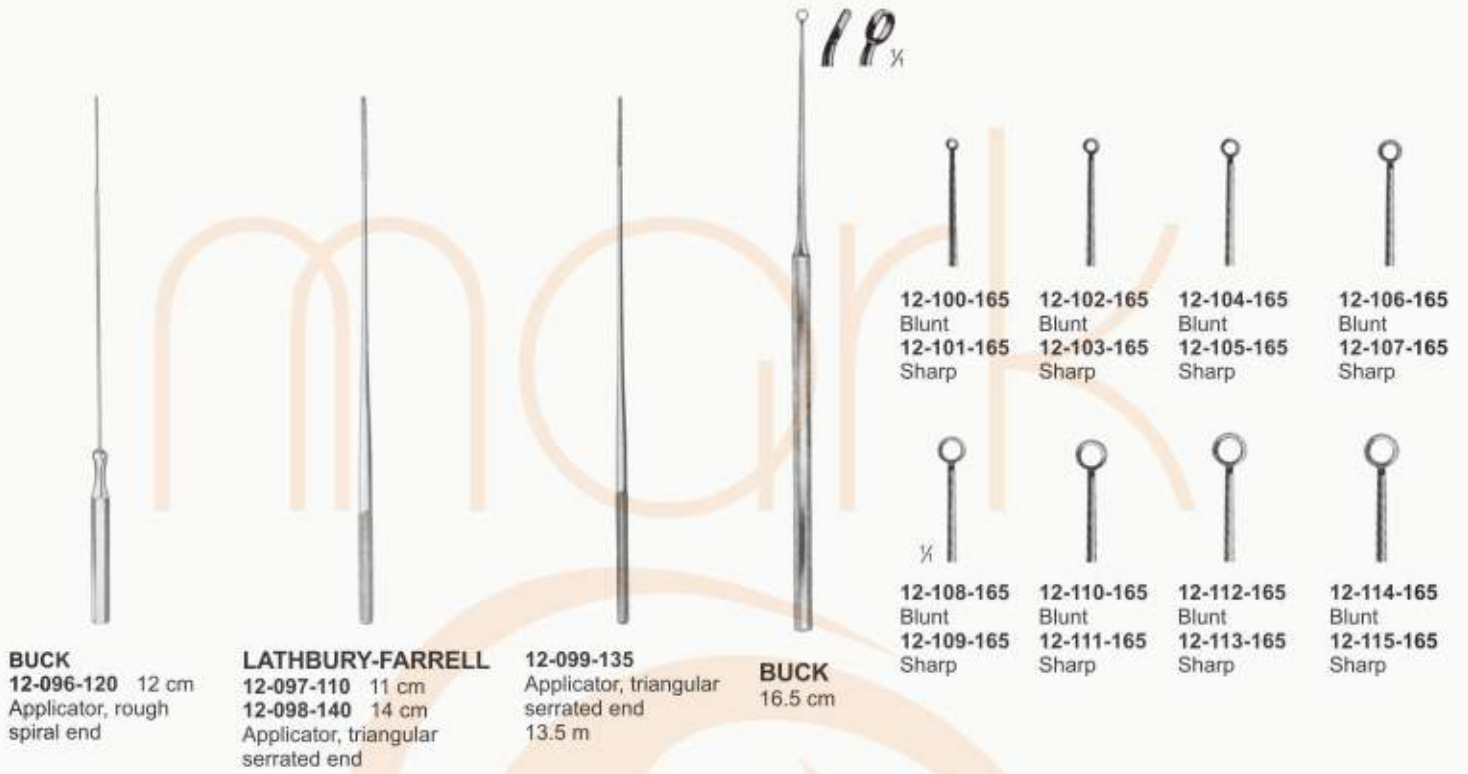

EAR POLYPUS FORCEPS

INSTRUMENTS

Ohrpolypenzangen

Pinzas para pólipos auriculares

Pinces pour polypes auriculaires

Pinze per polipi auricolari



PERIOSTEAL ELEVATORS, SEPTUM ELEVATORS

Periostelevatorien, Septumelevatorien

Legras para periostio, Elevadores para el tabique nasal

Elevateurs pour la périoste, Elevateurs pour la cloison nasale

Elevatori per il periostio, Elevatori per setto



SHEA
12-148-160
16 cm
1.5 x 2.5 mm



SHEA
12-149-160
16 cm
1.5 x 2.5 mm



HOUSE
12-150-150 1.0 + 1.2 mm
12-151-150 1.5 + 1.8 mm
15 cm



HOUSE
12-152-150 1.0 + 1.2 mm
12-153-150 1.5 + 1.8 mm
15 cm



12-154-170
17 cm
small



12-155-170
17 cm
large



BARTH
12-156-180
18 cm



JANDEN
12-157-150
15 cm



LEMPERT
17 cm



12-158-170
2 mm



12-159-170
3 mm



12-160-170
4 mm



12-161-170
5 mm

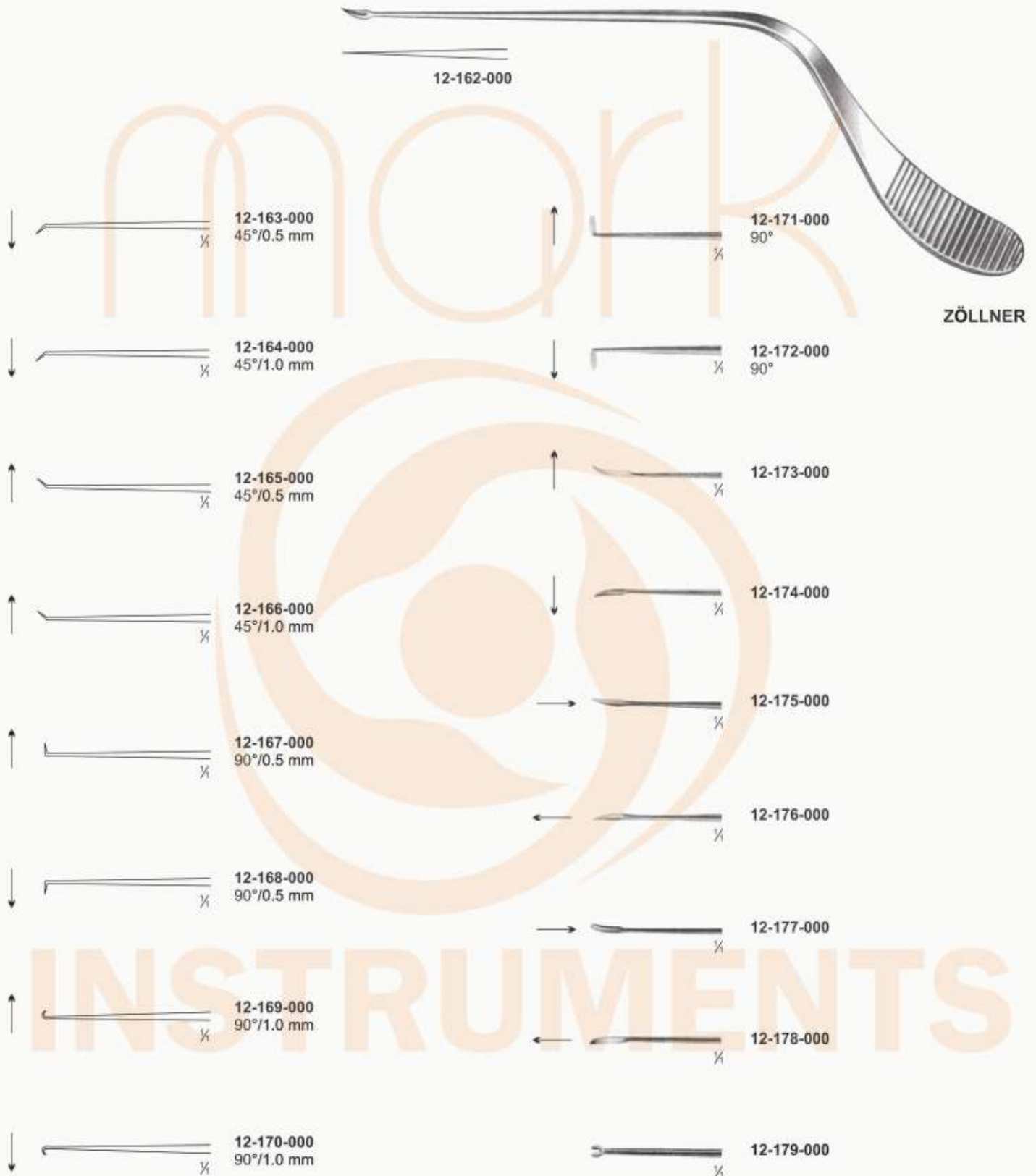

EAR FORCEPS

Ohrzängchen Pinzas auriculares
Pincas auriculaires Pinze auricolari



HARTMANN-WULLSTEIN
12-180-000



HARTMANN-WULLSTEIN
12-181-000



HARTMANN
12-182-085 8.5 cm
12-183-140 14.0 cm



HARTMANN
12-184-000
12-185-000



HARTMANN-NOYES
12-186-000



DUCKBILL
12-187-000



WEINGÄRTNER
12-188-000



HARTMANN
12-189-000 = 2.0 mm
12-190-000 = 2.5 mm
12-191-000 = 3.0 mm



HARTMANN
12-192-000 = 2.0 mm
12-193-000 = 2.5 mm
12-194-000 = 3.0 mm



STRÜMPEL
12-195-000



HARTMAN
12-196-000



HARTMANN
12-197-000



HARTMANN-HOFFMANN
12-198-000

INSTRUMENTS

TONSIL INSTRUMENTS

Tonsillieninstrumente
Instruments pour amygdales

Instrumentos para amígdalas
Strumenti per tonsille



TROELTSCH
12-199-110
11 cm



TROELTSCH
12-200-130
13 cm



TROELTSCH
12-201-120
12 cm



LUCAE
12-202-160
16 cm



JANSEN
12-203-200
20 cm



HARTMANN
12-204-135
Ear Tampon Forceps
13.5 cm



TILLEY
12-205-140
Ear Tampon Forceps
extra fine pattern
14 cm

NASAL CUTTING FORCEPS

Scharfe Nasenzangen Pinzas nasales cortantes
Pincès coupantes pour le nez Pinze taglianti per naso



CRAIG
12-206-170
17 cm



CRAIG-DOMNICK



BRUENINGS

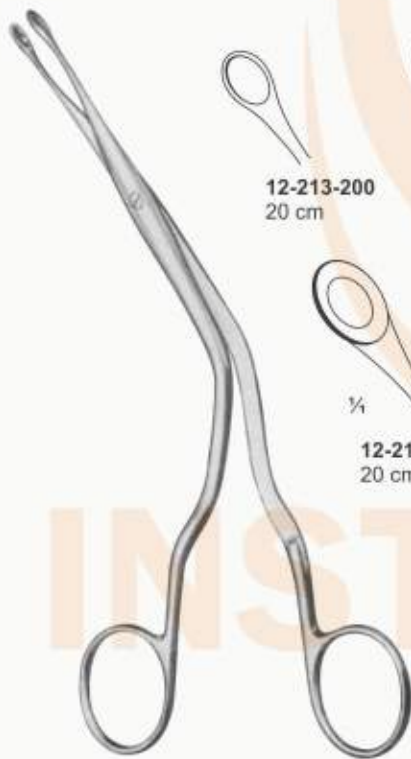

LUC

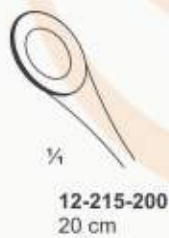

KNIGHT
12-217-180
18 cm



HEYMANN



TONSIL POLYPUS AND SEPTUM FORCEPS

Nasenpolypenzangen-Septumzangen
Pinces à polypes et la cloison nasale

Pinzas para pólipos y el tabique nasal
Pinze per polipi e setto nasale



HARTMANN
 12-221-160
 16 cm
 12-222-200
 20 cm



HEYMANN-KNIGHT
 12-223-180
 18 cm



LUBET-BARBON
 12-224-200
 20 cm



KILLIAN
 12-225-170
 17 cm



WEST



12-226-200
 20 cm

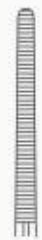

12-227-200
 20 cm

INSTRUMENTS

PARACENTESIS NEEDLES

Parazentesenadein Agujas para paracentesis
Aiguilles de paracentèse Aghi per paracentesi



POLITZER
12-228-160
Myringotome
16 cm



LUCAE
12-229-160
for children, 16 cm
12-230-190
for adults, 19 cm
Tympanum Perforators, bayonet-shaped
12-231-180
for children, 18 cm
Tympanum Perforator, bayonet-shaped,
handle 90 angled to the lancet



AGNEW
12-232-190
Tympanum Perforator,
angular
19 cm



POLITZER
12-233-160
Tympanum Perforator,
angular
16 cm



PARTSCH
12-234-140 3 mm
12-235-140 4 mm
12-236-140 5 mm
12-237-140 6 mm
14 cm



PARTSCH
12-238-140 3 mm
12-239-140 4 mm
12-240-140 5 mm
12-241-140 6 mm
14 cm



JANSEN
12-242-140 4 mm
12-243-140 6 mm
12-244-140 8 mm
12-245-140 10 mm
12-246-140 12 mm
14 cm



JANSEN
12-247-140 4 mm
12-248-140 6 mm
12-249-140 8 mm
12-250-140 10 mm
12-251-140 12 mm
14 cm



JANSEN
12-252-140 4 mm
12-253-140 6 mm
12-254-140 8 mm
12-255-140 10 mm
12-256-140 12 mm
14 cm

EAR FORCEPS

INSTRUMENTS

Ohrzängchen Pinzas auriculares
 Pincas auriculaires Pinze auricolari



12-257-080
Straight

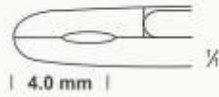

12-258-080
Curved right



12-259-080
Curved left

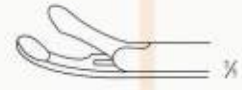

12-260-080
Curved up



12-261-080
Curved down



12-262-080
Micro scissor
straight, sharp / sharp



BELLUCCI
12-263-080
Micro scissor
curved up, blunt / blunt



BELLUCCI
12-265-080
Micro scissor
curved to the right,
sharp / sharp



BELLUCCI
12-264-080
Micro scissor
curved to the left,
sharp / sharp



BELLUCCI
12-266-080
Micro scissor
horizontal cutting

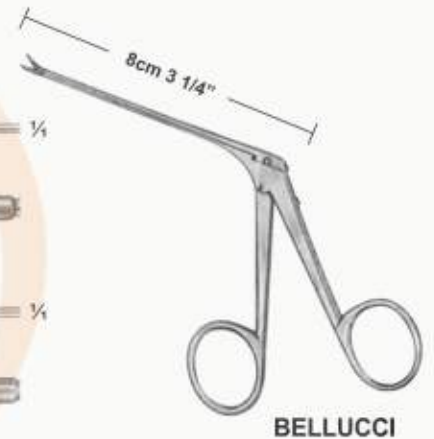

BELLUCCI

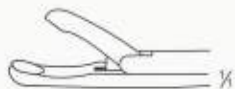

CRURA-NIPPER
12-267-080

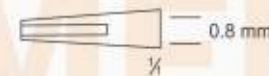
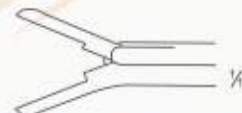

McGEE
12-268-080

EAR FORCEPS

Ohrzängchen Pinzas auriculares
 Pincas auriculaires Pinze auricolari

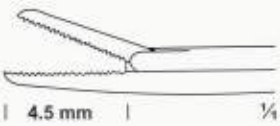

12-272-080
 8 cm
 Straight-Serrated
 4.5 x 0.8 mm

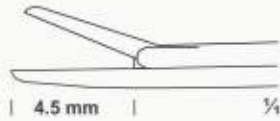

12-273-080
 8 cm
 Straight-Serrated
 4.5 x 0.8 mm

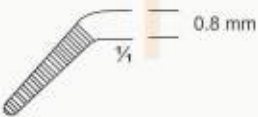

12-274-000

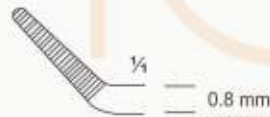

12-275-000



12-276-000



12-277-000

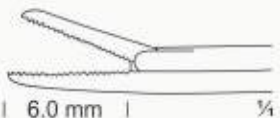

12-278-080
 8 cm
 Straight-Serrated
 6 x 0.8 mm

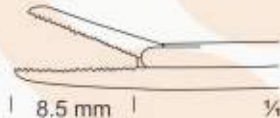

12-279-080
 8 cm
 Straight-Serrated
 8.5 x 1.8 mm

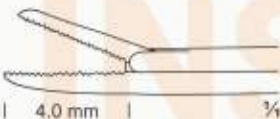

12-280-080
 8 cm
 Straight-Serrated
 4 x 0.6 mm

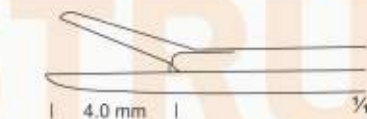

12-281-000



12-269-075
 7.5 cm
 With Stylus
 1.0 mm

12-270-075
 7.5 cm
 With Stylus
 1.5 mm

12-271-075
 7.5 cm
 With Stylus
 2.0 mm

MICRO-EAR FORCEPS

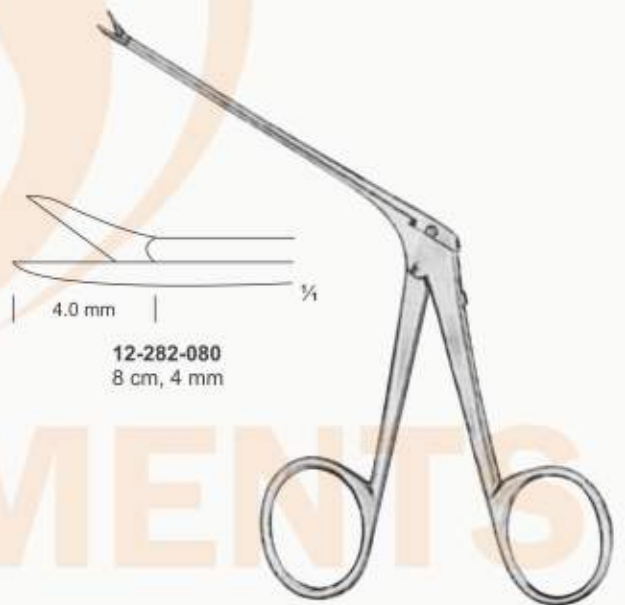

12-282-080
 8 cm, 4 mm

MICRO-EAR SCISSORS

MICRO EAR SCISSORS

INSTRUMENTS

Mikro-Ohrscheren

Micro-tijeras para oídos

Micro ciseaux auriculaires

Micro-forbici auricolari

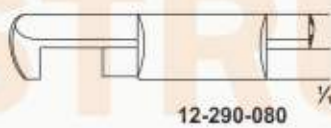
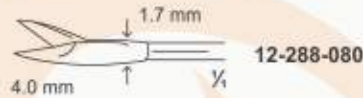
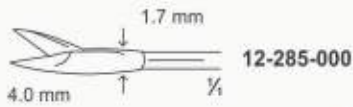
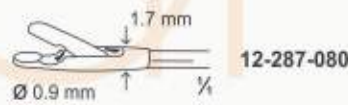
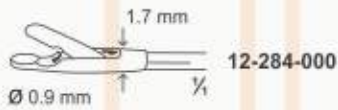
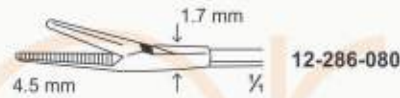

INSTRUMENTS

EAR POLYPUS SNARES

Ohrpolypenschnürer

Polipótomos auriculares

Serre noeuds auriculaires

Serranodi auricolari



HEYMANN
12-291-200
 Nasal Scissors
 20 cm

KIRSTEIN
12-292-180
 Nasal Scissors,
 blades serrated
 18 cm

OLIVECRONE
12-293-225
 Nasal Scissors,
 22.5 cm



SNARE WIRE
12-294-001
 in coils of 10 meters
 Ø 0,3 mm

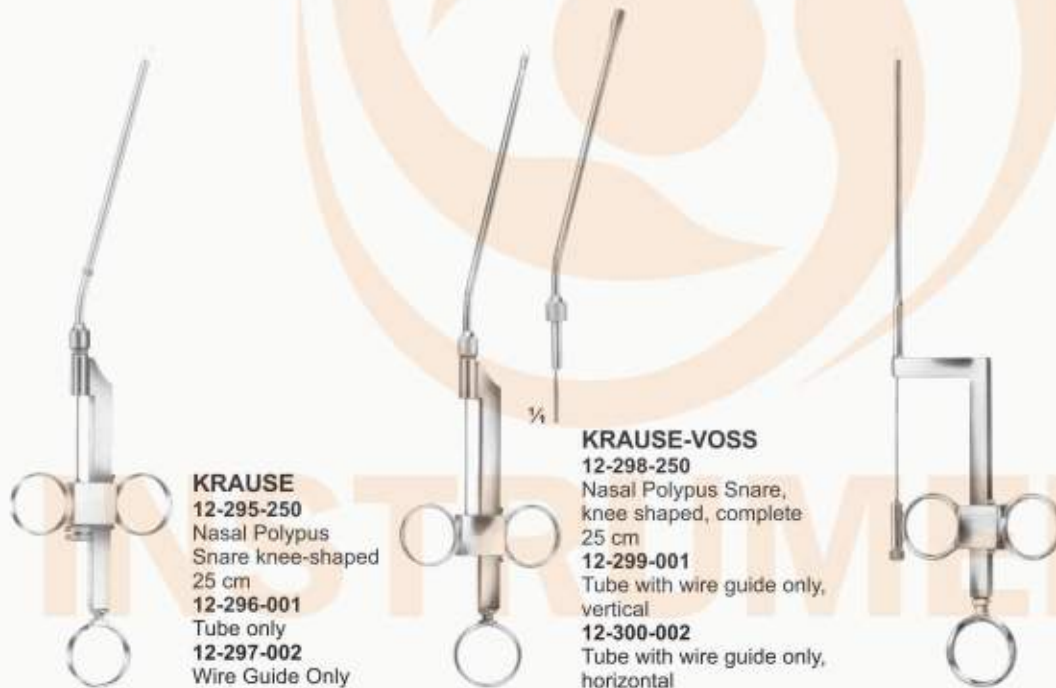

KRAUSE
12-295-250
 Nasal Polypus
 Snare knee-shaped
 25 cm
12-296-001
 Tube only
12-297-002
 Wire Guide Only

KRAUSE-VOSS
12-298-250
 Nasal Polypus Snare,
 knee shaped, complete
 25 cm
12-299-001
 Tube with wire guide only,
 vertical
12-300-002
 Tube with wire guide only,
 horizontal



WILDE
12-301-250
 Nasal Polypus Snare,
 bayonet-shaped
 25 cm

WIRE LOOPS
12-302-001
 package of 100 pieces,
 Sales unit: PH=100 pieces
 Ø 0,3 mm

MICRO EAR CHISELS AND HAMMERS

MikroOhrmeissel und Hämmer

Micro cincels y martillos para orejas

Micro burins et marteaux auriculaires

Micro scalpelli e martelli per orecchio

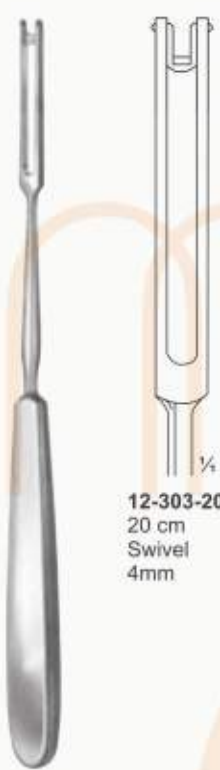

12-303-200
 20 cm
 Swivel
 4mm



4 mm



5 mm



1/4
 6 mm

BALLENGER

- 12-304-210 4 x 3 mm
- 12-305-210 5 x 4 mm
- 12-306-210 6 x 5 mm
- 21 cm
- Swivel Knife,
 bayonet-shaped

BALLENGER



JOSEPH
 12-307-170
 straight



JOSEPH
 12-308-170
 bayonet shaped
 right curved



JOSEPH
 12-309-170 bayonet
 shaped left curved,
 nasal saws
 17 cm



12-310-180
 Mallet, Septum Gouge, head with
 interchangeable nylon inserts,
 approx. 140 g, 18 cm
12-311-180
 Pair of interchangeable
 nylon inserts, for mallet



COTTLE
 12-312-190
 19 cm
 Mallet, 1 plain face
 1 convex face
 approx. 240 g

NASAL SPECULA

Nasenspekula Especulos nasales
Spéculums nasaux Specoli nasali



THUDICHUM
(Golfsmith)



12-313-065
6.5 cm



12-314-065
6.5 cm



1/4
12-315-065
6.5 cm



VOLTOLINI
(Duplay)



12-316-000



12-317-000



1/4
12-318-000



KILLIAN

12-319-130
13 cm, 35 mm



12-320-130
13 cm, 50mm



12-321-130
13 cm, 75mm



12-322-130
13 cm, 90 mm



With Fixing Screw



COTTLE
12-323-150
15 cm

NASAL SPECULA

Nasenspekula Especulos nasales
 Spéculums nasaux Specoli nasali



BECKMANN
 12-324-150
 15 cm



12-325-150
 15 cm

BECKMANN



12-326-150
 15cm

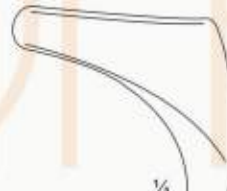

1/4
 12-327-150
 15 cm



VIENNA NASAL
 12-328-001 - Infant
 12-329-002 - Child
 12-330-003 - Adult



12-331-135
 13.5 cm



1/4
 12-332-135
 13.5 cm

TIECK-HALLE



1/4
 12-333-150
 15 cm

HARTMANN-HALLE



12-334-150
 15 cm



12-335-150
 15 cm



1/4
 12-336-150
 15 cm



HARTMANN



12-337-150
 15 cm



12-338-150
 15 cm

PERIOSTEAL ELEVATORS, SEPTUM ELEVATORS

INSTRUMENTS

Periostelevatorien, Septumelevatorien
Elevateurs pour la périoste, Elevateurs pour la cloison nasale

Legras para periostio, Elevadores para el tabique nasal
Elevatori per il periostio, Elevatori per setto



FREER
 12-339-155



BRUNINGS
 Septatome
 12-340-155
 15.5 cm



HALLE
 12-341-180
 3,3 mm
 18 cm



FREER
 12-342-190
 4 mm
 19 cm



FREER
 12-343-190
 4 mm
 19 cm



FREER
 12-344-190
 4 mm
 19 cm



FREER
 12-345-175
 4 mm
 17.5 cm

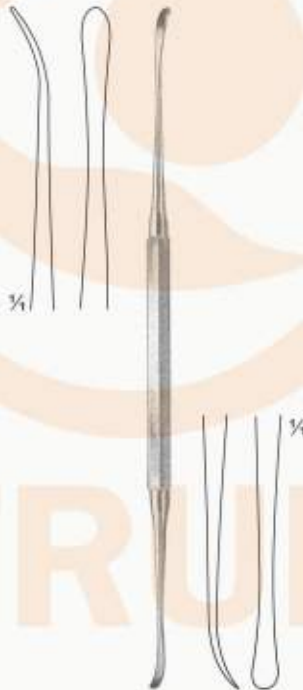

FREER
 12-346-185
 18.5 cm

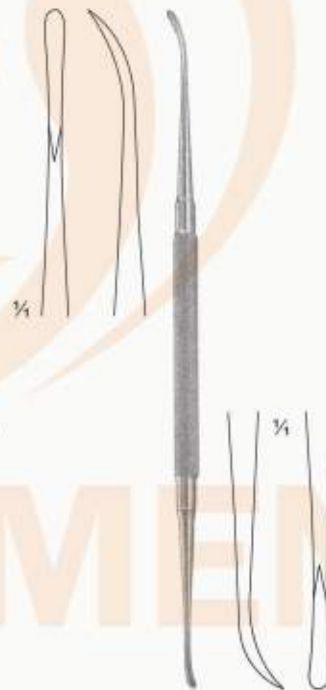

FREER-YASARGIL
 Dissector, sharp
 12-347-185
 18.5 cm

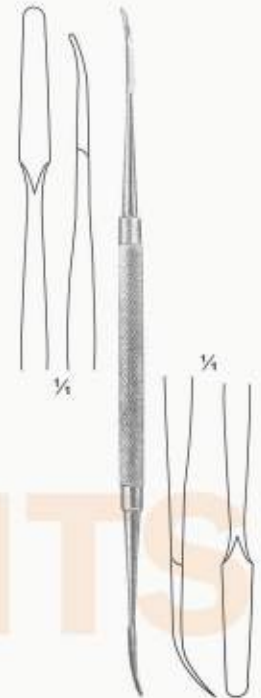

KILLIAN
 sharp / blunt
 12-348-180
 18 cm

SEPTUM ELEVATORS

INSTRUMENTS

Septumelevatorenien
 Elevateurs

Elevadores
 Elevatori



HILL
 12-349-220
 22 cm
 semi-sharp / blunt



MACDONALD
 12-350-190
 19 cm
 blunt / blunt

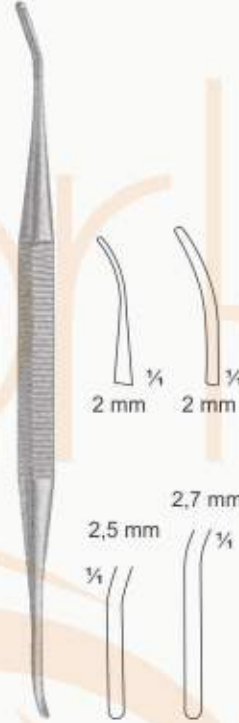

WATRON-CHEYNE
 12-351-190
 19 cm

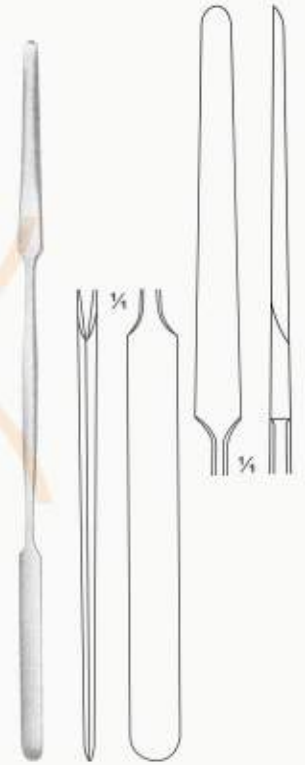

KILLIAN
 12-352-185
 18.5 cm
 sharp / blunt



**NEGUS SUCTION
 DISSECTOR**
 12-353-210
 21 cm, Ø 6 mm



**NEGUS
 suction dissector,**
 12-354-210
 21 cm, Ø 6 mm



HOWASTH
 12-355-215
 21.5 cm



FREER
 12-356-180
 180 cm

PERIOSTEAL ELEVATORS, SEPTUM ELEVATORS

INSTRUMENTS

Periostelevatori, Septumelevatori
 Elevateurs pour la périoste, Elevateurs pour la cloison nasale

Legras para periostio, Elevadores para el tabique nasal
 Elevatori per il periostio, Elevatori per setto



ST CLAIR THOMPSON
 12-357-160
 sharp / blunt
 16 cm



FREER
 12-358-160
 sharp / blunt
 straight
 16 cm



FREER
 12-359-160
 sharp / blunt
 Curved
 16 cm



PENNINGTON
 12-360-210
 21 cm



COTTLE
 12-361-200
 20 cm



COTTLE
 12-362-200
 20 cm

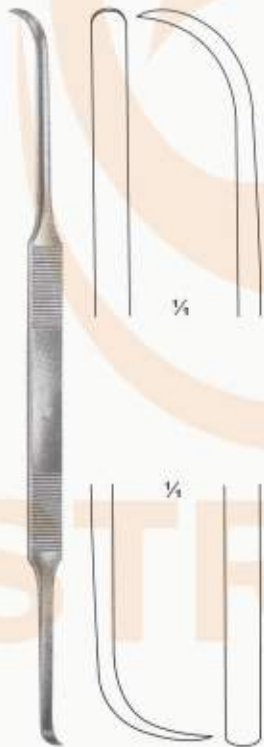

COTTLE
 12-363-200
 20 cm



COTTLE
 12-364-200
 curved, sharp
 20 cm



HALLE
 12-365-180
 blunt
 18 cm



FREER
 12-366-200
 sharp
 18 cm

PERIOSTEAL ELEVATORS, SEPTUM ELEVATORS

Periostelevatorien, Septumelevatorien

Elevateurs pour la périoste, Elevateurs pour la cloison nasale

Legras para periostio, Elevadores para el tabique nasal

Elevatori per il periostio, Elevatori per setto

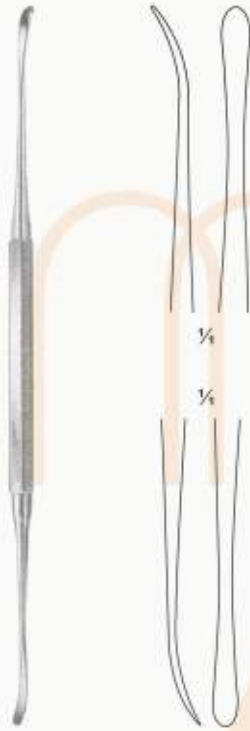

FREER
 sharp/blunt
 12-367-185
 18.5 cm



FREER YASARGIL
 sharp
 12-368-185
 18.5 cm



FREER YASARGIL
 sharp/blunt
 12-369-185
 18.5 cm



HOWARTH
 12-370-215
 21.5 cm

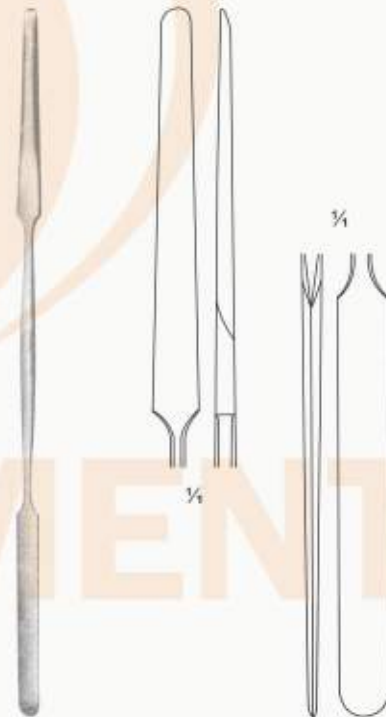

KILLIAN
 sharp/blunt
 12-371-215
 21.5 cm

INSTRUMENTS

HOOKLET & SKIN HOOKS

Wundhäkchen, Mikrohäkchen
 Ganchito, Micro Ganchitos

Crochet, Micro crochets
 Divaricatore, Micro Divaricatori

INSTRUMENTS



COTTLE-NEIVERT
 12-372-200
 20 cm



CONVERSE
 12-373-120
 12 cm



MASING
 12-374-200
 20 cm



COTTLE
 12-375-150
 15 cm



COTTLE
 12-376-150
 15 cm



JOSEPH
 12-377-160
 16 cm



JOSEPH
 16 cm



12-378-160
 2 mm



12-379-160
 5 mm



12-380-160
 7 mm



12-381-160
 10 mm



JOSEPH
 12-382-160
 16 cm



FOMON
 12-383-170
 17 cm



LANGE
 12-384-220
 22 cm



FOMON
 12-385-160
 16 cm



FREER
 12-386-150
 15 cm



COTTLE
 14 cm



12-387-140
 sharp/sharp



12-388-140
 blunt/blunt



12-389-140
 sharp/blunt



COTTLE
 12-390-001



KILNER
 12-391-001



COTTLE
 12-392-140
 14 cm

BONE CHISELS & GOUGES

Knochenmeißel
Ciseaux-burins, gouges

Cineles, gubias
ScalPELLI, sgorbi



1/2

FREER
12-393-160
16 cm
4 mm wide
straight



1/2

FREER
12-394-160
16 cm
4 mm wide
curved



1/2

FREER
12-395-150
15 cm
4 mm wide



1/2

BALLENGER
12-396-155
15.5 cm
6 mm wide



1/2

KILLIAN-CLAUS
12-397-170
17 cm
6 mm wide



1/2

KILLIAN
12-398-170
17 cm
6 mm wide



MASING
12-399-175
17.5 cm



MASING
12-400-175
17.5 cm



MASING
12-401-175
17.5 cm



MASING
12-402-175
17.5 cm

BONE CHISELS & GOUGES

Knochenmeißel
Ciseaux-burins, gouges

Cineles, gubias
Scalpelli, sgorbi



SILVER
12-403-180
18 cm



SILVER
12-404-180
18 cm



SILVER
12-405-180
18 cm



WALTER

12-406-180
180 cm



12-407-180
180 cm



NEIVERT
12-408-200
20 cm



ANDERSON-NEIVERT
12-409-200
20 cm



ANDERSON-NEIVERT
12-410-200
20 cm



CONVERSE

CONVERSE
12-411-190
19 cm



CONVERSE
12-412-190
19 cm



GILLIES
12-413-140
Osteotome
140 cm



12-414-140 5 mm
12-415-140 7 mm
12-416-140 9 mm

CHISELS, OSTEOTOMES FOR RHINOPLASTIC

Meißel zur Nasenplastik

Osteotomes, ciseaux-burins pour rhinoplastique

Cinceles para rinoplastica

Scalpelli per plastica nasale



COTTLE
12-417-180
18 cm



COTTLE
12-418-180
4 mm, 6 mm, 8 mm
10 mm, 12 mm
18 cm



COTTLE
12-424-180
4 mm, 7 mm
9 mm, 12 mm
18 cm



COTTLE
12-429-180
18 cm

12-419-180 4 mm
12-420-180 6 mm
12-421-180 8 mm
12-422-180 10 mm
12-423-180 12 mm

12-425-180 4 mm
12-426-180 7 mm
12-427-180 9 mm
12-428-180 12 mm



LAMBOTTE
12-430-125
4 mm, 4 mm, 6 mm, 8 mm,
10 mm, 12 mm, 15 mm
12.5 cm

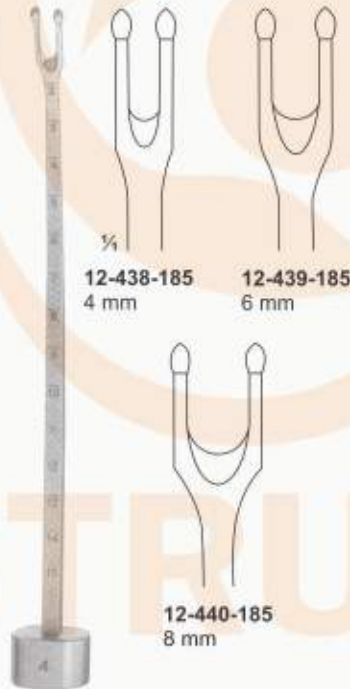

OSTEOTOMES
12-437-185
18.5 cm



CINELLI
12-441-160
10 mm, 12 mm
14 mm, 16 mm
16 cm

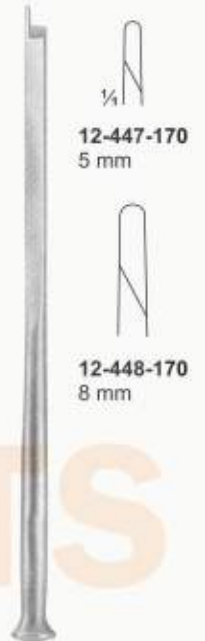

FOMON
12-446-170
5 mm, 8 mm
17 cm

12-431-125 4 mm
12-432-125 6 mm
12-433-125 8 mm
12-434-125 10 mm
12-435-125 12 mm
12-436-125 15 mm

12-438-185 4 mm
12-439-185 6 mm
12-440-185 8 mm

12-442-160 10 mm
12-443-160 12 mm
12-444-160 14 mm
12-445-160 16 mm

12-447-170 5 mm
12-448-170 8 mm

RASPS, FILES

Raspeln, Feilen
Rapes, Limes

Escofinas, limas
Raspe, lime

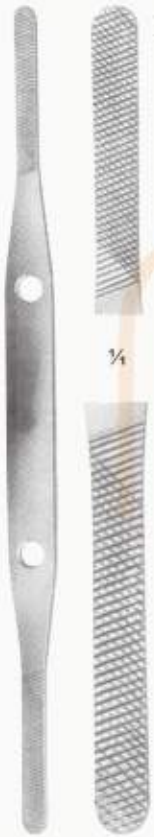

6,5 mm

¼

7,5 mm

FOMON File, fine / coarse
12-449-215
21.5 cm



6,5 mm

¼

¼

7,5 mm

FOMON Rasp fine coarse teeth
12-450-215
21.5 cm



7,5 mm

¼

JOSEPH
12-451-165
16.5 cm

9 mm

¼



With tungsten carbide inserts

12-452-205
Rasps, double ended, with tungsten carbide inserts
20.5 cm



12-453-205
12 Teeth 14



12-454-205
16 Teeth 20



12-455-205
24 Teeth 30



12-456-205
36 Teeth 44



12-457-205
52 Teeth 62



NASAL SAWS

Nasensägen
Scies nasales

Sirerras nasales
Seghe nasali



MILLER-COLBURN
19 cm

MILLER
12-463-185
18.5 cm

AUFRICHT
12-464-185
18.5 cm



12-465-180
18 cm
Large Serrations

LEWIS

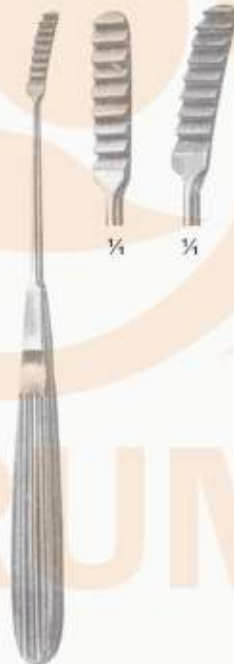

MALTZ
12-466-180 Straight
12-466-180 Curved
18 cm



MALTZ
12-467-180
18 cm

SEPTUM INSTRUMENTS

Septuminstrumente

instruments pour la cloison nasal

Instrumentos para el tabique nasal

Strumenti per il setto nasale



ASCH
 12-468-230
 23 cm



$\frac{1}{4}$
 12-469-210
 21 cm
 right



WALSHAM



12-470-210
 21 cm
 left



BOIES
 12-471-180
 18 cm



Cottle Bone



12-472-180
 Cottle Cartilage Crusher

SEPTUM FORCEPS

Septumzangen

Pinces pour la cloison nasale

Pinzas para el tabique nasal

Pinze per il setto nasale



12-473-190
19 cm
Double Action
5 x 15mm tip

JANSEN-MIDDLETON



12-474-190
19 cm
Double Action
4 x 20 mm tip

JANSEN-MIDDLETON



KILLIAN
12-475-200
20 cm

INSTRUMENTS

ANTRUM CURETTES

Antrumküretten Curetas para el antrum
Curettes d'antrum Curette per antrum



COAKLEY SINUS



COAKLEY SINUS



PRATT EHTMOID



12-485-220
22 cm

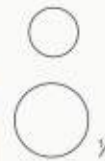

12-486-222
22.2 cm



FAULKNER EHTMOID

INSTRUMENTS

DERMAL PUNCHES



○
2mm
12-487-001

○
3mm
12-488-002

○
4mm
12-489-003

○
5mm
12-490-004

○
6mm
12-491-005

○ $\frac{1}{2}$
7mm
12-492-006

KEYES
12-487-001 — 12-492-006
Dermal Punches

○ 2mm ○ 3mm ○ 4mm ○ 5mm ○ 6mm ○ $\frac{1}{2}$ 7mm



KEYES MODIF.
12-493-001
Dermal Punches
compl. Set with 6 interchangeable tips

PUNCHES SPHENOID BONE

Keilbeinstanzen
Pinzas para esfenoides
Pinces pour le sinus sphénoïdal
Pinze sfenoidali taglianti



WEIL-BLAKESLEY
12-494-125

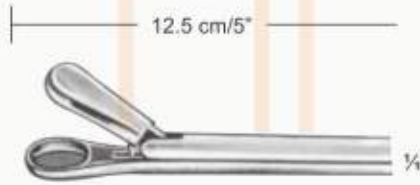

WATSON-WILLIAMS
12-504-125



WATSON-WILLIAMS
12-505-125



WEIL-BLAKESLEY
12-503-125

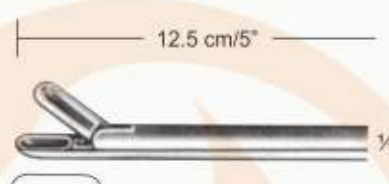

WATSON-WILLIAMS
12-506-125

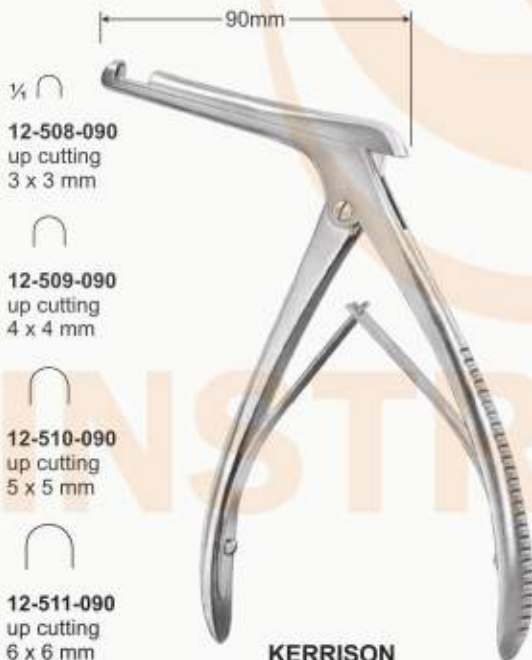

KERRISON
12-507-090
9 cm



BEYER
12-512-090

BRONCH-OESOPHAGOSCOPY FORCEPS

Broncho-Oesophagoskopiezangen
Pincas pour broncho-oesophagoscopie

Pinzas para bronch-esofagoscopia
Pinze per bronco-oesophagoscopia

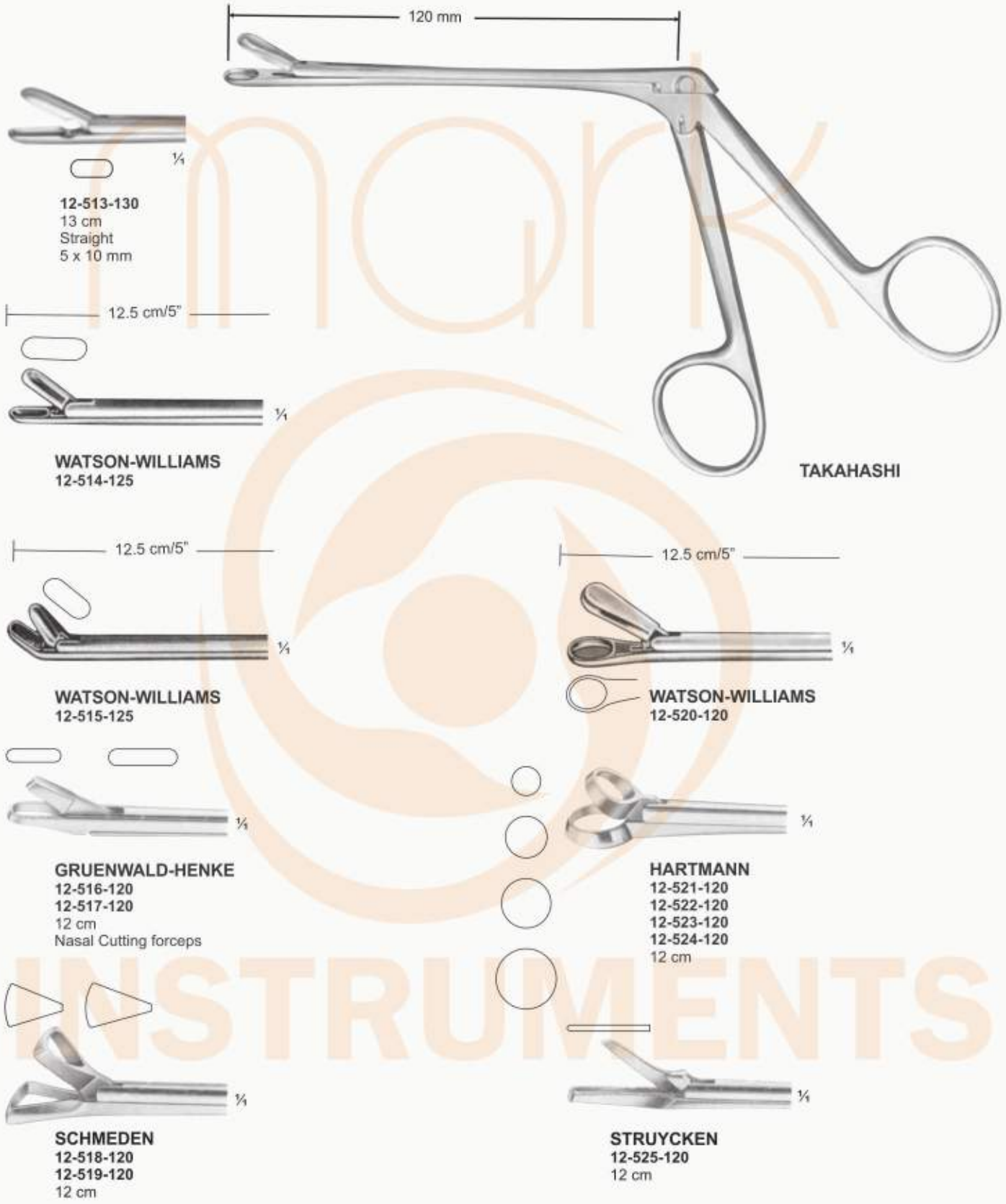

RINGMESSER

adenoid currettes

Couteaux a vegetations adenoides

Cuchillos para vegetaciones adenoides

Adenotomi



TOBOLD
12-526-145
14.5 cm



WEIDER

12-527-145 12-528-145
14.5 cm 14.5 cm
serrated 28 mm serrated 32 mm



TONGUE DEPRESSOR
12-529-145
14.5 cm



TONGUE DEPRESSOR
12-530-145
14.5 cm



BUCHWALD
12-531-180
18 cm



BRUENINGS
12-532-190
19 cm



FRENZEL
12-533-165
16.5 cm



M-SCHMIDT
12-534-190
19 cm

MOUTH GAGS

Mundsperrer Abreboacas
 Ouvre-bouches Apribocca



FERGUSON-ACKLAND
 12-535-145
 14.5 cm



DENHARDT
 12-536-125
 12.5 cm
 Mouth Gag
 with silicon inserts,
 interchangeable



ROSER-KONIG
 12-537-160
 16 cm
 Mout Gag



DOYEN-COLLIN
 12-538-120 12 cm
 12-539-140 14 cm
 Mout Gag



MOLT
 12-540-100
 10 cm
 Mouth Gag
 for children



MOLT
 12-541-140
 14 cm



HEISTER
 12-542-130
 13 cm
 Mouth Gag



WHITEHEAD
 12-543-090 9 cm
 12-544-110 11 cm
 12-545-130 13 cm
 12-546-150 15 cm
 Mouth Gag



WHITEHEAD
 12-547-110 11 cm
 12-548-130 13 cm
 12-549-150 15 cm
 Mouth Gag
 with tongue depressor



WHITEHEAD-JENNINGS
 12-550-090 9 cm
 12-551-110 11 cm
 12-552-130 13 cm
 12-553-150 15 cm
 Mouth Gag

MOUTH GAGS

Mundsperrer Abrebocas
Ouvre-bouches Apribocca



DAVIS-BOYLE
12-554-001
Complete Set
Double Bite-Lift Side
Gag only left side



12-555-001



12-556-002



12-557-003



12-558-004



12-559-005

DAVIS-BOYLE
12-555-001 19 X 25mm
12-556-002 25 X 62mm
12-557-003 25 X 75mm
12-558-004 25 X 92mm
12-559-005 25 X 108mm
Tongue Blades only.



12-560-001
Gag Only

MCIVOR



12-561-001
Complete Set
with 3 Blades

MCIVOR
blade



MODELL WURZBURG
12-562-001 66 x 28 mm
12-563-002 75 x 32 mm
12-564-003 83 x 34 mm
12-565-004 93 x 37 mm
12-566-005 100 x 38 mm

MOUTH GAGS

Mundsperrer Abreboças
Ouvre-bouches Apribocca



RUSSEL-DAVIS

- 12-567-001 29 x 67 mm
- 12-568-002 33 x 75 mm
- 12-569-003 38 x 85 mm
- 12-570-004 40 x 92 mm
- 12-571-005 46 x 100 mm



RUSSEL-DAVIS

- 12-572-001 18 x 57 mm
- 12-573-002 22 x 67 mm
- 12-574-003 25 x 75 mm

INSTRUMENTS

MOUTH GAGS

Mundsperrer Abre bocas
 Ouvre-bouches Apribocca



12-575-001
 Gag only

KILNER-DOUGHTY
 12-576-002
 complete



1/2
 12-577-003
 65 x 28 mm



12-579-005



1/2
 12-578-004
 75 x 32 mm



1/2
 12-580-006
 80 x 37 mm



NEGUS
 12-581-001
 Chest support for Mouth Gag



12-584-003
 55 x 25 mm



12-585-004
 60 x 27 mm



12-586-005
 70 x 30 mm

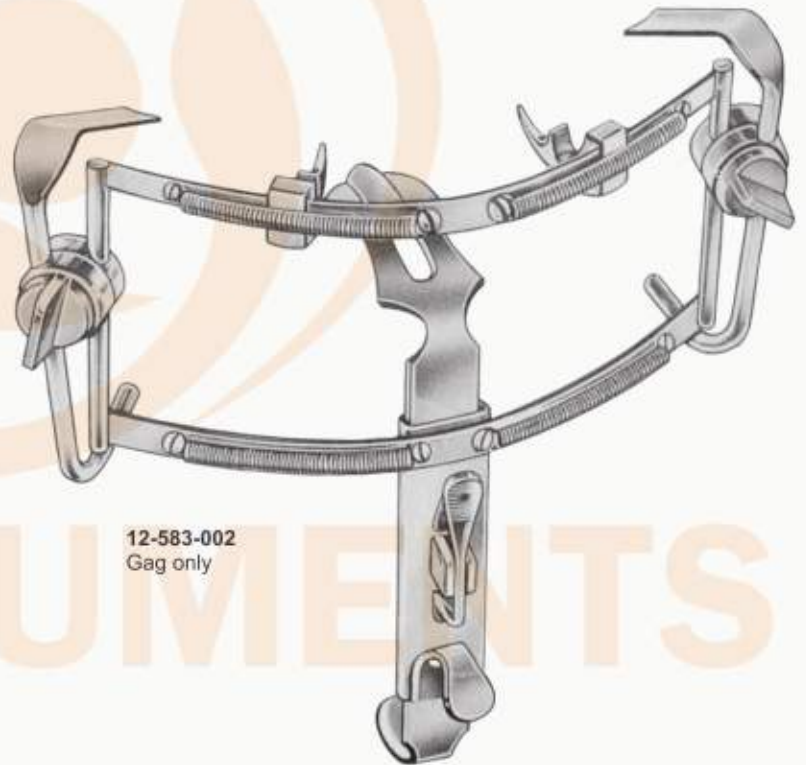

12-583-002
 Gag only

DINGMANN
 12-582-001
 complete

MOUTH GAGS

Mundsperrer Abre bocas
 Ouvre-bouches Apribocca



SIMPLEX
 12-587-110
 11 cm



STERNBERG
 12-588-120 12 cm
 12-589-140 14 cm
 12-590-160 16 cm



HARTMANN
 12-591-150
 15 cm



UNIV. MINNESOTA
 12-592-140
 14 cm



12-593-190
 19 cm



ROUX
 12-594-150
 15 cm



12-595-200
 15 x 15 mm



12-596-210
 20 x 22 mm



12-597-230
 26 x 30 mm

MIDDELDORPF
 12-595-200 20 cm
 12-596-210 21 cm
 12-597-230 23 cm

INSTRUMENTS

TONSIL FORCEPS

INSTRUMENTS

Tonsilleninstrumente
 Instruments pour amygdales

Instrumentos para amígdalas
 Strumenti per tonsille



MARSCHIK-KRONE
 12-598-205
 20.5 cm



ABRAHAM
 12-599-205
 20.5 cm



BLOHMKE
 12-600-205
 20.5 cm



BLOHMKE
 12-601-205
 20.5 cm



WHITE
 12-602-180 18 cm
 12-603-230 23 cm



12-604-190

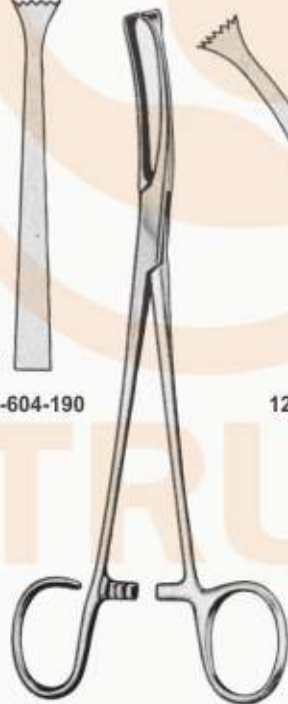

COLVER
 19 cm



12-605-190



MUSEUX
 12-606-190
 19 cm

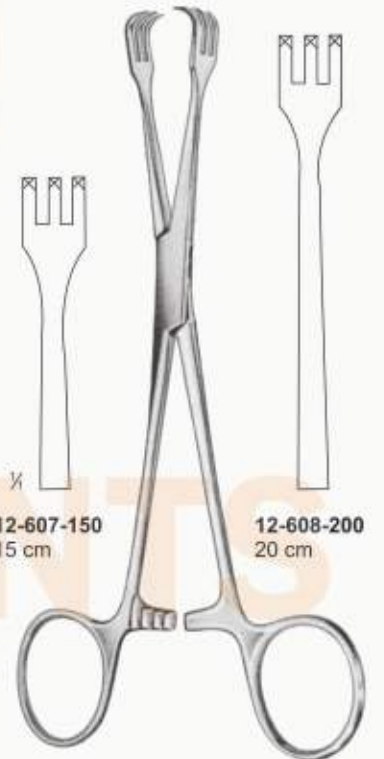

LAHEY

12-607-150
 15 cm

12-608-200
 20 cm

TONSIL INSTRUMENTS

Tonsilleninstrumente

Instrumentos para amígdalas

Instruments pour amygdales

Strumenti per tonsille

INSTRUMENTS



TONSIL INSTRUMENTS

Tonsilleninstrumente
 Instruments pour amygdales

Instrumentos para amígdalas
 Strumenti per tonsille



BOETTCHER
 12-623-180
 18 cm



DEAN
 12-624-170
 17 cm

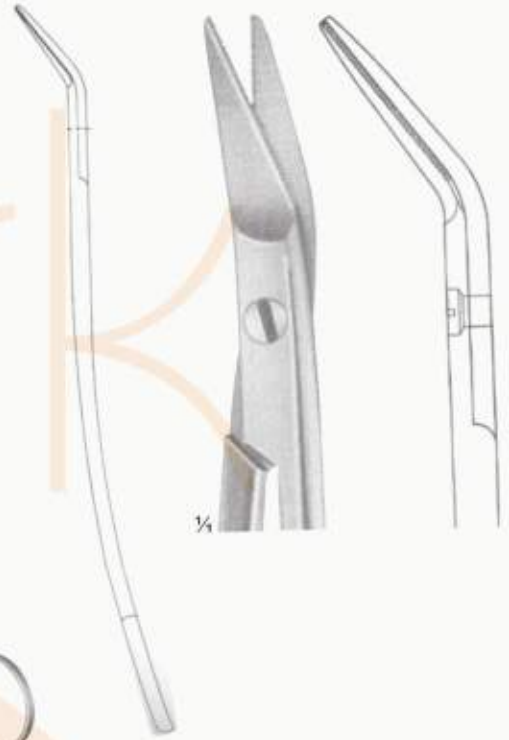

GOOD
 12-625-195
 19.5 cm



SCHWECKENDIEK
 12-626-195
 19.5 cm



TONSIL INSTRUMENTS

Tonsilleninstrumente
Instruments pour amygdales

Instrumentos para amígdalas
Strumenti per tonsille



EVES
12-627-280
28 cm

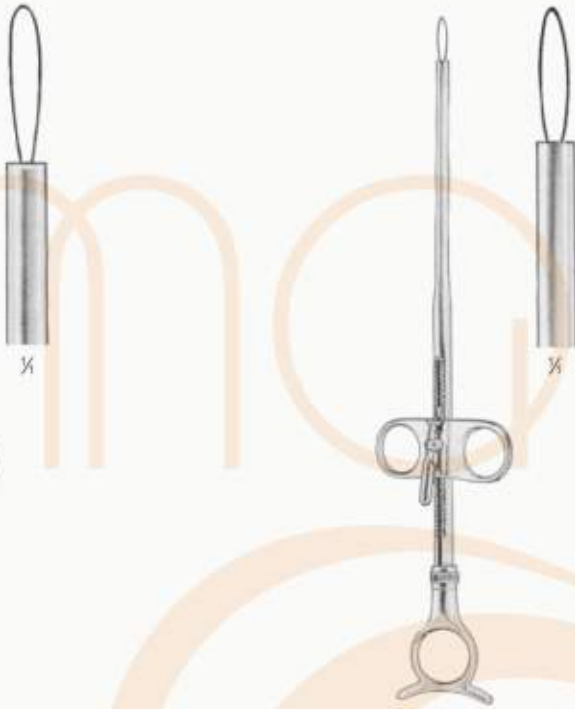

EVES
12-628-280
28 cm



BRUENINGS
12-629-280
28 cm



Pack. Of 100 pcs.
12-630-001 = 40mm
12-631-002 = 50mm



TYDING
12-633-001

Pack. Of 12 pcs.
12-632-001 = 0.3mm

TONSIL INSTRUMENTS

Tonsillieninstrumente
Instruments pour amygdales

Instrumentos para amígdalas
Strumenti per tonsille



12-634-001



12-635-002



12-636-003



SLUDER-BALLENGER
12-634-001 to 12-636-003
Complete, with 3 tips fig. 1-3



RODER
12-637-265
26.5 cm



HOFER
12-638-240
24 cm



NAGER
12-639-230
23 cm



LOVE
12-640-180 18mm
12-641-200 20mm
12-642-220 22mm



HASLINGER
12-643-170
17 cm



MATIN
12-644-170
17 cm

RINGMESSER

adenoid currettes

Couteaux a vegetations adenoides

Cuchillos para vegetaciones adenoides

Adenotomi



12-645-220
12-646-220



12-647-220
12-648-220



12-649-220
12-650-220



12-651-220
12-652-220



12-653-220
12-654-220



12-655-220
12-656-220



BECKMANN (Negus)
12-645-220 —
12-656-220
22cm



BARNHILL
22cm



12-657-220



12-658-220



12-659-220

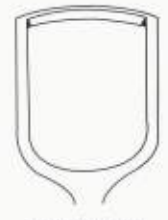

12-660-220

BECKMANN
12-645-220 —
12-656-220
22 cm



ST. CLAIR-THOMSON
21cm



12-661-210



12-662-210



12-663-210



12-664-210



LA FORCEPS
Adenotomes
23 cm



12-665-230



12-666-230



12-667-230

LARYNGEAL POLYPUD FORCEPS

Kehlkopfpolypenzangen
Pincas a polypes laryngiens

Pinzas para polipos laringeos
Pinze per polipi laringei



JATHO
12-668-001
Biopsy forceps, for nasopharynx and hypopharynx, malleable shaft, right side opening

Biopsy forceps, for nasopharynx and hypopharynx, malleable shaft, left side opening

JATHO
Nasopharynx forceps
12-669-240
24 cm



JURASZ
12-670-220 lateral biting to the right
12-671-220 lateral biting to the left
12-672-220 downwards biting
12-673-220 upwards biting
22 cm

12-670-220

12-671-220

12-672-220

12-673-220

TOBOLD
12-674-230
23 cm

LARYNGEAL MIRRORS

Kehlkopfspiegel *Espejos laringeos*
Miroirs laryngiens *Specchi laringei*



LARYNGEAL MIRROR
with Handle

12-675-001
00 8mm

12-676-002
0 10mm

12-677-003
1 12mm

12-678-004
2 14mm

12-679-005
3 16mm

12-680-006
4 18mm



12-681-007
5 20mm



12-682-008
6 22mm



12-683-009
7 24mm



12-684-010
8 26mm



MIRROR
12-685-150
15 cm



Handle for
All Sizes
12-686-150
15 cm



12-687-001
1 - Electric mirror handle with light
2 - With three spare battery

RETRACTORS

Wundhäkchen, Mikrohäkchen
 Ganchito, Micro Ganchitos

Crochet, Micro crochetes
 Divaricatore, Micro Divaricatori



BRÜNINGS

12-688-001

Universal handle, with lever on the left, for use with tubes

12-693-200 to 12-698-500



AESCULAP

12-689-001

Universal handle, with lever on the right, for use with tubes

12-693-200 to 12-698-500



HUBER

12-690-001

Universal handle, with lever on the right, for use with tubes

12-693-200 to 12-698-500



BRÜNINGS

12-691-200

20 cm

Curved Tube with Stylet,

12-692-200

20 cm

Curved Tube with Stylet,



BRÜNINGS

12-693-200 20 cm

12-694-250 25 cm

12-695-300 30 cm

12-696-350 35 cm

12-697-400 40 cm

12-698-500 50 cm

Straight Tubes with Stylet, stiff

LARYNGEAL POLYPUD FORCEPS

Kehlkopfpolypenzangen
Pinces a polypes laryngiens

Pinzas para polipos laringeos
Pinze per polipi laringei

12-699-001



LANGE
12-711-001



12-700-001



KRAUSE
12-712-001
12-713-002



KAHLER
12-701-001



EICKEN
12-702-001



SCHEINMANN
12-714-001



FRAENKEL
12-703-001



SCHEINMANN
12-715-001



FRAENKEL
12-704-001



SCHEINMANN
12-705-001



CORDES
12-716-001



BRÜNING'S
12-706-001 Ø 2 mm.
12-707-002 Ø 3 mm.
12-708-003 Ø 4 mm.



CORDES
12-717-001



BRÜNING'S
12-709-001



ROSENBRG
12-718-001



LANGE
12-710-001



STRUYCKEN
12-719-001





LARYNGEAL POLYPUD FORCEPS

Kehlkopfpolypenzangen
Pincas a polypes laryngiens

Pinzas para polipos laringeos
Pinze per polipi laringei



12-720-001
Chest Support and Laryngoscope Holder,
complete, for adults and children

12-721-180
18 cm
Operating Laryngoscope,
for adults, large



12-722-180
18 cm
Operating Laryngoscope,
for adults, medium



12-723-130
13 cm
Operating Laryngoscope,
for children



12-724-180
18 cm
Operating Laryngoscope,
for adults, small



12-725-001
Light guide for use laryngoscopes



12-726-002
Light guide for use laryngoscopes



INSTRUMENTS

SUCTION TUBES

Saugrohre Tubos de aspiracion
Canules d'aspiration Tubi per aspirazióne



FERGUSSON

12-727-180 Ø 2,0 mm, 6 F.G.
12-728-180 Ø 2,0 mm, 7-8 F.G.
12-729-180 Ø 3,0 mm, 9 F.G.
12-730-180 Ø 4,0 mm, 12 F.G.
12-731-180 Ø 5,0 mm, 15 F.G.
18 cm



PLESTER

12-732-195 Ø 1,5 mm, 4-5 F.G.
12-733-195 Ø 2,0 mm, 6 F.G.
12-734-195 Ø 2,5 mm, 7-8 F.G.
12-735-195 Ø 3,0 mm, 9 F.G.
19.5 cm



NASAL SUCTION TUBES

12-736-160 Ø 5 mm
16 cm



FRAZIER

12-737-180 Ø 3 mm
12-738-180 Ø 5 mm
18 cm



FRAZIER

12-739-175
Outside 4,5 diam.
17.5 cm



12-740-175
Outside 5,5 diam.
17.5 cm

TRACHER TUBES

INSTRUMENTS

Trachealkanulen

Cabykas oara ka traqyea

Canules pour la tracheotomie

Cabbyke tracheali



TRACHEA TUBE
outer tube window
inner tube window
12-741-001

Fig.	Item	Ø	L
A	12-742-060	7mm	60mm
A	12-743-065	8mm	65mm
A	12-744-070	9mm	70mm
A	12-745-075	10mm	75mm
A	12-746-080	11mm	80mm
A	12-747-085	12mm	85mm
A	12-748-090	13mm	90mm



SPEAKING TUBE
outer tube closed
inner tube closed
12-749-001

Fig.	Item	Ø	L	Radius
A	12-750-095	08mm	95mm	50mm
A	12-751-095	09mm	95mm	50mm
A	12-752-095	10mm	95mm	50mm
A	12-753-095	11mm	95mm	50mm
A	12-754-095	12mm	95mm	50mm
A	12-755-095	13mm	95mm	50mm

International scale for tracheal tubes, metal



LUER

GERMAN SILVER Diam. X length

12-756-095 Fig. 0	= 4 x 50 mm
12-757-095 Fig. 1	= 5 x 50 mm
12-758-095 Fig. 2	= 6 x 50 mm
12-759-095 Fig. 3	= 7 x 55 mm
12-760-095 Fig. 4	= 8 x 60 mm
12-761-095 Fig. 5	= 9 x 65 mm
12-762-095 Fig. 6	= 10 x 70 mm
12-763-095 Fig. 7	= 11 x 80 mm
12-764-095 Fig. 8	= 12 x 90 mm
12-765-095 Fig. 9	= 13 x 90 mm
12-766-095 Fig. 10	= 14 x 90 mm

JACKSON

short pattern with obturator

Diam. X length

12-767-095 Fig. 1	= 5 x 36 mm
12-768-095 Fig. 2	= 6 x 44 mm
12-769-095 Fig. 3	= 7 x 48 mm
12-770-095 Fig. 4	= 8 x 52 mm
12-771-095 Fig. 5	= 9 x 56 mm
12-772-095 Fig. 6	= 10 x 56 mm
12-773-095 Fig. 7	= 11 x 56 mm
12-774-095 Fig. 8	= 12 x 56 mm
12-775-095 Fig. 9	= 13 x 56 mm
12-776-095 Fig. 10	= 14 x 56 mm



Diam. X length

12-777-095 Fig. 5	= 9 x 65 mm
12-778-095 Fig. 6	= 10 x 70 mm
12-779-095 Fig. 7	= 11 x 80 mm



Speaking Tube

TRACHER DILATORS

Trachealdilatatoren

Dilatateurs pour la tracheotomie

Dilatadores para la traqueotomia

Dilatatori tracheali



LABORDE
 12-780-140
 14 cm



TROUSSEAU
 12-781-140
 14 cm



COLLIN
 12-782-160 16 cm
 12-783-180 18 cm



YOUNG
 12-784-170
 17 cm



1/4
12-785-001
 pair

INSTRUMENTS

TRACHEOTOMY SET

tracheotomiebesteck

Trousse pour la tracheotomie

Estuche para la traqueotomia

Astuccio per tracheotomia

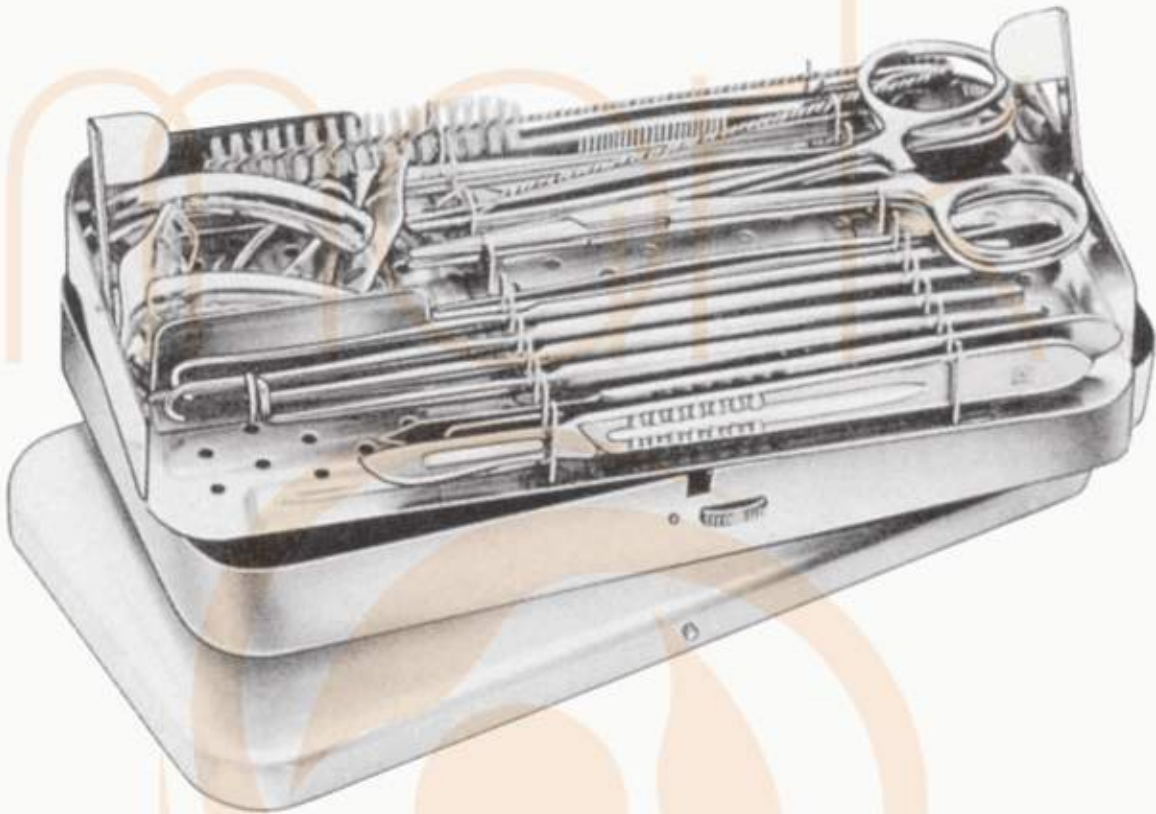

- 12-787-002 1 Metal Case
- 12-788-003 1 Handle With 1 Blade Fig. 20
- 12-789-004 1 Handle With 1 Blade Fig. 23
- 12-790-005 1 Dressing Forceps 13cm
- 12-791-006 2 Tissue Artery Forceps 13cm
- 12-792-007 2 Pean Artery Forceps 13cm
- 12-793-008 1 Grooved Director 13cm
- 12-794-009 1 Trachea Dilator Bose
- 12-795-0010 2 Trachea Retractors, Iterson, Blunt
- 12-796-0012 1 Trachea Retractor, Bose, Sharp, Left
- 12-797-0013 1 Trachea Retractor, Bose, Sharp Right
- 12-798-0014 1 Luer Trachea Tube Standard, Fig. 3
- 12-799-0015 1 Luer Trachea Tube Standard, Fig. 4
- 12-800-0016 1 Cleaning Brush

INSTRUMENTS

HOOKLET & SKIN HOOKS

Wundhäkchen, Mikrohäkchen
 Ganchito, Micro Ganchitos

Crochet, Micro crochets
 Divaricatore, Micro Divaricatori

INSTRUMENTS



HOOK RETRACTOR,
 12-801 -160
 single, blunt
 16 cm



HOOK RETRACTOR,
 12-802-160
 16 cm
 double, blunt



ROSE
 12-803-130
 13 cm



LUER
 12-804-110
 11 cm



JACKSON
 12-805-150
 15 cm



NEWS
 12-806-150
 15 cm



Left

BOSE
 12-807-160
 16 cm



Right

BOSE
 12-808-160
 16 cm



ITERSON
 16 cm



12-809-160



12-810-160



SCHOENBORN
 12-811-210
 21 cm



LUKENS
 12-812-170
 17 cm

SECTION - 13

INTESTINAL AND RECTAL



INTESTINAL & TISSUE GRASPING FORCEPS

Darm-und Gewebefasszangen Pincés Pour Saisir Intestins et Tissus
Pinzas Para Intestinos y Tejidos Pinze Per Afferrare Intestino e Tessuti



ALLIS
13-001-150
15 cm
3 x 3 teeth
4 x 5 teeth
5 x 6 teeth



JUDD-ALLIS 3:4
13-002-150 15.0 cm
13-003-190 19.0 cm



LOCKWOOD
13-004-200
20 cm



WILLIAMS
13-005-160
16 cm



BABCOCK
13-006-160 16 cm 8 mm
13-007-180 18 cm 10 mm
13-008-200 20 cm 13 mm



LANE
13-009-150 15 cm
13-010-180 18 cm
13-011-200 20 cm



LITTLE WOOD
13-012-190
19 cm, Box Joint,



DUVAL

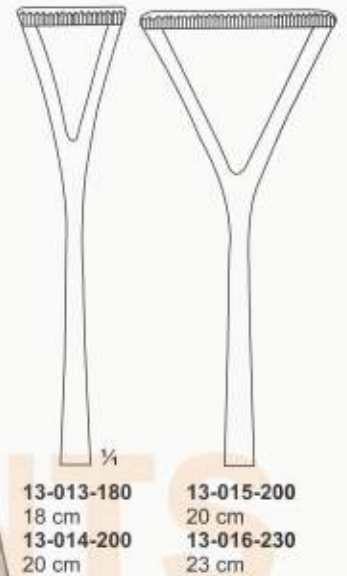

13-013-180 18 cm
13-014-200 20 cm

13-015-200 20 cm
13-016-230 23 cm

INTESTINAL CLAMPS

Darmklemmen Pincas Intestinales
Pinzas Intestinales Pinze Intestinali



13-017-165
16.5 cm
13-018-180
18 cm

BABY-DOYEN



13-019-165
16.5 cm
13-020-180
18 cm



13-021-210
21 cm
13-022-230
23 cm
13-023-250
25 cm

MAYO-ROBSON



13-024-210
21 cm
13-025-230
23 cm
13-026-250
25 cm

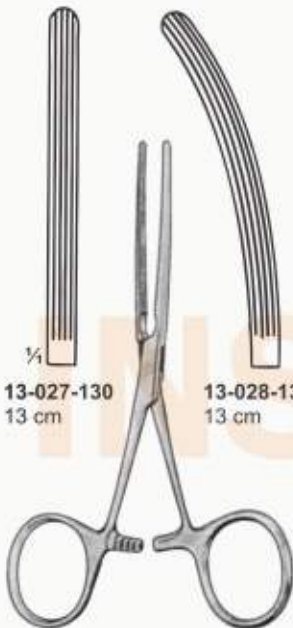

13-027-130
13 cm

13-028-130
13 cm

BABY-KOCHER



13-029-220
22 cm
Straight

KOCHER



13-030-220
22 cm
Curved, grooved

DOYEN

POLYOUS GRASPING FORCEPS, ANASTOMOSIS

Polyperfasszange, Darm-anastomosenklemmen

Pince Pour Saisir Polypes, Pincés-clamps Pour Anastomose Intestinale

Pinza Para Coger Pólipos, Clamps Para Anastomosis Intestinales

Pinze Per Afferrare Polipi, Pinze Per Anastomosi Intestinali



13-031-220
22 cm
Straight

13-032-250
25 cm
Straight

13-033-280
28 cm
Straight



KOCHER

13-034-220
22 cm
Curved

13-035-250
25 cm
Curved

13-036-280
28 cm
Curved



BRUNNER
13-037-240
24.0 cm

RESANO
13-038-300
30.0 cm

FEHLAND
13-039-240
24.0 cm

INTESTINAL CLAMPS

INSTRUMENTS

Darmklemmen Pincas Intestinales
 Pinzas Intestinales Pinze Intestinali



BAINBRIDGE



**DOYEN
 Atraumatic**

INTESTINAL CLAMPS

Darmklemmen *Pincas Intestinales*
Pinzas Intestinales *Pinze Intestinali*

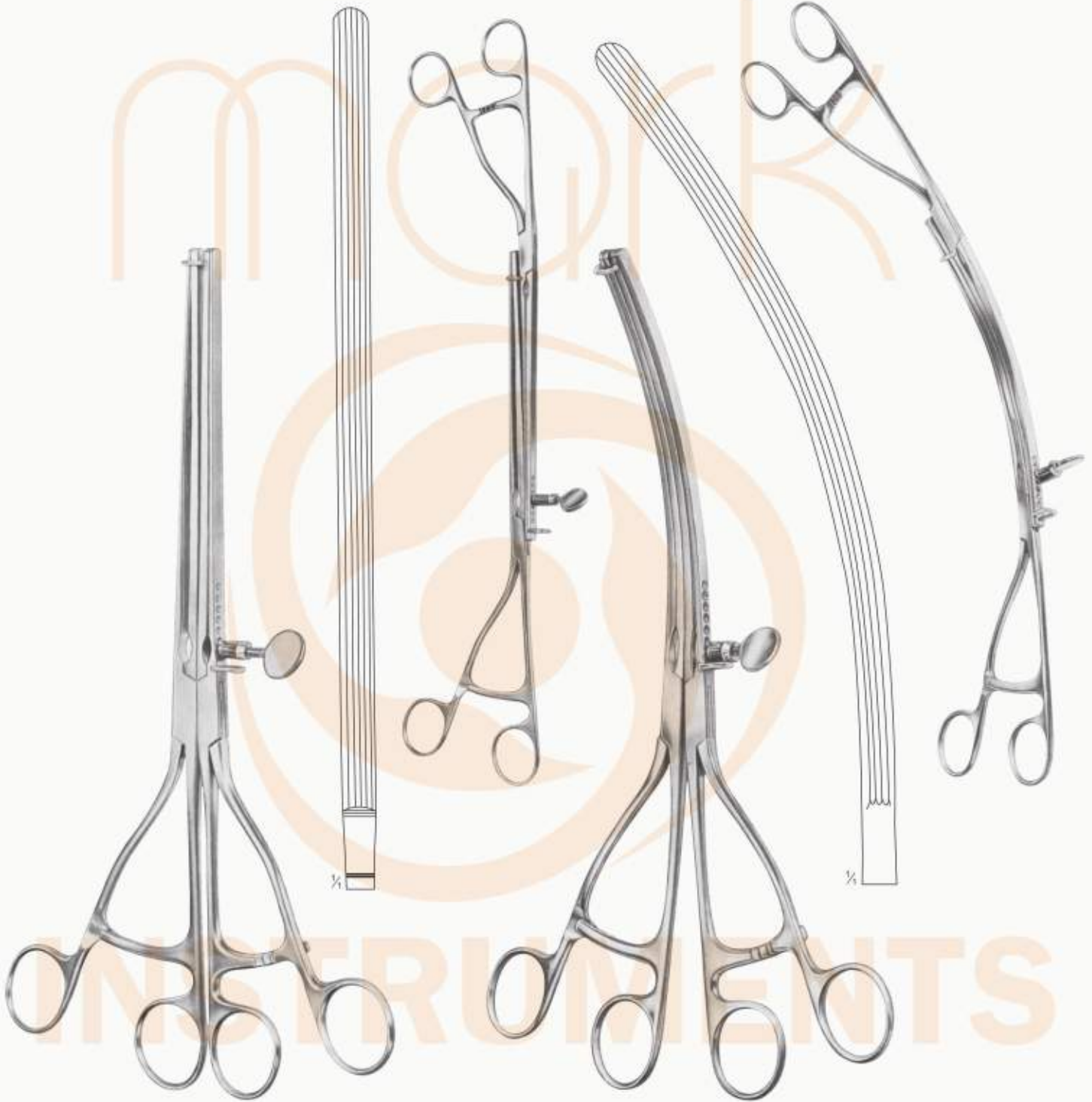

LANE Str.
13-052-300
 30 cm

LANE Cvd.
13-053-300
 30 cm

INTESTINAL CLAMPS

Darmklemmen Pincas Intestinales
 Pinzas Intestinales Pinze Intestinali



PAYR-BABY
 13-054-150
 15.0 cm
 without pin
 13-055-150
 15.0 cm
 with pin

PAYR
 13-056-210
 21.0 cm
 without pin
 13-057-210
 21.0 cm
 with pin

PAYR
 13-058-290
 29 cm
 without pin
 13-059-290
 29 cm
 with pin

PAYR
 13-060-350
 35 cm
 without pin
 13-061-350
 35 cm
 with pin

POLYOUS GRASPING FORCEPS, ANASTOMOSIS

INSTRUMENTS

Polyperfasszange, Darm-anastomosenklemmen

Pince Pour Saisir Polypes, Pincés-clamps Pour Anastomose Intestinale

Pinza Para Coger Pólipos, Clamps Para Anastomosis Intestinales

Pinze Per Afferrare Polipi, Pinze Per Anastomosi Intestinali

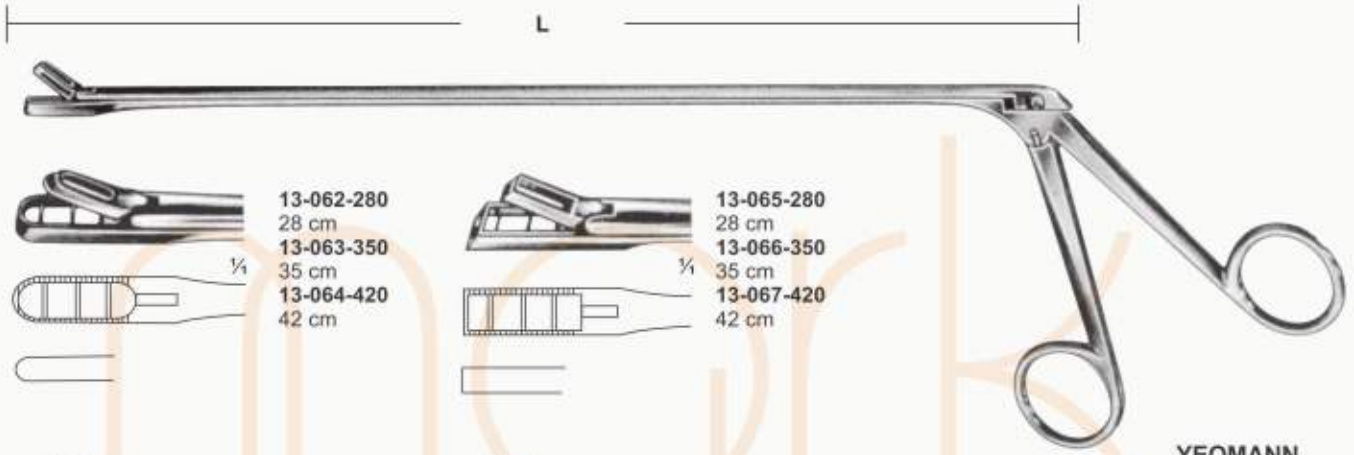

YEOMANN

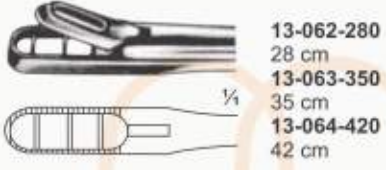

13-062-280
28 cm
13-063-350
35 cm
13-064-420
42 cm

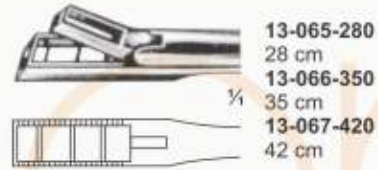

13-065-280
28 cm
13-066-350
35 cm
13-067-420
42 cm

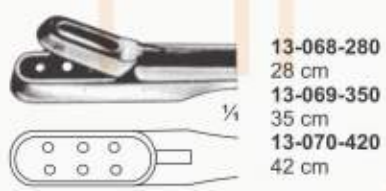

13-068-280
28 cm
13-069-350
35 cm
13-070-420
42 cm

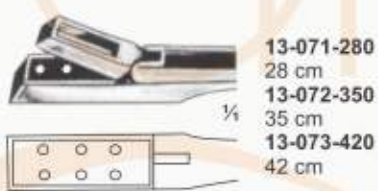

13-071-280
28 cm
13-072-350
35 cm
13-073-420
42 cm



Jaw length
13-074-100
10 cm
Jaw length
13-075-070
7 cm
Jaw length
13-076-050
5 cm

DE MARTEL-WOLFSON
set of 3
anastomosis clamps



DE MARTEL-WOLFSON
13-077-260
26.0 cm

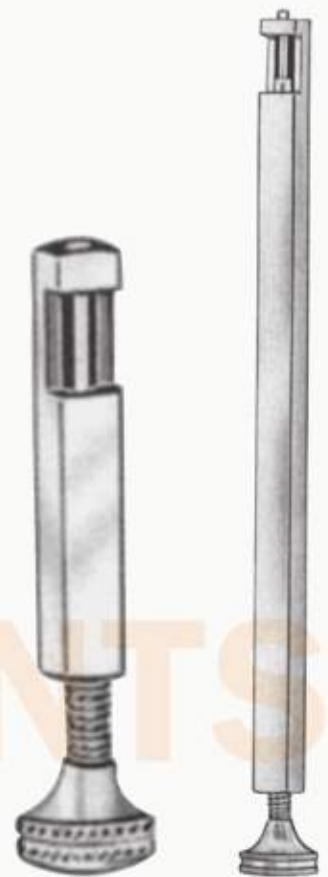

13-078-085
8.5 cm
DE MARTEL-WOLFSON
13-079-230
23 cm

INTESTINAL RECTAL SPECULA

Mastdarmspekula Spéculums Rectaux
 Espéculos Rectales Specoli Rettali



MATHIEU
 13-080-195
 19.5 cm
 90 x 15 mm



SIMS
 13-081-150
 15.0 cm



SIMS
 13-082-150
 15.0 cm



IVES-FANSLER
 13-083-080
 8 cm
 80 x 22 mm



PRATT
 13-084-215
 21.5 cm
 85 x 25 mm blade



CZERNY
 13-085-220
 22.0 cm

INTESTINAL RECTAL SPECULA

Mastdarmspekula Spéculums Rectaux
 Espéculos Rectales Specoli Rettali



- 13-086-00
- 16 ø x 65 mm
- 13-087-00
- 19 ø x 65 mm
- 13-088-00
- 22 ø x 65 mm
- 13-089-00
- 22 ø x 125 mm

HIRSCHMANN

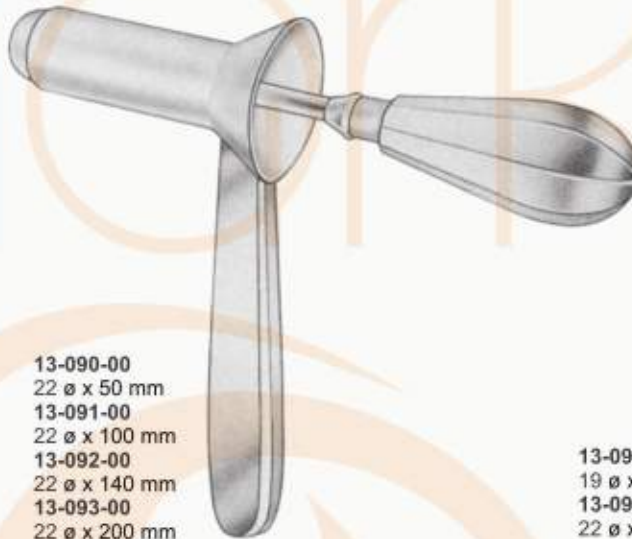

- 13-090-00
- 22 ø x 50 mm
- 13-091-00
- 22 ø x 100 mm
- 13-092-00
- 22 ø x 140 mm
- 13-093-00
- 22 ø x 200 mm

KELLY



- 13-094-00
- 19 ø x 70 mm
- 13-095-00
- 22 ø x 70 mm

BENSAUDE



- 13-096-150
- 15 cm
- 75 x 23 mm

SMITH-BLUE



SCHULZE-BERGMANN



- 13-097-220 22 cm
- 60 mm
- 13-098-220 22 cm
- 80 mm
- 13-099-220 22 cm
- 125 mm
- 13-100-220 22 cm
- 150 mm

INSTRUMENTS

INTESTINAL & TISSUE GRASPING FORCEPS T.C.

Darm-und Gewebefasszangen Pincés Pour Saisir Intestins et Tissus
 Pinzas Para Intestinos y Tejidos Pinze Per Afferrare Intestino e Tessuti

INSTRUMENTS



ALLIS
 13-101-150 15 cm
 13-102-200 20 cm
 13-103-220 22 cm
 13-104-250 25 cm
 13-105-300 30 cm

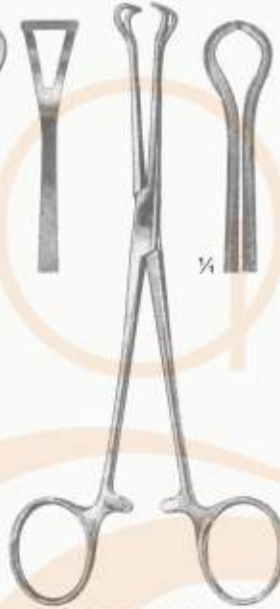

BABCOCK
 13-106-160 16 cm
 13-107-215 21.5 cm



DUVAL
 13-108-250 25 cm
 13-109-270 27 cm



BABCOCK



13-110-165 16.5 cm 13-111-203 20.3 cm

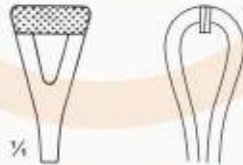

13-112-175 17.5 cm

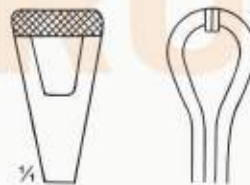

13-113-195 19.5 cm



DUVAL



13-114-130 13 cm



13-115-180 18 cm

SECTION - 14

GYNECOLOGY / OBSTETRICS



VAGINAL SPECULA

Scheidenspekula Espéculos vaginales
Spéculums vaginaux Specoli vaginali



GRAVES
14-001-001 75 x 20 mm
Small
14-002-002 95 x 35 mm
Medium
14-003-003 115 x 35 mm
Large



AUVARD
14-004-001 Long Blade
102 x 44 mm
14-005-002 Fixed Weight
86 x 32 mm



PEDERSON
14-006-001 75 x 13 mm
Small
14-007-002 100 x 22 mm
Medium
14-008-003 120 x 25 mm
Large



CUSCO
14-009-001 75 x 32 mm
14-010-002 85 x 35 mm
14-011-003 100 x 35 mm



CUSCO
14-012-004 75 x 18 mm



CUSCO
14-013-001 80 x 22 mm
14-014-002 100 x 25 mm
14-015-003 105 x 27 mm



VAGINAL SPECULA

Scheidenspekula *Espéculos vaginales*
Spéculums vaginaux *Specoli vaginali*



CUSCO

14-016-001 75 x 34 mm
 14-017-002 85 x 37 mm
 14-018-003 100 x 37 mm



COLLIN

14-019-001 85 x 30 mm
 14-020-002 100 x 35 mm
 14-021-003 110 x 40 mm



SEMM

14-022-001 100 x 20 - 25 mm
 14-023-002 105 x 27 - 3.5 mm



WINTERTON

14-024-001



TRELAT

14-025-001 85 mm 33 mm
 14-026-002 95 mm 35 mm
 14-027-003 115 mm 43 mm



INSTRUMENTS

VAGINAL SPECULA

Scheidenspekula *Espéculos vaginales*
Spéculums vaginaux *Specoli vaginali*



SIMS
14-028-001 65 x 25 / 70 x 30 mm
14-029-002 70 x 30 / 70 x 35 mm
14-030-003 85 x 35 / 90 x 40 mm



KRISTELLER
14-031-001 70 x 27 mm
14-032-002 80 x 30 mm
14-033-003 90 x 36 mm



KRISTELLER
14-034-001 75 x 23 mm
14-035-002 85 x 26 mm
14-036-003 100 x 32 mm



Slender Pattern

KRISTELLER
14-037-001 105 x 18 mm
14-038-002 105 x 21 mm



Slender Pattern

KRISTELLER
14-039-001 110 x 14 mm
14-040-002 110 x 17 mm

INSTRUMENTS

VAGINAL SPECULA

Scheidenspekula *Espéculos vaginales*
Spéculums vaginaux *Specoli vaginali*

Slender Pattern



- KRISTELLER**
14-041-001 105 x 18 mm / 110 x 14 mm
14-042-002 105 x 21 mm / 110 x 17 mm

Flat speculum



- KRISTELLER**
14-043-001 105 x 26 mm
14-044-002 105 x 28 mm
14-045-003 105 x 33 mm



- KRISTELLER**
14-046-001 115 x 22 mm
14-047-002 115 x 24 mm
14-048-003 115 x 29 mm

Flat speculum



- KRISTELLER**
14-049-001 105 x 26 mm / 115 x 22 mm
14-050-002 105 x 28 mm / 115 x 24 mm
14-051-003 105 x 33 mm / 115 x 29 mm

Deep speculum

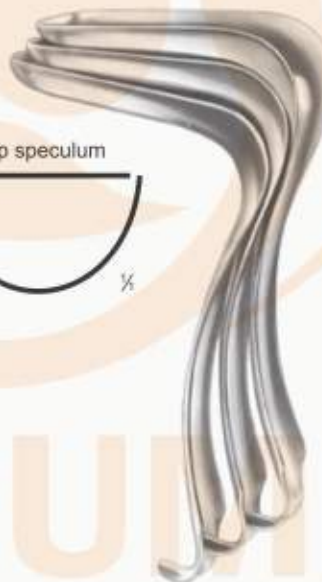
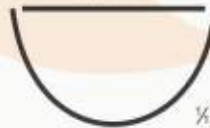

- KRISTELLER**
14-052-001 110 x 27 mm
14-053-002 110 x 30 mm
14-054-003 110 x 36 mm



- KRISTELLER**
14-055-001 115 x 23 mm
14-056-002 115 x 26 mm
14-057-003 115 x 32 mm

VAGINAL SPECULA

Scheidenspekula Espéculos vaginales
 Spéculums vaginaux Specoli vaginali



KALLMORGEN
 14-058-001 70 x 40 mm 6 3/4"
 14-059-002 90 x 40 mm 8 3/4"



KALLMORGEN
 14-060-001 70 x 33 mm 6 3/4"
 14-061-002 90 x 33 mm 8 3/4"

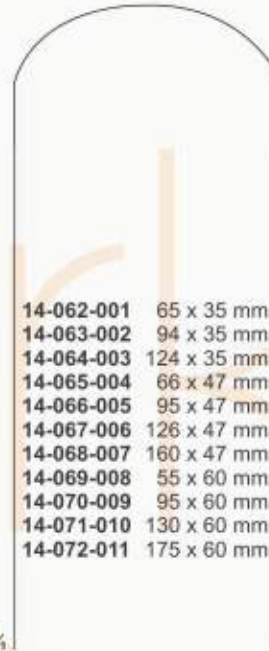

- 14-062-001 65 x 35 mm
- 14-063-002 94 x 35 mm
- 14-064-003 124 x 35 mm
- 14-065-004 66 x 47 mm
- 14-066-005 95 x 47 mm
- 14-067-006 126 x 47 mm
- 14-068-007 160 x 47 mm
- 14-069-008 55 x 60 mm
- 14-070-009 95 x 60 mm
- 14-071-010 130 x 60 mm
- 14-072-011 175 x 60 mm



DOYEN VAGINAL
 14-073-220
 22 cm



LANDON VAGINAL
 14-074-090
 Blade 9 cm
 Deep 2.5 cm wide.



- BREISKY**
- 14-075-001 100 x 20mm
 - 14-076-002 100 x 25mm
 - 14-077-003 100 x 30mm
 - 14-078-004 100 x 35mm
 - 14-079-005 100 x 40mm
 - 14-080-006 130 x 20mm
 - 14-081-007 130 x 25mm
 - 14-082-008 130 x 30mm
 - 14-083-009 130 x 35mm
 - 14-084-010 130 x 40mm
 - 14-085-011 155 x 40mm



LANDAU
 14-086-001 105 x 28 mm
 14-087-002 105 x 38 mm

VAGINAL SPECULA

Scheidenspekula *Espéculos vaginales*
Spéculums vaginaux *Specoli vaginali*

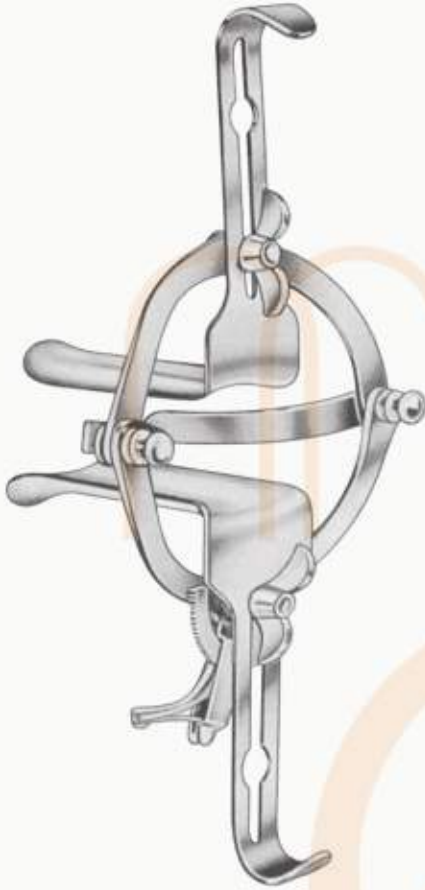

O'SULLIVAN - O'CONNOR
 Set of Complete
 14-088-001
 14-089-002
 14-090-003
 14-091-004



14-089-002
 45 x 17 mm



14-090-003
 90 x 37 mm



14-091-004
 90 x 45 mm



DOYEN
 14-092-090 9 cm wide
 14-093-100 10 cm wide
 14-094-115 11.5 cm wide



DOYEN
 14-095-240 9.5 cm wide
 14-096-270 11.5 cm wide



FRIEDMANN
 14-097-100
 10 cm

VAGINAL SPECULA

INSTRUMENTS

Scheidenspekula Espéculos vaginales
 Spéculums vaginaux Specoli vaginali



NEW PORT
 14-098-250
 25.0 cm



GELPI VULVA
 14-099-001
 self-retaining sharp
 hook jaws

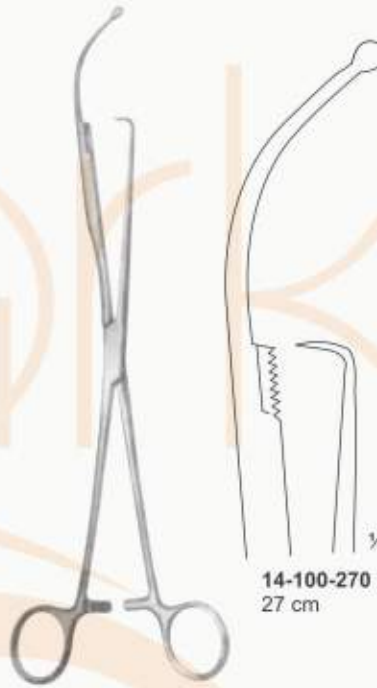

HULKA

14-100-270
 27 cm



KOGAN

14-101-240
 24 cm
 With ratchet
 3 mm



KOGAN
 14-102-240
 24.0 cm

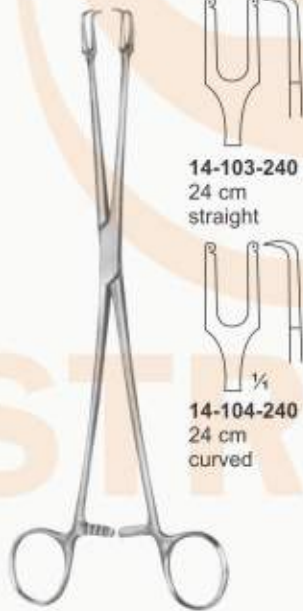

SCHRÖDER



14-103-240
 24 cm
 straight



14-104-240
 24 cm
 curved



SCHRÖDER

14-105-250
 25 cm



POZZI

14-106-250
 25 cm

TENACULUM FORCEPS

INSTRUMENTS

Hakenzangen

Pinces pour l'abaissement du col de l'utérus

Pinzas para coger el cuello del útero

Pinze per abbassare il collo dell'utero



BARRETT
 14-107-180
 18 cm



SAIRGES
 14-108-230
 23 cm



MUSEUX
 24 cm



14-109-240
 6 mm



14-110-240
 8 mm



14-111-240
 10 mm



MUSEUX
 24 cm



14-112-240
 6 mm



14-113-240
 8 mm



14-114-240
 10 mm



PRATT
 14-115-280
 28 cm

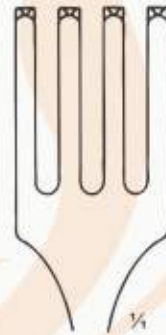

TEALE
 14-116-230
 23 cm



UTERINE SEIZING FORCEPS, MYOMA INSTRUMENTS

Uterusfasszangen, Myom-Instrumente

Pinces hystérolabes, Instruments pour myomes

Histerólabos, Instrumentos para fibroma

Pinze isterolabi, Strumenti per miomi



JACOBS
 14-117-210
 21 cm
 Straight



LOWA
 14-118-260
 26 cm



DARTIGUES
 14-119-270
 27 cm

For polypus forcepssee Section 6.



SOMER
 14-120-230
 23 cm



DOYEN
 14-121-170
 17 cm



DOYEN
 14-122-170
 17 cm

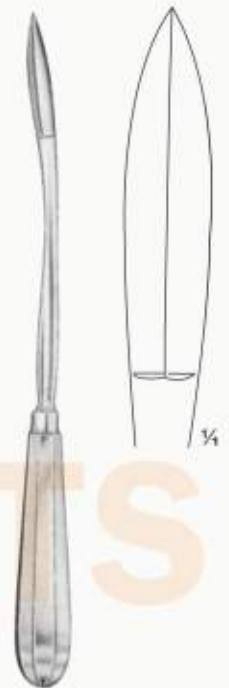

SEGOND
 14-123-270
 27 cm

INSTRUMENTS

ABORTION FORCEPS - OVUM CURETTES

Abortuszangen - Abortusküretten
Pincas à faux germes - Curette d'avortement

Pinzas para abort - Curetas para aborto
Pinze per placenta ed aborto - Curette per placenta ed aborto



BRAUN
14-124-280
28 cm



SIMS
14-125-260
26 cm

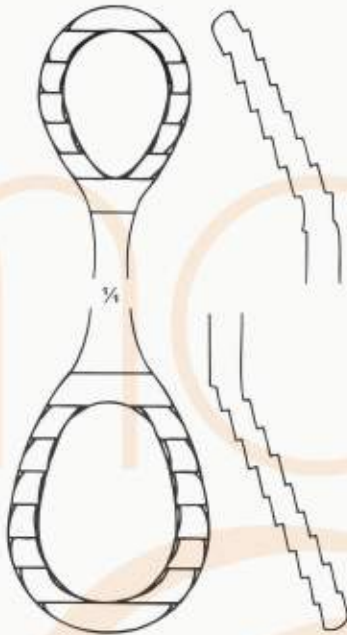

KEVORKIAN



14-126-300
30 cm
1.2mm



14-127-300
30 cm
4.0 mm
Without Basket



14-128-300
30 cm
4.0 mm
With Basket



Sharp



1/4



Blunt

BLAKE
14-129-270
27 cm



COLLIN
28 cm



14-130-280
8.0 mm



14-131-280
10.0 mm



14-132-280
12.0 mm



14-133-280
14.0 mm



GOURDET
28.0 cm



Fig. 1
14-134-280



Fig. 2
14-135-280



Fig. 3
14-136-280



Fig. 4
14-137-280



Fig. 5
14-138-280

UTERINE CURETTES

Uterusküretten Currettes uterinas
Currettes utérines Curette uterine

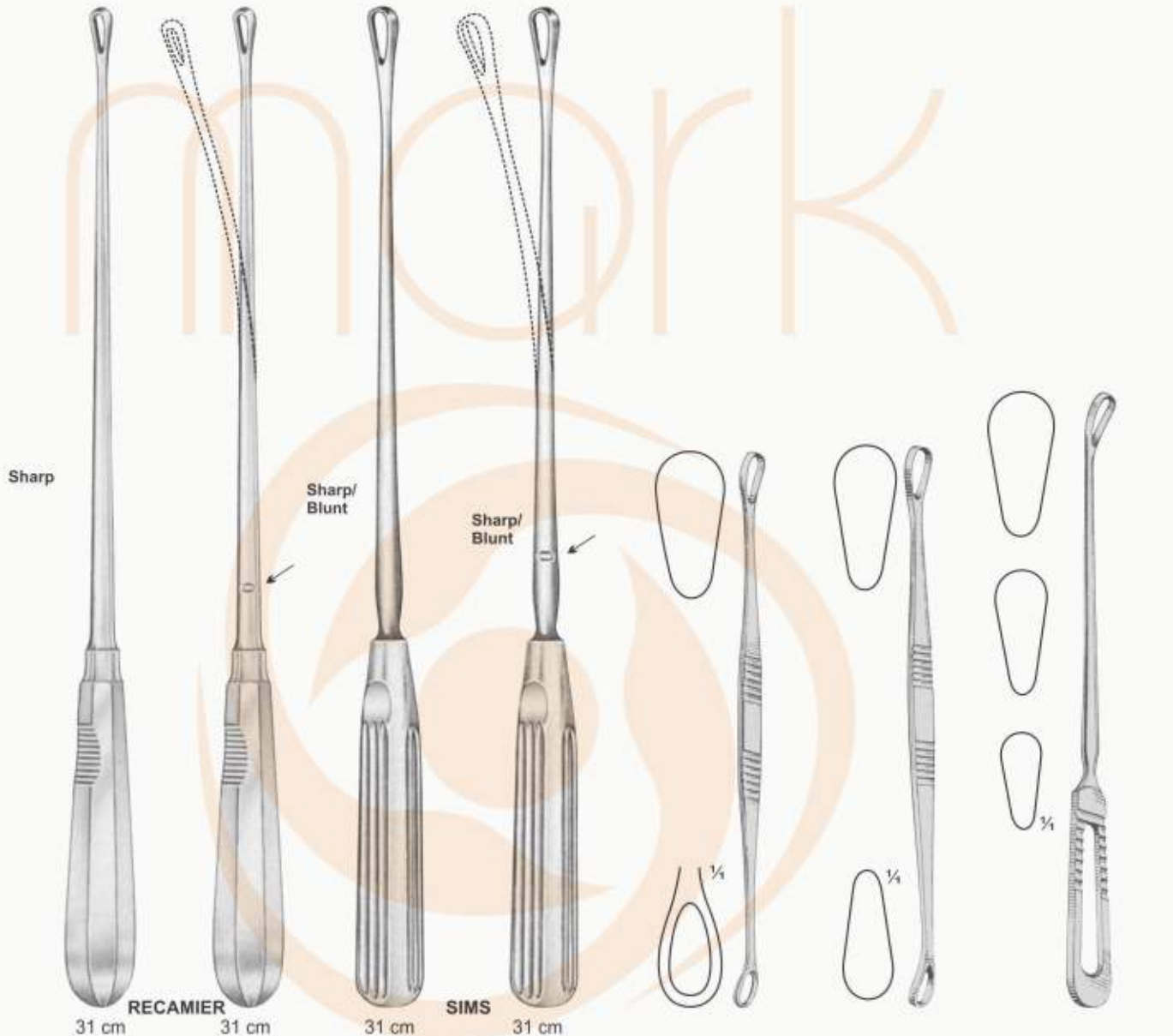

5.0 mm	14-139-310	14-153-310	14-167-310	14-181-310
6.0 mm	14-140-310	14-154-310	14-168-310	14-182-310
7.0 mm	14-141-310	14-155-310	14-169-310	14-183-310
8.0 mm	14-142-310	14-156-310	14-170-310	14-184-310
9.0 mm	14-143-310	14-157-310	14-171-310	14-185-310
11.0 mm	14-144-310	14-158-310	14-172-310	14-186-310
12.0 mm	14-145-310	14-159-310	14-173-310	14-187-310
14.0 mm	14-146-310	14-160-310	14-174-310	14-188-310
15.0 mm	14-147-310	14-161-310	14-175-310	14-189-310
16.0 mm	14-148-310	14-162-310	14-176-310	14-190-310
19.0 mm	14-149-310	14-163-310	14-177-310	14-191-310
20.0 mm	14-150-310	14-164-310	14-178-310	14-192-310
21.0 mm	14-151-310	14-165-310	14-179-310	14-193-310
23.0 mm	14-152-310	14-166-310	14-180-310	14-194-310

SIMS UTERINE 14-195-250
single ended, sharp blunt
25 cm three sizes small, medium, large

SIMS UTERINE 14-196-250
double ended, sharp 25 cm long.

SIMS UTERINE 14-197-250
sharp and blunt ends.
25 cm long.

BIOPSY CURETTES, ASPIRATING CURETTES

Biopsieküretten, Absaugküretten

Curettes pour biopsie, Curettes d'aspiration

Curetas de aspiración

Curette per aspirazione



RANDALL
 14-198-240
 24 cm



SHARMAN
 14-199-230
 23 cm



RHEINSTATER
 14-200-290 29 cm Sharp
 14-201-290 29 cm Blunt



**GALABIN
 UTERINE
 SOUND**
 14-202-292
 malleable, shaft
 graduated in cms.
 Silver plated,
 29.2 cm



**HORROCKS
 UTERINE
 SOUND**
 14-203-001
 malleable, shaft
 graduated in cms.
 Silver plated,



**NOVAK "SUCTION
 CANNULA
 CURETTE"**
 14-204-254
 Luer cone,
 25.4 cm

INSTRUMENTS

UTERINE SOUNDS

INSTRUMENTS

Uterus-Sonden

Hystéromètres du col de l'utérus

Histerómetros uterinos

Isterometri uterini



SIMS
 14-205-320
 32 cm
 right
 malleable



SIMPSON
 schwed. Modell
 14-206-260
 26 cm



MARTIN
 14-207-300
 30 cm



VALLEIX
 14-208-250
 25 cm

ABORTION FORCEPS - OVUM CURETTES

Abortuszangen - Abortusküretten

Pinces à faux germes - Curette d'avortement

Pinzas para abort - Curetas para aborto

Pinze per placenta ed aborto - Curette per placenta ed aborto



WINTER
14-209-280 Fig. 1
14-210-280 Fig. 2
14-211-280 Fig. 3
28 cm

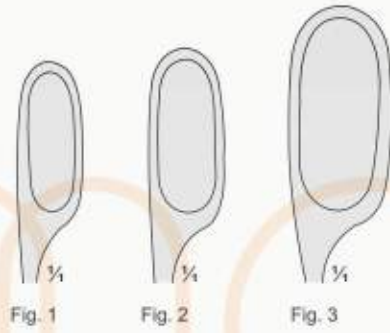

WINTER
14-312-280 Fig. 1
14-213-280 Fig. 2
14-214-280 Fig. 3
28 cm



SAENGER
27 cm

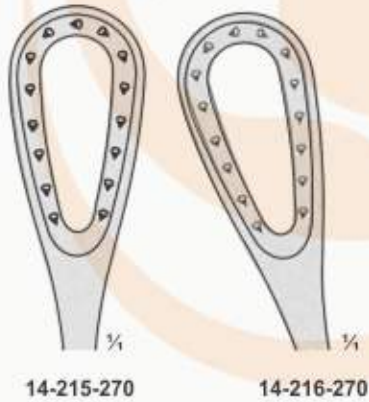

GREEN-ARMYTAGE
14-217-210
21 cm



WALLICH
14-218-350 35 cm
14-219-420 42 cm

UTERINE SOUNDS

INSTRUMENTS

Uterus-Sonden

Histerómetros uterinos

Hystéromètres du col de l'utérus

Isterometri uterini



PRATT DILATOR



PRATT DILATORS

14-220-001

Set of 8 Double ended
 size 13/14 thru 41/43
 4.5/5.0mm thru 13.6/14.3mm

14-221-001	04.5/05.0 mm
14-222-002	05.6/06.3 mm
14-223-003	07.0/07.6 mm
14-224-004	08.3/09.0 mm
14-225-005	09.6/10.3 mm
14-226-006	11.0/11.6 mm
14-227-007	12.3/13.0 mm
14-228-008	13.6/14.3 mm



HEGAR DILATORS

14-229-001

Set of 8 dilator
 3.0/4.0 mm - 17.0/18.0 mm

14-230-002

Set of 13 dilator
 1.0/2.0 mm - 25.0/26.0 mm



HANK

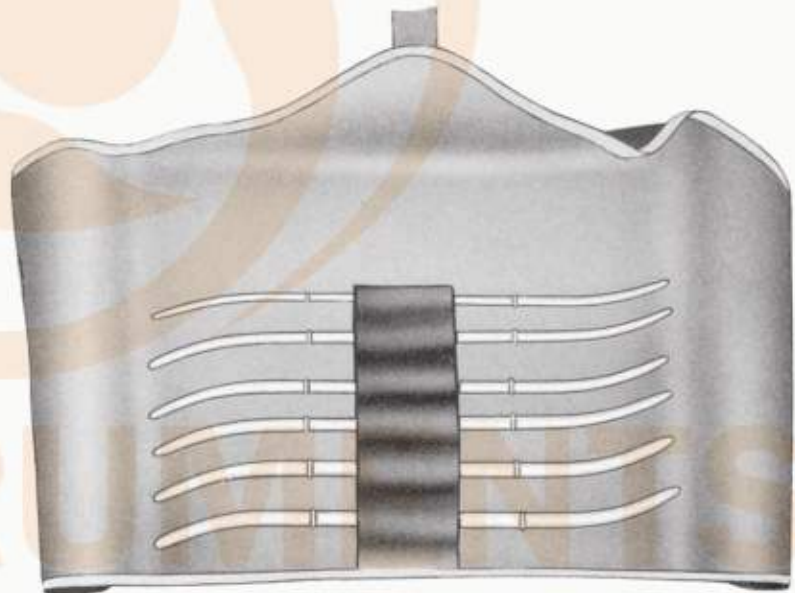

HANK DILATORS

14-237-001

Set of 6 dilators
 4.5/5.0 mm - 9.5/10.0 mm

14-231-001	4.5/05.0 mm
14-232-002	5.5/06.0 mm
14-233-003	6.5/07.0 mm
14-234-004	7.5/08.0 mm
14-235-005	8.5/09.0 mm
14-236-006	9.5/10.0 mm

UTERINE SOUNDS

INSTRUMENTS

Uterus-Sonden

Histerómetros uterinos

Hystéromètres du col de l'utérus

Isterometri uterini



14-238-001
 Set of 8 dilators
 3.0/4.0 mm - 17.0/18.0 mm
14-239-002
 Set of 13 dilators
 1.0/2.0 mm - 25.0/26.0 mm

HEGAR DILATOR



- 14-253-001 1 mm
- 14-254-002 2 mm
- 14-255-003 3 mm
- 14-256-004 4 mm
- 14-257-005 5 mm
- 14-258-006 6 mm
- 14-259-007 7 mm
- 14-260-008 8 mm
- 14-261-009 9 mm
- 14-262-010 10 mm
- 14-263-011 11 mm
- 14-264-012 12 mm
- 14-265-013 13 mm
- 14-266-014 14 mm
- 14-267-015 15 mm
- 14-268-016 16 mm
- 14-269-017 17 mm
- 14-270-018 18 mm
- 14-271-019 19 mm
- 14-272-020 20 mm
- 14-273-021 21 mm
- 14-274-022 22 mm
- 14-275-023 23 mm
- 14-276-024 24 mm
- 14-277-025 25 mm
- 14-278-026 26 mm
- 14-279-027 27 mm
- 14-280-028 28 mm
- 14-281-029 29 mm
- 14-282-030 30 mm

14-284-001
 Set of 14 dilators
 4.0 mm - 17.0 mm

- 14-285-001 1.5 mm
- 14-286-002 2.5 mm
- 14-287-003 3.5 mm
- 14-288-004 4.5 mm
- 14-289-005 5.5 mm
- 14-290-006 6.5 mm
- 14-291-007 7.5 mm
- 14-292-008 8.5 mm
- 14-293-009 9.5 mm
- 14-294-010 10.5 mm
- 14-295-011 11.5 mm
- 14-296-012 12.5 mm
- 14-297-013 13.5 mm
- 14-298-014 14.5 mm
- 14-299-015 15.5 mm
- 14-300-016 16.5 mm
- 14-301-017 17.5 mm
- 14-302-018 18.5 mm
- 14-303-019 19.5 mm

HEGAR DILATOR

14-283-001
 Set of 26 dilators
 1.0 mm - 26.0 mm



HEGAR DILATORS

14-304-001
 Set of 14 dilators
 4.0 mm - 17.0 mm

INSTRUMENTS

CERVICAL BIOPSY AND SPECIMEN FORCEPS

Probeexzisionszangen

Pinzas saca-bocados para biopsia

Pinces emporte-pièces à biopsie

Pinze taglianti per biopsia



TISCHLER-KEVORKIAN
14-305-220
22 cm
with latch
3 x 9.5 mm

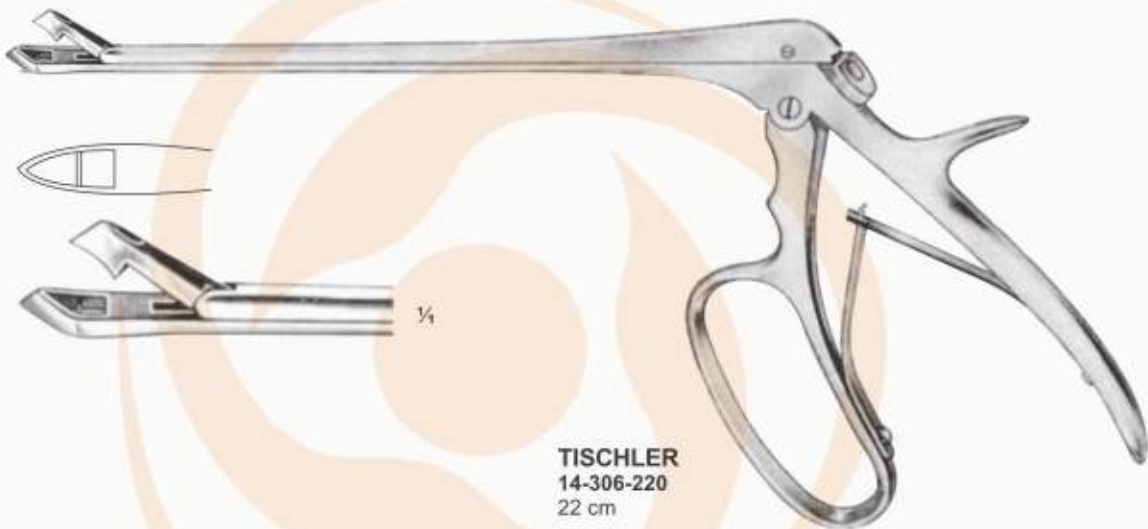

TISCHLER
14-306-220
22 cm

22.0 cm 8 1/2"



BURKE
14-307-220
22 cm
with latch
7 x 5 mm

CERVICAL BIOPSY AND SPECIMEN FORCEPS

Probeexzisionszangen

Pinzas saca-bocados para biopsia

Pinces emporte-pièces à biopsie

Pinze taglianti per biopsia



KEVORKIAN-PACIFIC
14-308-220
22 cm
with latch
3 x 8 mm

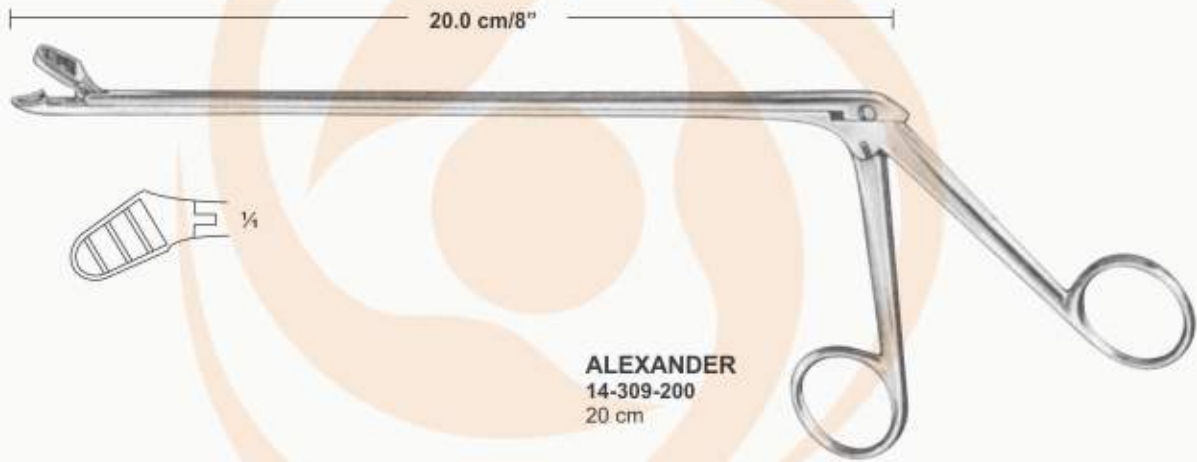

ALEXANDER
14-309-200
20 cm



SCHUMACHER
14-310-240 5 mm
14-311-240 7 mm

CERVICAL BIOPSY AND SPECIMEN FORCEPS

Probeexzisionszangen

Pinzas saca-bocados para biopsia

Pinces emporte-pièces à biopsie

Pinze taglianti per biopsia

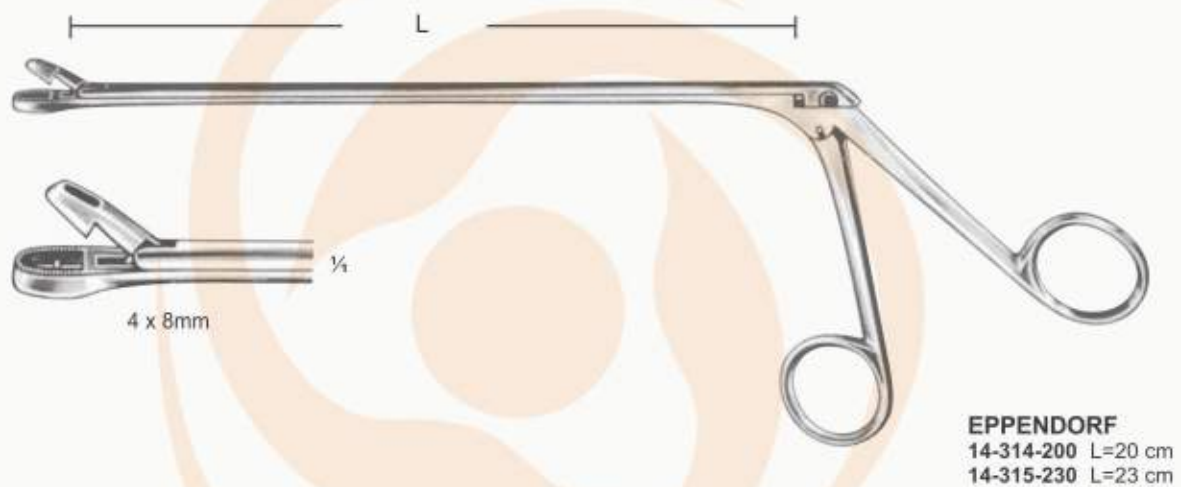
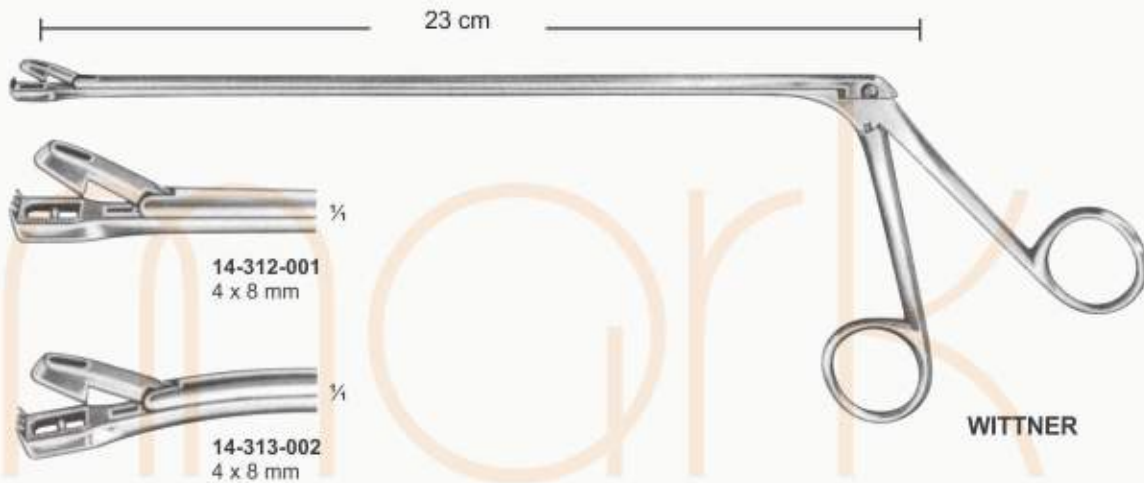

CERVICAL BIOPSY AND SPECIMEN FORCEPS

Probeexzisionszangen

Pinzas saca-bocados para biopsia

Pinces emporte-pièces à biopsie

Pinze taglianti per biopsia

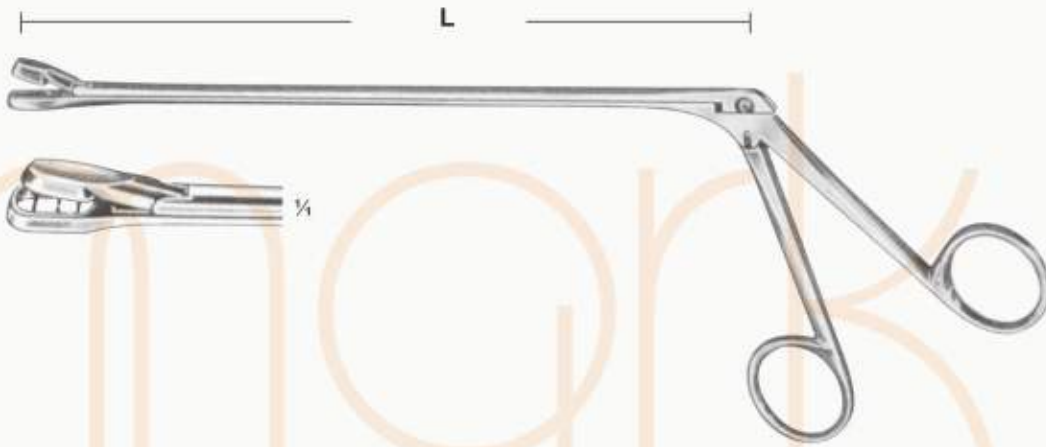

DOUAY

14-317-200	L=20 cm
14-318-250	L=25 cm
14-319-300	L=30 cm
14-320-350	L=35 cm
14-321-400	L=40 cm



TISCHLER
14-322-250



KEVORKIAN
14-323-250



EPPENDORF
14-324-250



14-322-001



MINI-TOWNSEND
14-325-250

CERVICAL BIOPSY AND SPECIMEN FORCEPS

INSTRUMENTS

Probeexzisionszangen

Pinzas saca-bocados para biopsia

Pinces emporte-pièces à biopsie

Pinze taglianti per biopsia



14-326-200
 20 cm
 With Fixing Screw
 2.3 x 4.2 mm
14-327-200
 20 cm
 Without Fixing Screw
 2.3 x 4.2 mm

TISCHLER



14-328-220
 22 cm
 3 x 7 mm

TISCHLER-
 MORGAN



14-329-230
 23 cm
 3 x 9.7 mm
14-330-250
 25 cm
 3 x 9.7 mm

KEVORKIAN

CERVICAL BIOPSY AND SPECIMEN FORCEPS

INSTRUMENTS

Probeexzisionszangen

Pinzas saca-bocados para biopsia

Pinces emporte-pièces à biopsie

Pinze taglianti per biopsia



GELLHORN
 14-331-230
 23 cm



FAURE
 14-332-230
 23 cm



SCHUBERT
 14-333-210 21 cm
 14-334-280 28 cm



THOMS-GAYLOR
 14-335-240
 24 cm



SCHUBERT
 14-336-260
 26 cm



VAN DOREN
 14-337-250
 25 cm



VAN DOREN
 14-338-250
 25 cm



NAEGELE
 14-339-250
 25 cm



SPELLIE
 14-340-250
 25 cm



BRAUN
 14-341-300
 30 cm



SPELLIE
 14-342-300
 30 cm

PELVIMETER, OBSTETRICAL FORCEPS

Beckenzirkel, Geburtszangen Pelvímetro, Forceps obstétricos
 Pelvimètre, Forceps obstétriques Pelvimetri, Forcipi obstetrici



MARTIN
 14-343-340
 34 cm



COLLIN
 14-344-350
 35 cm



PIPER
 14-345-440
 44 cm



NAEGELE
 14-346-360 36 cm
 14-347-400 40 cm



SIMPSON
 14-348-300
 30 cm



SIMPSON-BRAUN
 14-349-260 33 cm
 14-350-260 38 cm



MCLEAN
 14-351-260
 36 cm



KIELLAND
 14-352-410
 41 cm

OBSTETRICAL FORCEPS

INSTRUMENTS

Geburtszangen

Forceps obstétricos

Forceps obstétricus

Forcipi



KIELLAND-LUIKART
 14-353-410
 41 cm



WRIGLEY
 14-354-230
 23 cm



DE LEE
 14-355-300
 30 cm

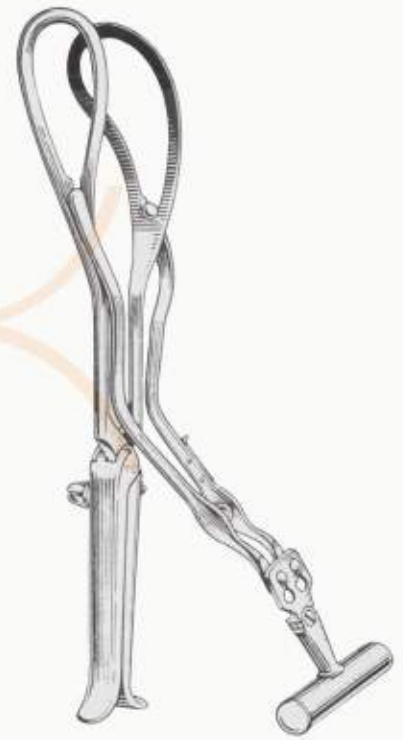

MILNE MURRAY
 14-356-001
 detach-able axis traction
 rod & handle.

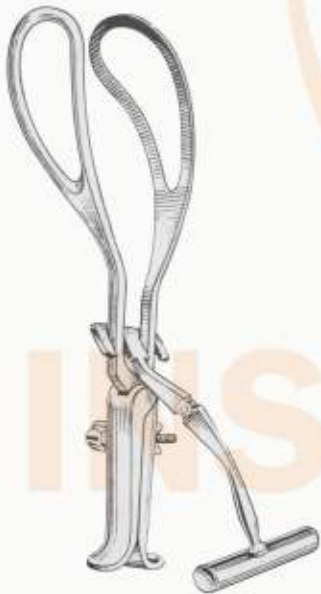

HAIG FERGUSON
 14-357-001
 detachable axis traction
 rod & handle.



BARNES-NEVILLE
 14-358-001
 Simpson handles, detachable
 axis traction rod and handle.



BRAUN
 14-359-420
 42 cm



TARNIER
 14-360-440
 44 cm

SECTION - 15

UROLOGY

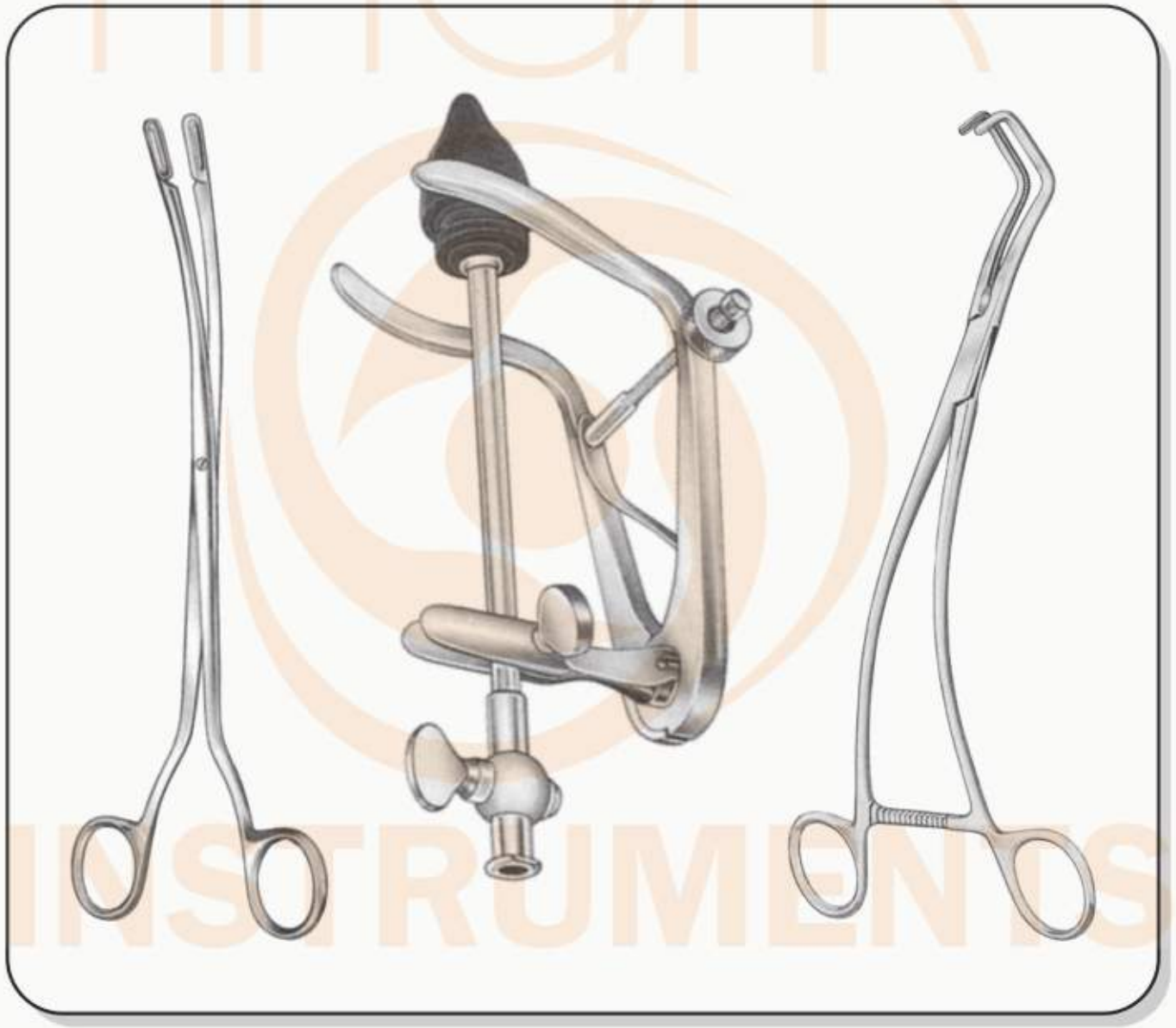

KIDNEY STONE FORCEPS

Nierensteinzangen

Pinces pour les calculs du bassin

Pinzas para cálculoa renales

Pinze per calcoli renali



COLLIN
15-001-265
26.5 cm



DARTIGUES
15-002-270
27 cm



COLLIN
15-003-285
28.5 cm



HULKA-KENWICK
15-004-273
27.3 cm



RANDALL

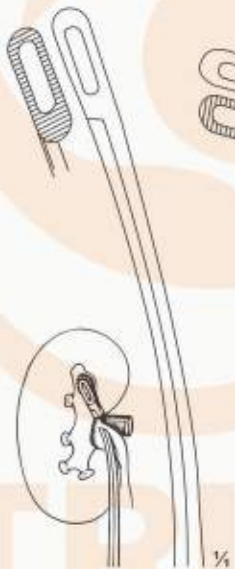

15-005-230
23 cm



15-006-230
23 cm

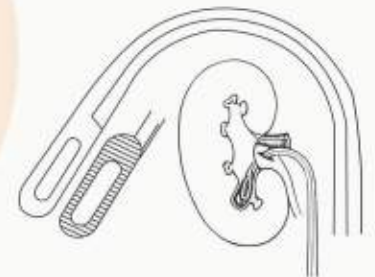

15-007-230
23 cm

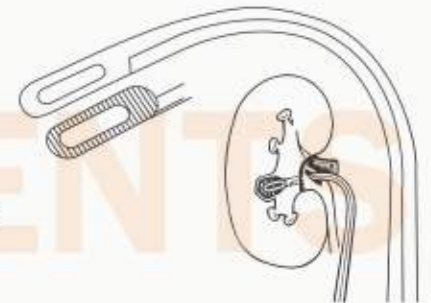

15-008-230
23 cm

GALL STONE FORCEPS

Gallensteinzangen Pincers pour calculs biliaires
 Gallensteinlöffel Curettes pour calculs biliaires



BLAKE



BLAKE



MAYO-BLAKE



MAYO-BLAKE



MIXTER



DESJARDINS



DESJARDINS



URO-TANGENTIAL



15-016-260
26 cm

15-017-260
26 cm

LIGATURE CARRYING FORCEPS

Fadenführungszange
Pinza porta ligaduras

Pince porte-fil
Pinza porta-filo



MILLIN
15-018-240
24 cm



MILLIN
15-019-230
23 cm



MILLIN
15-020-230
23 cm



MILLIN
15-021-230
23 cm

PROSTATIC RETRACTOR

INSTRUMENTS

Prostatahaken
 Separadores para próstata

Ecarteurs prostatiques
 Divaricatori prostatici

11 x 50 mm

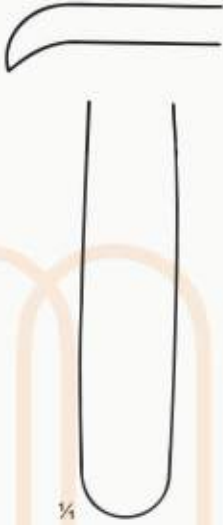

YOUNG
 15-022-210
 21 cm

38 x 64 mm

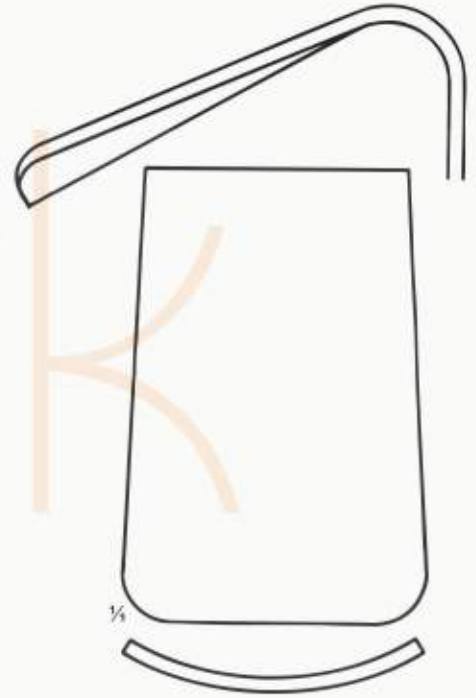

YOUNG
 15-023-220
 22 cm

25 x 25 mm



YOUNG
 15-024-210
 21 cm

39 x 35 mm



YOUNG
 15-025-220
 22 cm

INSTRUMENTS

GALL DUCT DILATOR

Gallenkanaldilatatore
Gallensteinzangen

Dilatateurs pour les voies biliaires
Pincés pour calculs biliaires

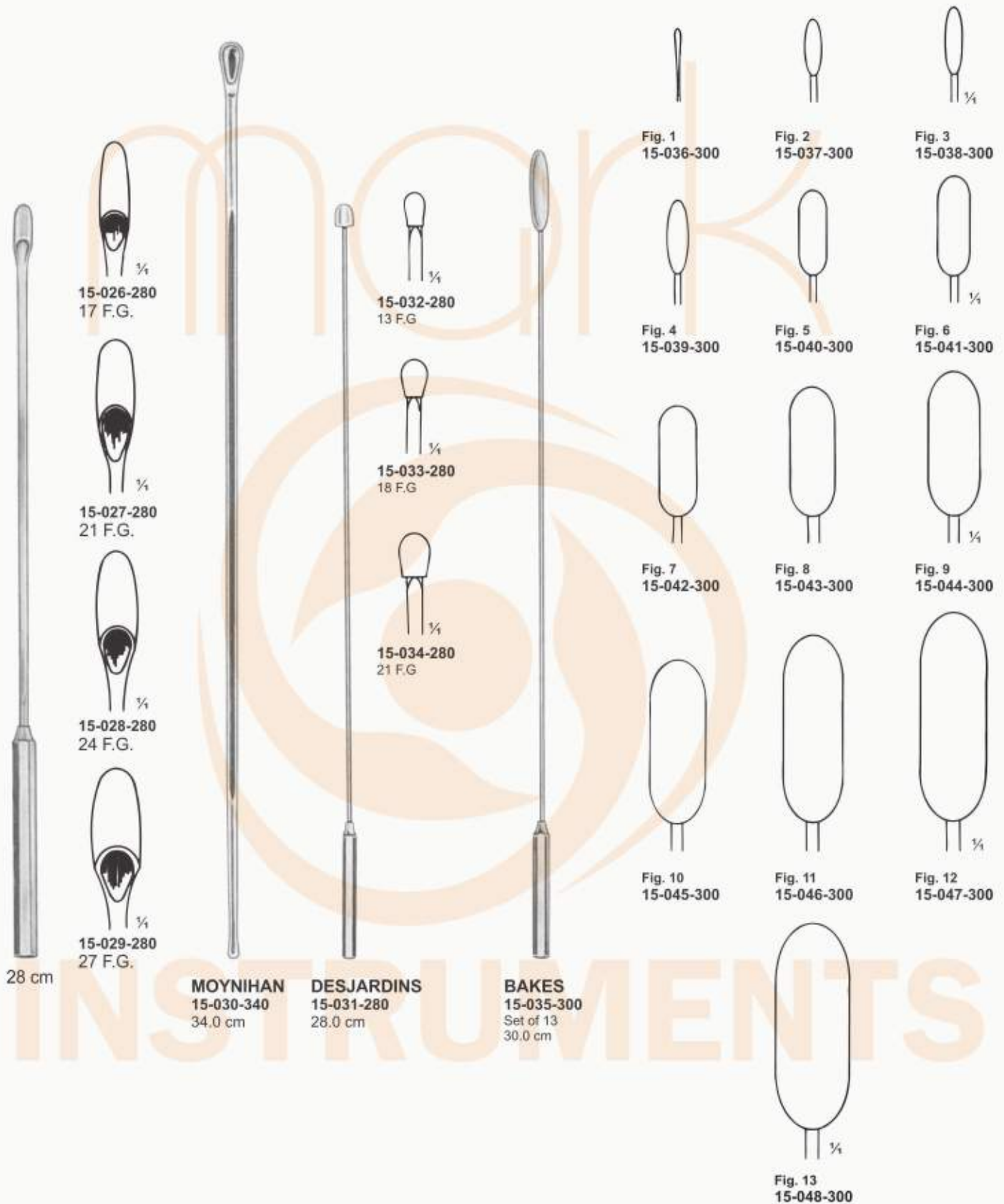

URETHRAL CATHETERS

Urethral catheter Cateteri Uretrali
Sondes Urétrales Catéteres Uretrales



CATHETER
15-049-265
26.5 cm
14 Fr



CATHETERS
15-050-290 29 cm
Male Catheters, metal

	French
15-051-01	8
15-052-02	10
15-053-03	12
15-054-04	14
15-055-05	16
15-056-06	18
15-057-07	20



LISTER BOUGIES
15-058-270
27 cm
00 / 1 to 15 / 18
set of 17



CLUTTON BOUGIES
15-059-270
27 cm
06 / 10 to 28 / 32
set of 12



VAN BUREN
A TO O
Set of 15

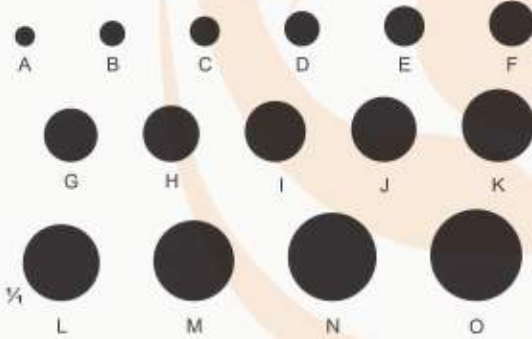

Fig.	Item	Description	Dia.
A	15-060-280	28 cm	8 French
B	15-061-280	28 cm	10 French
C	15-062-280	28 cm	12 French
D	15-063-280	28 cm	14 French
E	15-064-280	28 cm	16 French
F	15-065-280	28 cm	18 French
G	15-066-280	28 cm	20 French
H	15-067-280	28 cm	22 French
I	15-068-280	28 cm	24 French
J	15-069-280	28 cm	26 French
K	15-070-280	28 cm	28 French
L	15-071-280	28 cm	30 French
M	15-072-280	28 cm	32 French
N	15-073-280	28 cm	34 French
O	15-074-280	28 cm	36 French



GUYON BOUGIES
15-075-270
27 cm
Without thread



GUYON BOUGIES SET
15-076-00
420 x 175 x 40 mm
Set in metal case containing:
— 21 Bougies Guyon
— 6 filiform Bougies

REVERDIN NEEDLES

Reverdín nadeln
 agujas de reverdín

Aguilles de reverdín
 aghi di reverdín



**THOMSON-WALKER'S
 PENILE CLAMPS**
 15-078-00
 Cross-Action model.



MILLIN'S SUCTION TUBE
 15-079-00
 chromium-plated,
 with sliding "on & off"
 action.



YOUNG-HRYNTSCHAK
 15-080-200
 24 cm
 with 1 needle



15-082-200
 Spare needle



15-083-200
 Spare needle



15-084-200
 Spare needle



YOUNG-MILLN
 15-081-200
 20 cm
 with 1 needle

BLADDER NECK SPREADER, BLADDER RETRACTORS

Blasenhalsperrer, Blasenwundsperrer

Dilatador para el cuello vesical, Separadores vesicales

Ecarteur pour le col de la vessie, Ecarteurs vésicaux

Divaricatore del collo vescicale, Divaricatore vescicale

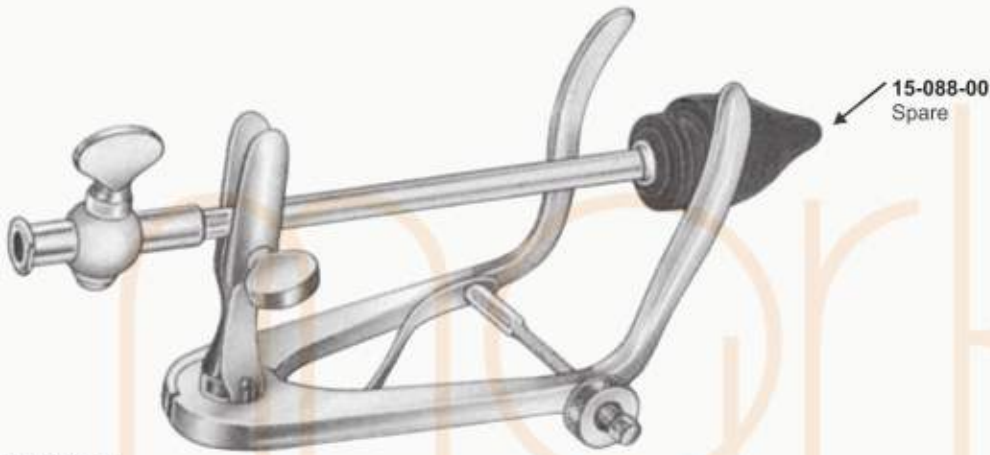

KNUTSON

15-085-180

18 cm

Urethrographie-Instruments

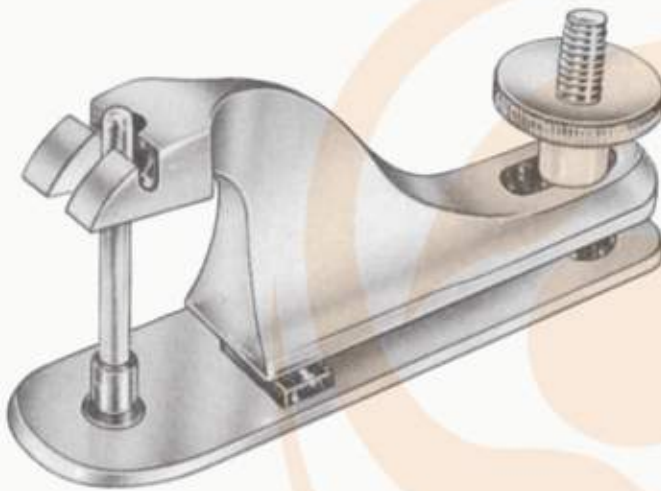

GUMCO CLAMP

mm Ø

15-086-00	8
15-087-00	11
15-088-00	13
15-089-00	16
15-090-00	21
15-091-00	26
15-092-00	32

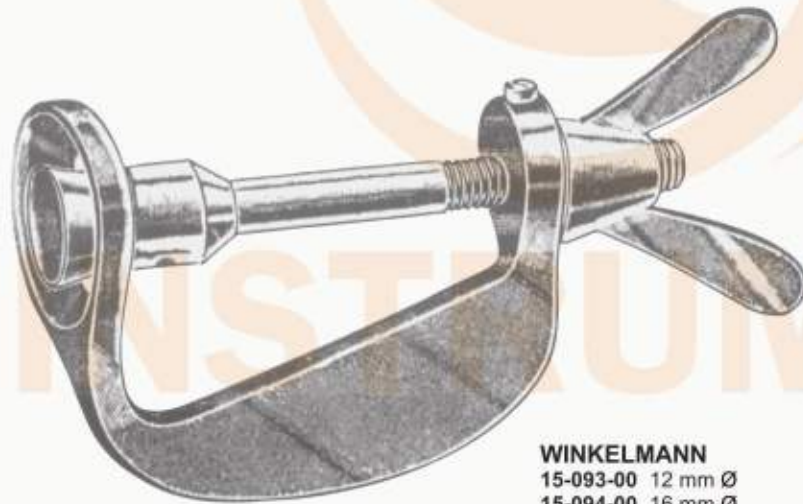

WINKELMANN

15-093-00 12 mm Ø

15-094-00 16 mm Ø

15-095-00 20 mm Ø

Circumcision clamps



MILLIN

15-096-280

28 cm

BLADDER NECK SPREADER, BLADDER RETRACTORS

INSTRUMENTS

Blasenhalsperrer, Blasenwundsperrer
 Dilatador para el cuello vesical, Separadores vesicales

Ecarteur pour le col de la vessie, Ecarteurs vésicaux
 Divaricatore del collo vescicale, Divaricatore vescicale

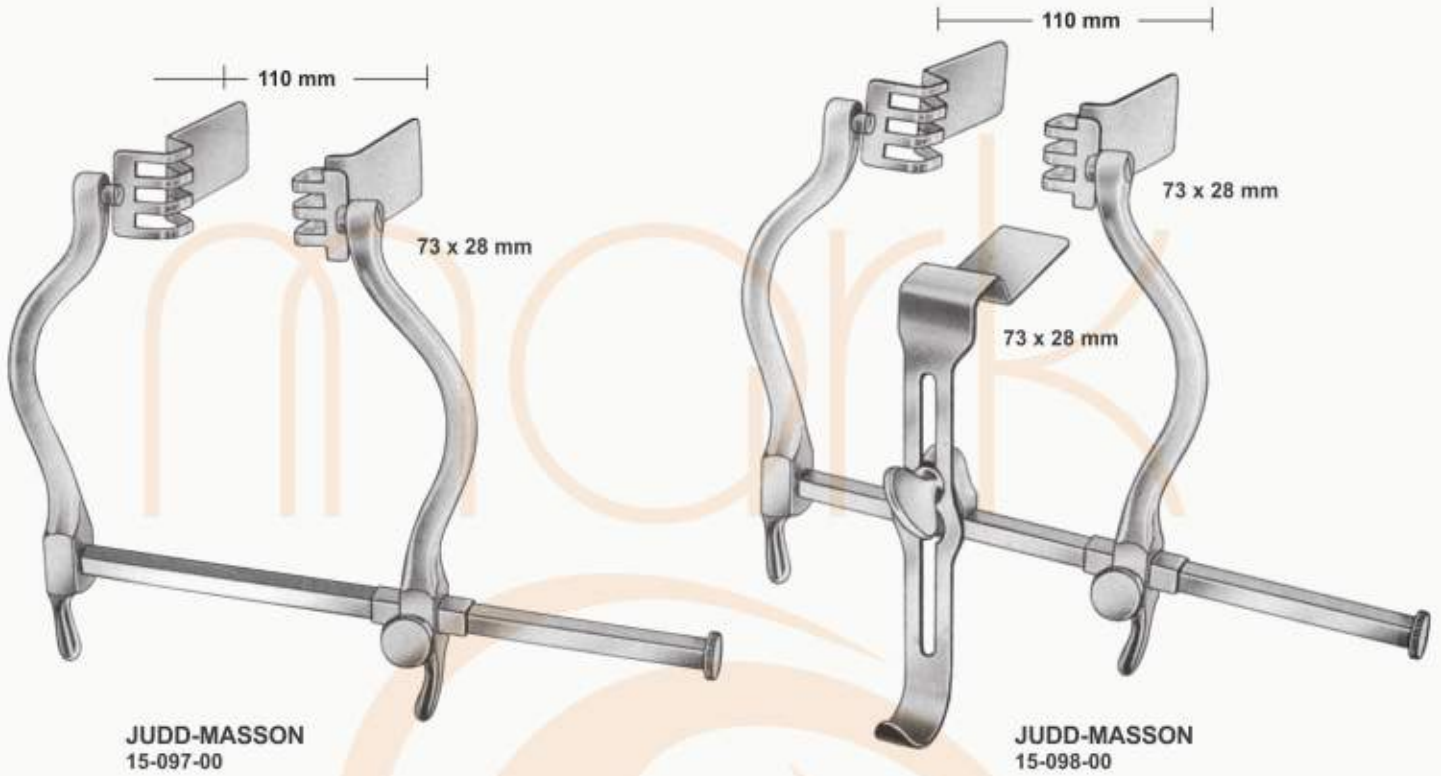

SECTION - 16

HOLLOWWARES





STERILIZING DRUMS

Sterilisieren Schlagzeug

Tambours de stérilisation

Tambores de esterilización

Tamburi di sterilizzazione



STERILIZING DRUMS

	Ø	h
	mm	mm
16-001-001	80	80
16-002-002	120	120
16-003-003	160	120
16-004-004	190	140
16-005-005	190	200
16-006-006	240	120
16-007-007	240	160
16-008-008	240	240
16-009-009	290	120
16-010-010	290	160
16-011-011	290	240
16-012-012	340	160
16-013-013	340	240
16-014-014	390	145
16-015-015	390	200
16-016-016	390	290

INSTRUMENTS

HOLLOWARE INSTRUMENTS

Hohlware Instrumenten
Orfebrería Instrumentos

orfèvrerie de Instruments de
Holloware Gli strumenti



NEEDLE BOX
16-017-00
150 x 95 x 13 mm



NEEDLE BOX
16-018-00
150 x 95 x 13 mm



NEEDLE BOX
16-019-00
150 x 95c x 13 mm



NEEDLE BOX
16-020-00
210 x 125 x 17 mm



STERILIZING CASE
16-021-00 50 x 25 x 4.5 mm
16-022-00 65 x 42 x 8 mm
16-023-00 75 x 25 x 4.5 mm



STERILIZING CASE
16-024-00 65 mm Ø x 15 mm
complete
16-025-00 62 mm Ø x 13 mm
insert only



STERILIZING CASE
16-026-00 50 x 25 x 4.5 mm
16-027-00 65 x 42 x 8 mm
16-028-00 75 x 25 x 4.5 mm

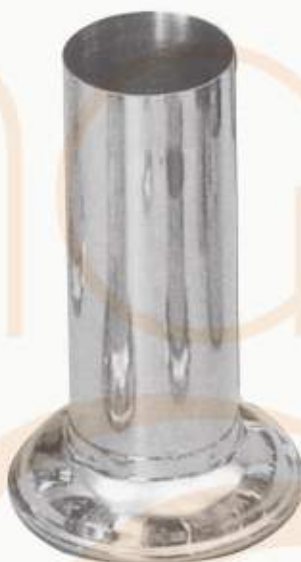

FORCEPS JAR

	Ø x H mm
16-029-001	30 x 90
16-030-002	50 x 100
16-031-003	50 x 120
16-032-004	50 x 160
16-033-005	50 x 180
16-034-006	50 x 200
16-035-007	60 x 150
16-036-008	80 x 130
16-037-009	80 x 175



GALIPOTS

	Ø x H mm	
16-038-001	40 x 30 mm	1 oz
16-039-002	50 x 35 mm	2 oz
16-040-003	55 x 40 mm	3 oz
16-041-004	65 x 45 mm	4 oz
16-042-005	70 x 50 mm	6 oz
16-043-006	85 x 60 mm	9 oz
16-044-007	105 x 60 mm	12 oz

WASH BASIN

	Ø x H mm	
16-045-001	270 x 85 mm	3.0 L
16-046-002	320 x 90 mm	4.0 L
16-047-003	360 x 100 mm	5.5 L

LOTION BOWLS

16-048-001	4"
16-049-002	6"
16-050-003	8"
16-051-004	10"
16-052-005	12"

HOLLOWWARE INSTRUMENTS

Hohlware Instrumenten orfèvererie de Instruments de
Orfebrería Instrumentos Holloware Gli strumenti



ENEMA CANE

16-053-01 1.0 Ltr.
16-054-02 1.5 Ltr.
16-055-03 2.0 Ltr.



FURNAL

16-056-001 50 x 90 mm
16-057-002 80 x 115 mm
16-058-003 100 x 125 mm
16-059-004 120 x 145 mm
16-060-005 150 x 190 mm
16-061-006 200 x 220 mm
16-062-007 250 x 260 mm



SPUTUM MUG

16-063-001 0.41
85 x 85 mm

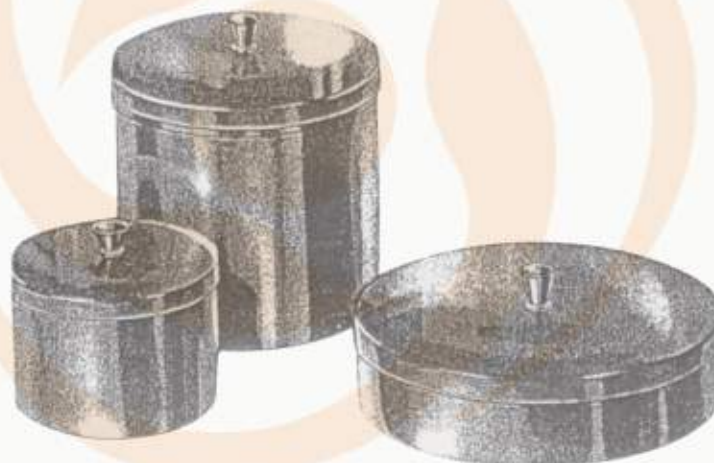

COTTON JARS

16-064-001	60 x 60 mm	0.151
16-065-002	85 x 50 mm	0.21
16-066-003	85 x 85 mm	0.41
16-067-004	100 x 50 mm	0.351
16-068-005	100 x 100 mm	0.71
16-069-006	100 x 150 mm	1.151
16-070-007	100 x 200 mm	1.41
16-071-008	120 x 120 mm	1.21
16-072-009	150 x 100 mm	1.61
16-073-010	150 x 150 mm	2.51
16-074-011	200 x 100 mm	3.01
16-075-012	200 x 200 mm	6.01

INSTRUMENTS



HOLLOWARE INSTRUMENTS

Hohlware Instrumenten

orfèvrerie de Instruments de

Orfebrería Instrumentos

Holloware Gli strumenti



KIDNEY DISHES

16-073-001	15 cm	0.3 L
16-074-002	20 cm	0.5 L
16-075-003	25 cm	0.8 L
16-076-004	30 cm	1.1 L



INSTRUMENT TRAYS

16-077-001	8 x 6 x 40 mm
16-078-002	10 x 8 x 40 mm
16-079-003	12 x 10 x 40 mm
16-080-004	14 x 12 x 40 mm
16-081-005	220 x 170 x 50 mm
16-082-006	280 x 200 x 50 mm
16-083-007	320 x 240 x 50 mm
16-084-008	370 x 270 x 50 mm
16-085-009	420 x 320 x 50 mm



INSTRUMENT BOX WITH CLIPS

16-086-001	180 x 80 x 40 mm
16-087-002	200 x 100 x 60 mm
16-088-003	220 x 120 x 60 mm
16-089-004	250 x 120 x 60 mm
16-090-005	300 x 125 x 60 mm
16-091-006	320 x 150 x 60 mm
16-092-007	400 x 160 x 75 mm
16-093-008	500 x 200 x 120 mm

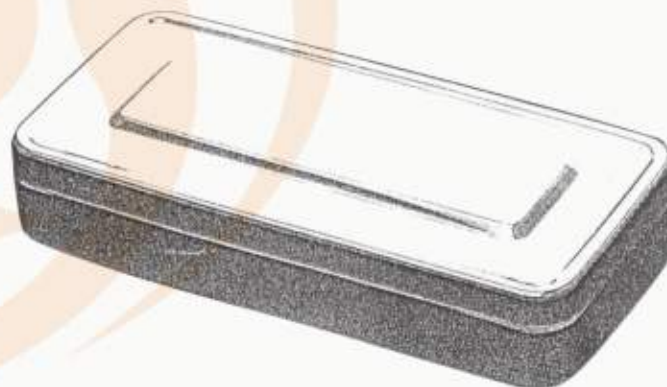

INSTRUMENT BOX WITH CLIPS

16-094-001	180 x 80 x 40 mm
16-095-002	200 x 100 x 60 mm
16-096-003	220 x 120 x 60 mm
16-097-004	250 x 120 x 60 mm
16-098-005	300 x 125 x 60 mm
16-099-006	320 x 150 x 60 mm
16-100-007	400 x 160 x 75 mm
16-101-008	500 x 200 x 120 mm

HOLLOWWARE INSTRUMENTS

Hohlware Instrumenten
Orfebrería Instrumentos

orfèvrerie de Instruments de
Holloware Gli strumenti



URINAL MALE
16-102-00



URINAL FEMALE
16-103-00



BED PANS
16-104-00
350 x 290 x 10 mm



BED PANS
16-105-00
350 x 290 x 100 mm



FLAT TYPE WITH HANDLE
16-106-00
360 x 255 x 90 mm
Feature Bed Pan

PERFORATED BASKETS

perforiert Körbe paniers perforés
Cestas perforadas ceste forate

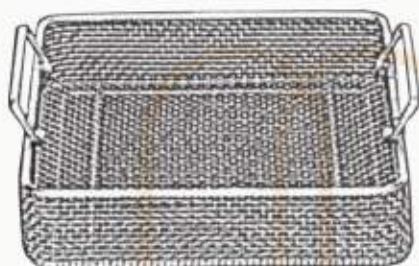

MESH BASKET

16-107-001 240 x 258 x 50 mm
16-108-002 250 x 240 x 100 mm
16-109-003 240 x 250 x 60mm

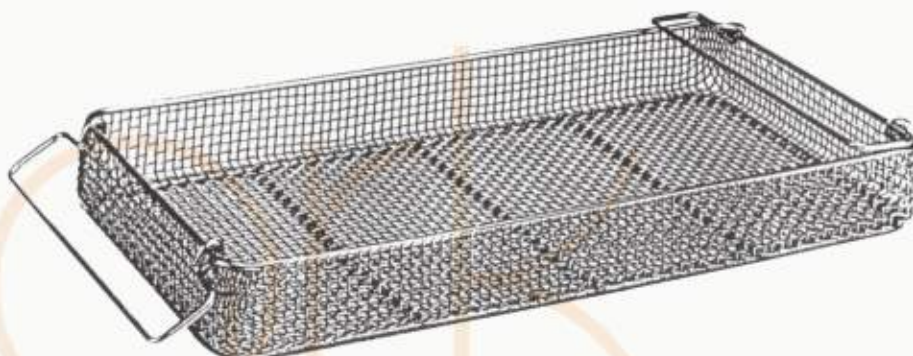

MESH BASKET

16-110-001 480 x 258 x 50 mm
16-111-002 480 x 258 x 100 mm
16-112-003 520 x 258 x 60mm
16-113-004 520 x 258 x 70mm
16-114-005 450 x 340 x 70mm
16-115-006 320 x 230 x 70mm

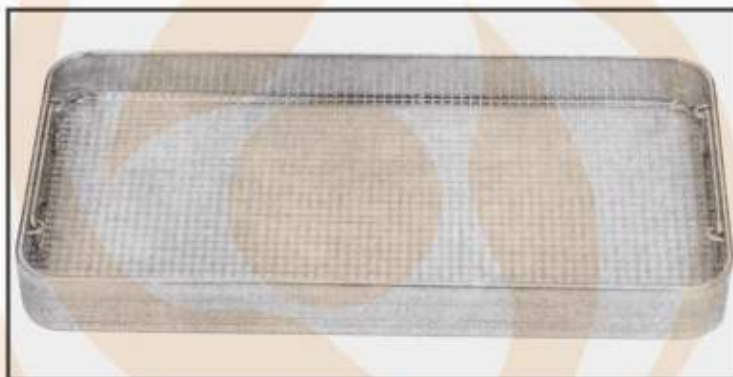

MESH BASKET

With Perforated Sheet Side

16-116-001 230 x 130 x 50 mm
16-117-002 230 x 130 x 60 mm
16-118-003 240 x 130 x 50 mm
16-119-004 240 x 130 x 60 mm
16-120-005 240 x 250 x 50 mm
16-121-006 240 x 250 x 60 mm
16-122-007 480 x 250 x 50 mm
16-123-008 480 x 250 x 60 mm
16-124-009 480 x 250 x 70 mm
16-125-010 300 x 300 x 50 mm
16-126-011 350 x 350 x 60 mm
16-127-012 470 x 400 x 60 mm
16-128-013 480 x 480 x 50 mm
16-129-014 480 x 480 x 60 mm
16-130-015 500 x 300 x 50 mm
16-131-016 520 x 300 x 50 mm
16-132-017 520 x 300 x 60 mm
16-133-018 550 x 430 x 50 mm
16-134-019 600 x 300 x 60 mm

INSTRUMENTS

PERFORATED BASKETS

perforiert Körbe *paniers perforés*
Cestas perforadas *ceste forate*

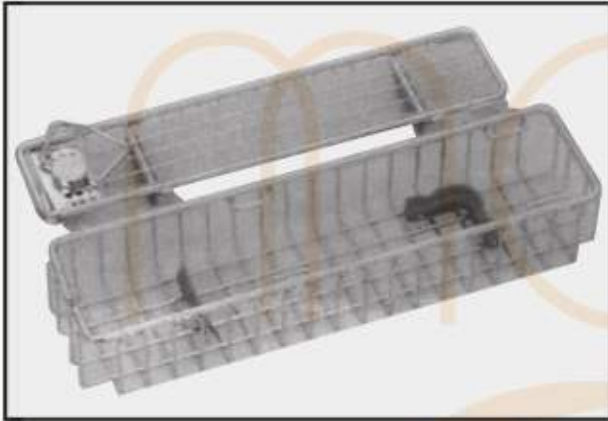

ARTHROSCOPE BASKET
16-135-00 290 x 80 x 52 mm

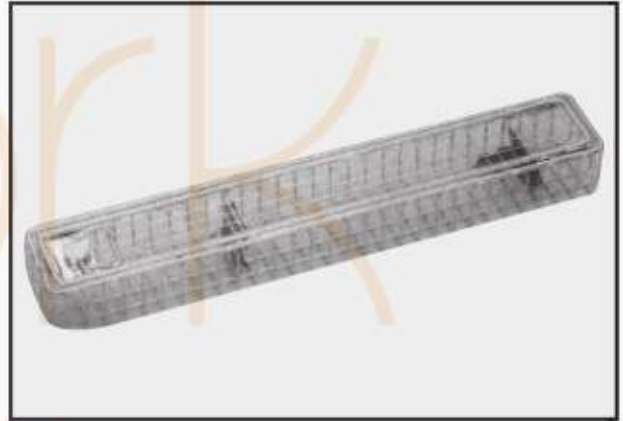

ENDOSCOPE BASKET
16-136-001 460 x 80 x 52 mm
16-137-002 660 x 80 x 52 mm
16-138-003 670 x 80 x 52 mm



TRINKET BOX
16-139-001 90 x 60 x 25 mm
16-140-002 105 x 70 x 25 mm
16-141-003 120 x 80 x 25 mm

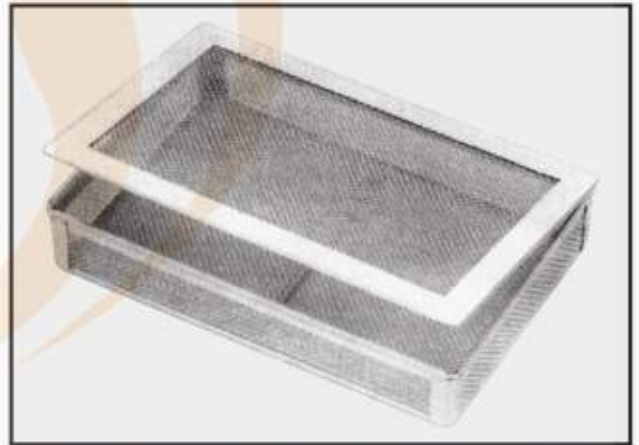

FINE MESH BASKET WITH LID
16-142-001 120 x 155 x 40 mm
16-143-002 235 x 155 x 40 mm
16-144-003 375 x 260 x 40 mm



MARK INSTRUMENTS (PVT) LTD.

Manufacturers and Exporters of High Class Surgical, Dental Instruments.

Registered office: 26/4-Zafar Ali Road, Sialkot-Cantt. 51310-Pakistan.

Tel: +92-52-4292513-19 (2 Lines), Fax: +92-52-4268742 Cell: +92-300-8612950

E-mail: info@markinstruments.com Web: www.markinstruments.com



CE MARK
Approved

