

DRESSING & TISSUE FORCEPS

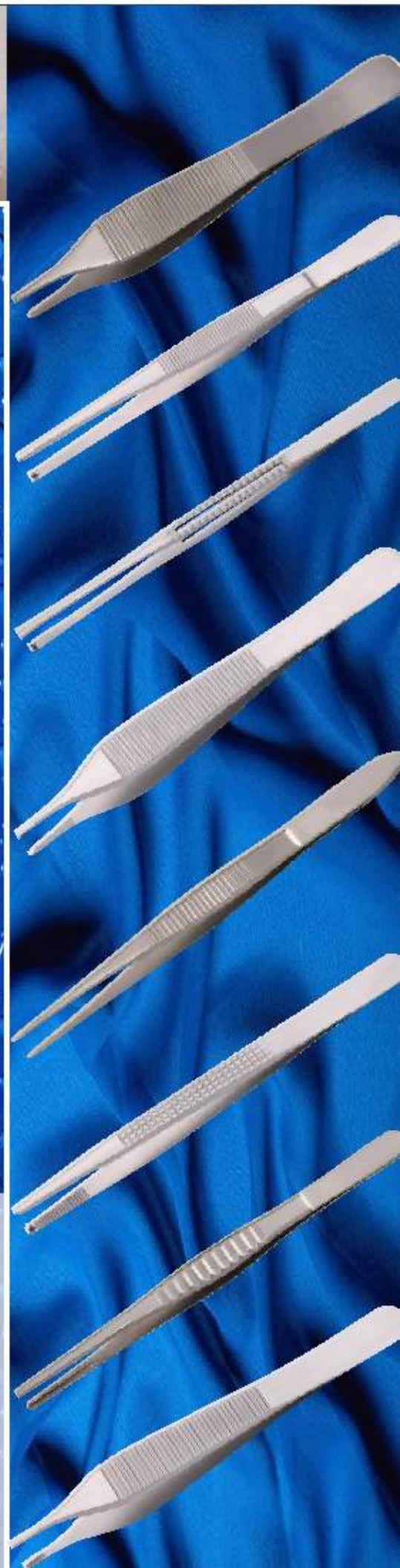

MARK INSTRUMENTS (PVT) LTD.

Manufacturers and Exporters of High Class Surgical, Dental Instruments.

Registered office: 26/4-Zafar Ali Road, Sialkot-Cantt. 51310-Pakistan.
Tel: +92-52-4292513-19 (2 Lines), Fax: +92-52-4268742 Cell: +92-300-8612950
E-mail: info@markinstruments.com Web: www.markinstruments.com

PHILOSOPHY

We are Specialist in Manufacturing all Sorts of High Quality Dressing, Dissecting, Tissue, Thumb, Cardiovascular, De-Bakay, Ophthalmic Forceps and Dental Tweezers. We have recognized our production system and certified as ISO-9001:2008, ISO-13485:2003, CE Marking and FDA-USA.

We have employed highly technical staff and under their supervision we made fault free instruments. We use high quality steel for our instruments and our instruments are passed through every necessary process of quality control.

We have the policy to provide our worthy customer.

1. High Quality Instruments
2. Competitive rates
3. Fastest possible delivery

MARK INSTRUMENTS (PVT) LTD.

Manufacturers and Exporters of High Class Surgical, Dental Instruments.

Address

Registered office: 26/4-Zafar Ali Road, Sialkot-Cantt. 51310-Pakistan.

Tel: +92-52-4292513-19 (2 Lines), Fax: +92-52-4268742

E-mail: info@markinstruments.com Web: www.markinstruments.com



DRESSING FORCEPS, TISSUE FORCEPS

Anatomische pinzetten, chirurgische pinzetten

Pincès à dissection, pincès à griffes

Pinzas de disección, pinzas de disección condientes

Pinze Anatomiche per dissezion, pinze chirurgiche a dentiditopo



STANDARD DRESSING FORCEPS



MJ-001
10.5 cm, 4 1/4"
serrated



MJ-002
11.5 cm, 4 1/2"
serrated



MJ-003
13 cm, 5"
serrated

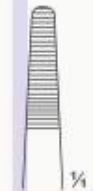

MJ-004
14.5 cm, 5 3/4"
serrated



MJ-005
16 cm 6 1/4"
serrated



MJ-006
18 cm, 7"
serrated



MJ-007
20 cm, 8"
serrated

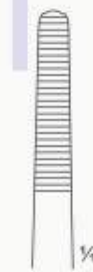

MJ-008
25 cm, 10"
serrated



MJ-009
30 cm, 12"
serrated



STANDARD TISSUE FORCEPS 1x2 teeth



MJ-010
10.5 cm, 4 1/4"



MJ-011
11.5 cm, 4 1/2"



MJ-012
13 cm, 5"



MJ-013
14.5 cm, 5 3/4"



MJ-014
16 cm 6 1/4"



MJ-015
18 cm, 7"



MJ-016
20 cm, 8"



MJ-017
25 cm, 10"



MJ-018
30 cm, 12"

Pinzas para tejidos, Pincas à dissection | Pincas a tissu, Anatomische pinzetten
Pinze per tessuti, Pinze per dissezione | Gewebe, Pinzas de disección

Mod. USA, Tissue Forceps

- 1x2 teeth
 MJ-019 10.2 cm, 4"
 MJ-020 11.4 cm, 4.5"
 MJ-021 12.7 cm, 5"
 MJ-022 14.0 cm, 5.5"
 MJ-023 15.2 cm, 6"
 MJ-024 17.8 cm, 7"
 MJ-025 20.3 cm, 8"
 MJ-026 25.4 cm, 10"
 MJ-027 30.5 cm, 12"



Mod. USA, Dressing Forceps serrated

- MJ-028 12 cm, 4 3/4"
 MJ-029 13 cm, 5"
 MJ-030 14.5 cm, 5 3/4"
 MJ-031 15.5 cm, 6"
 MJ-032 18 cm, 7"
 MJ-033 21 cm, 8 1/4"
 MJ-034 25 cm, 10"
 MJ-035 31 cm, 12 1/4"



MOD. MARTIN Dressing Forceps

- MJ-036 12.7 cm, 5"
 MJ-037 14.0 cm, 5.5"



Standard Dressing Forceps

- MJ-038 11.4 cm, 4.5"
 MJ-039 12.7 cm, 5"
 MJ-040 14.0 cm, 5.5"
 MJ-041 15.2 cm, 6"
 MJ-042 17.8 cm, 7"
 MJ-043 20.3 cm, 8"
 MJ-044 25.4 cm, 10"
 MJ-045 30.5 cm, 12"
 Curved, serrated



Standard Dressing Forceps

- wide pattern cross serration
 MJ-046 11.4 cm, 4.5"
 MJ-047 12.7 cm, 5"
 MJ-048 14.0 cm, 5.5"
 MJ-049 15.2 cm, 6"
 MJ-050 17.8 cm, 7"
 MJ-051 20.3 cm, 8"
 MJ-052 25.4 cm, 10"
 MJ-053 30.5 cm, 12"



Standard Dressing Forceps Narrow Point

- MJ-054 12.7 cm, 5" serrated
 MJ-055 14 cm, 5.5" serrated
 MJ-056 15.2 cm, 6" serrated
 MJ-057 17.8 cm, 7" serrated
 MJ-058 20.3 cm, 8" serrated
 MJ-059 25.4 cm, 10" serrated
 MJ-060 30.5 cm, 12" serrated



Pinzas para tejidos, Pincas à dissection | Pincas a tissu, Anatomische pinzetten
Pinze per tessuti, Pinze per dissezione | Gewebe, Pinzas de disección

SEMKEN
Dressing Forceps
MJ-061 12.5 cm, 5"
MJ-062 15.5 cm, 6"
straight serrated



SEMKEN
Dressing Forceps
MJ-063 12.5 cm, 5"
MJ-064 15.5 cm, 6"
curved serrated



POTTS-SMITH
Dressing Forceps
MJ-065 17.5 cm, 7"
MJ-066 21.0 cm, 8 1/4"
MJ-067 25.0 cm, 10"
straight serrated

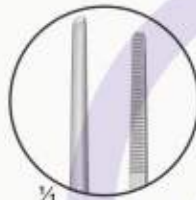

POTTS-SMITH
Dressing Forceps
MJ-068 17.5 cm, 7"
MJ-069 21.0 cm, 8 1/4"
MJ-070 25.0 cm, 10"
curved serrated



POTTS-SMITH Tissue Forceps 1x2 teeth
MJ-071 17.5 cm, 7"
MJ-072 21.0 cm, 8 1/4"
MJ-073 25.0 cm, 10"
straight



POTTS-SMITH Tissue Forceps 1x2 teeth
MJ-074 17.5 cm, 7"
MJ-075 21.0 cm, 8 1/4"
MJ-076 25.0 cm, 10"
curved



Pincas a tissu, Anatomische pinzetten
Gewebe, Pinzas de disección

Pinzas para tejidos, Pincas à dissection
Pinze per tessuti, Pinze per dissezione

Brophy Dressing Forceps
MJ-077 20.0 cm, 8"
straight serrated

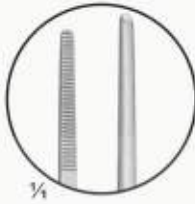

Brophy Dressing Forceps
MJ-078 20.0 cm, 8"
curved serrated



Brophy Tissue Forceps
1x2 teeth
MJ-079 20.0 cm, 8"
straight serrated

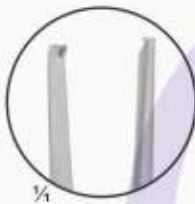

Brophy Tissue Forceps
1x2 teeth
MJ-080 20.0 cm, 8"
curved serrated



Semken Tissue Forceps
MJ-081 12.7 cm, 5"
MJ-082 15.2 cm, 6"
1x2 teeth, straight



Semken Tissue Forceps
MJ-083 12.7 cm, 5"
MJ-084 15.2 cm, 6"
1x2 teeth, curved



Pincas a tissu, Anatomische pinzetten | *Pinzas para tejidos, Pincas à dissection*
Gewebe, Pinzas de disección | *Pinze per tessuti, Pinze per dissezione*

Taylor Dressing Forceps
MJ-085 17.5 cm 7"
 straight serrated



Taylor Dressing Forceps
MJ-086 17.5 cm 7"
 curved serrated

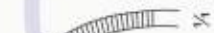

Taylor Tissue Forceps
MJ-087 17.5 cm, 7"
 1x2 teeth, Straight



Taylor Tissue Forceps
MJ-088 17.5 cm, 7"
 1x2 teeth, Curved



Taylor Bayonet Dressing Forceps
MJ-089 17.5 cm 7"



Taylor Bayonet Tissue Forceps 1x2 teeth
MJ-090 17.5 cm, 7"



Pincas a tissu, Anatomische pinzetten
Gewebe, Pinzas de disección

Pinzas para tejidos, Pincas à dissection
Pinze per tessuti, Pinze per dissezione



Cushing Dressing Forceps
MJ-091 17.8 cm, 7"
Serrated Straight



Cushing Dressing Forceps
MJ-092 17.8 cm, 7"
Serrated Curved

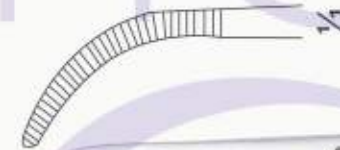

Cushing Tissue Forceps
1x2 teeth
MJ-093 17.8 cm, 7"
Straight



Cushing Tissue Forceps
1x2 teeth
MJ-094 17.8 cm, 7"
Curved



INSTRUMENTS

Pinces a tissu, Anatomische pinzetten
Gewebe, Pinzas de disección

Pinzas para tejidos, Pinces à dissection
Pinze per tessuti, Pinze per dissezione



ADSON Bayonet Dressing Forceps
MJ-095 21 cm 8 1/4"
serrated



CUSHING Dressing Forceps
MJ-096 18.4 cm 7 1/4"
bayonet, serrated,
scraper end



CUSHING Dressing Forceps
MJ-097 18.4 cm 7 1/4"
1 X 2 teeth, bayonet,
scraper end

TISSUE & DRESSING FORCEPS

Pinzas para tejidos, Pincas à dissection | Pincas a tissu, Anatomische pinzetten
Pinze per tessuti, Pinze per dissezione | Gewebe, Pinzas de disección



WANGENSTEEN
Dressing Forceps
MJ-098 23 cm, 9"



Stone Tissue Forceps
4X5 Teeth
MJ-099 15.2 cm, 6"



Lerche Tissue Forceps
5X6 Teeth
MJ-100 15 cm, 6"



Adlerkreutz Tissue
Forceps 2X3 Teeth
MJ-101 15 cm, 6"
MJ-102 20 cm, 8"

INSTRUMENTS

Pinzas para tejidos, Pincas à dissection | Pincas a tissu, Anatomische pinzetten
Pinze per tessuti, Pinze per dissezione | Gewebe, Pinzas de disección



Adlerkreutz Tissue Forceps 4X5 Teeth
MJ-103 15 cm, 6"
MJ-104 20 cm, 8"



Gillies Tissue Forceps 1X2 Teeth
MJ-105 15 cm, 6"
 straight serrated



Gillies Tissue Forceps 1X2 Teeth
MJ-106 15 cm, 6"
 curved serrated



Tissue Forceps 2x3 Teeth
MJ-107 11.4 cm 4 1/2"
MJ-108 13.0 cm 5"
MJ-109 14.5 cm 5 3/4"
MJ-110 16.0 cm 6 1/4"
MJ-111 17.5 cm 7"
MJ-112 20.0 cm 8"
MJ-113 25.0 cm 10"
MJ-114 30.0 cm 12"



Pinzas para tejidos, Pinces à dissection | Pincers a tissu, Anatomische pinzetten
Pinze per tessuti, Pinze per dissezione | Gewebe, Pinzas de disección



Tissue Forceps 3x4 Teeth
 MJ-115 11.4 cm 4 1/2"
 MJ-116 12.7 cm 5"
 MJ-117 14 cm 5 1/2"
 MJ-118 15.9 cm 6 1/4"
 MJ-119 17.8 cm 7"
 MJ-120 20.3 cm 8"
 MJ-121 25.4 cm 10"
 MJ-122 30.5 cm 12"



Tissue Forceps 4x5 Teeth
 MJ-123 11.4 cm 4 1/2"
 MJ-124 12.7 cm 5"
 MJ-125 14 cm 5 1/2"
 MJ-126 15.9 cm 6 1/4"
 MJ-127 17.8 cm 7"
 MJ-128 20.3 cm 8"
 MJ-129 25.4 cm 10"
 MJ-130 30.5 cm 12"



Iris Tissue Forceps
 MJ-131 10.2 cm, 4"
 1x2 Teeth, Straight



Iris Tissue Forceps
 MJ-132 10.2 cm, 4"
 1x2 Teeth, Half Curved

INSTRUMENTS

Pinzas para tejidos, Pincas à dissection | Pincas a tissu, Anatomische pinzetten
Pinze per tessuti, Pinze per dissezione | Gewebe, Pinzas de disección



Iris Tissue Forceps
MJ-133 10.2 cm, 4"
 1x2 Teeth, Full Curved



Waugh Dressing Forceps
MJ-134 15.0 cm, 6"
MJ-135 18.0 cm, 7"
 slightly heavier
 non-toothed,
 serrated jaws.



Waugh Tissue Forceps
1x2 Teeth
MJ-136 15.0 cm, 6"
MJ-137 18.0 cm, 7"
 as above but one two
 tooth on serrated jaws.
 Known as Scott.



Leedham Tissue Forceps
1x2 Teeth
MJ-138 14.5 cm, 5.75"
MJ-139 18.0 cm, 7"
 Green Dissecting
 Forceps two three
 teeth, smooth jaws.

Pinzas para tejidos, Pincas à dissection | Pincas a tissu, Anatomische pinzetten
Pinze per tessuti, Pinze per dissezione | Gewebe, Pinzas de disección



Treves Tissue Forceps
1x2 Teeth
MJ-140 12.5 cm, 5"
MJ-141 15.0 cm, 6"
MJ-142 18.0 cm, 7"
Dissecting Forceps
teeth, on smooth jaws.



Charnley Tissue Forceps
1x2 Teeth
MJ-143 14.5 cm, 5 3/4"
MJ-144 18.0 cm, 7"
Dissecting Forceps
one into two teeth,
block on jaws.



Ramsay Dissecting Forceps
MJ-145 18.0 cm, 7"
serrated jaws.

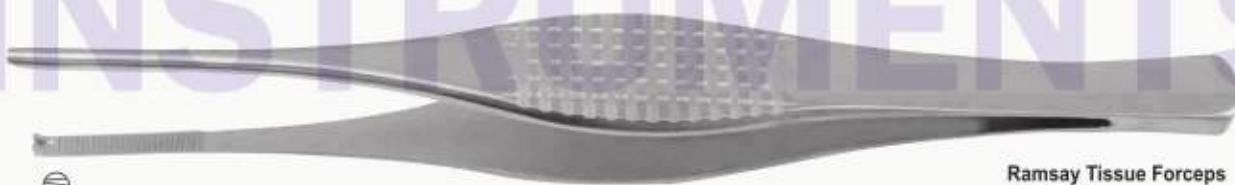

Ramsay Tissue Forceps
1x2 Teeth
MJ-146 18.0 cm, 7"
Dissecting Forceps
one into teeth on
serrated jaws.

INSTRUMENTS

TISSUE & DRESSING FORCEPS

Pinces a tissu, Anatomische pinzetten | *Pinzas para tejidos, Pinces à dissection*
Gewebe, Pinzas de disección | *Pinze per tessuti, Pinze per dissezione*



Feilchenfeld
 MJ-147 07.5 cm, 5"
 MJ-148 09.0 cm, 6"
 MJ-149 11.5 cm, 7"



Ferris-Smith Tissue Forceps 1x2 Teeth
 MJ-150
 18 cm, 7"



Ferris-Smith Tissue Forceps 2x3 Teeth
 MJ-151
 18 cm, 7"

TISSUE & DRESSING FORCEPS

Pincas a tissu, Anatomische pinzetten | *Pinzas para tejidos, Pincas à dissection*
Gewebe, Pinzas de disección | *Pinze per tessuti, Pinze per dissezione*



**Lane Tissue Forceps
1x2 Teeth**
 MJ-152 12.5cm, 5 1/2"
 MJ-153 15 cm, 6"
 MJ-154 17 cm, 6 3/4"
 MJ-155 18 cm, 7"
 MJ-156 20 cm, 8"



**Lane Tissue Forceps
2x3 Teeth**
 MJ-157 12.5cm, 5 1/2"
 MJ-158 15 cm, 6"
 MJ-159 17 cm, 6 3/4"
 MJ-160 18 cm, 7"
 MJ-161 20 cm, 8"



**Bonney Tissue Forceps
1x2 Teeth**
 MJ-162
 18 cm, 7"



**Bonney Tissue Forceps
2x3 Teeth**
 MJ-163
 18 cm, 7"



TISSUE & DRESSING FORCEPS

Pinzas para tejidos, Pincas à dissection | *Pincas a tissu, Anatomische pinzetten*
Pinze per tessuti, Pinze per dissezione | *Gewebe, Pinzas de disección*



Durante Tissue Grasping Forceps
 MJ-164 14.5cm, 5 3/4"
 MJ-165 16 cm, 6 1/4"
 MJ-166 20 cm, 8"



Nelson Tissue Forceps
 MJ-167 23 cm, 9"
 6x7 Teeth



Russian-Modell Tissue Forceps
 MJ-168 15 cm, 6"
 MJ-169 20 cm, 8"
 MJ-170 25 cm, 10"



Singley-Tuttle Forceps
 MJ-171
 23 cm, 9"



INSTRUMENTS

Pinzas para tejidos, Pincas à dissection | Pincas a tissu, Anatomische pinzetten
Pinze per tessuti, Pinze per dissezione | Gewebe, Pinzas de disección



Grasping Forceps

Collin-Duval Forceps



14mm



MJ-172
20 cm, 8"

18mm



MJ-173
20 cm, 8"

27mm



MJ-174
20 cm, 8"



Stille-Barraya Tissue
Forceps 3x4 Teeth
MJ-175 18 cm, 7"
MJ-176 20 cm, 8"
MJ-177 25 cm, 10"



Duehrssen Dressing
Forceps
MJ-178 20 cm, 8"
Serrated



Duehrssen Tissue
Forceps 1x2 Teeth
MJ-179
20 cm, 8"

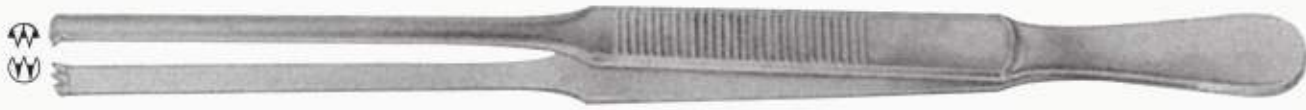

Duehrssen Tissue
Forceps 2x3 Teeth
MJ-180
20 cm, 8"

INSTRUMENTS

TISSUE & DRESSING FORCEPS

Pinces a tissu, Anatomische pinzetten | *Pinzas para tejidos, Pince à dissection*
Gewebe, Pinzas de disección | *Pinze per tessuti, Pinze per dissezione*



Duehrssen Tissue Forceps
3x4 Teeth
MJ-181
 20 cm, 8"



Narrow Tip

Duehrssen Dressing Forceps
MJ-182
 20 cm, 8"

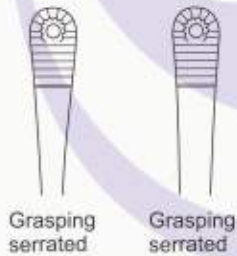

Mayo-Russian Forceps
MJ-183 15.5cm, 6"
MJ-184 23.0cm, 9"



Davis Forceps
MJ-185
 25 cm, 10"

Pinzas para tejidos, Pinces à dissection | Pinces a tissu, Anatomische pinzetten
Pinze per tessuti, Pinze per dissezione | Gewebe, Pinzas de disección



Yasargil-Sami Forceps
Jaws Spoon-Shaped
24 cm, 9 1/4"

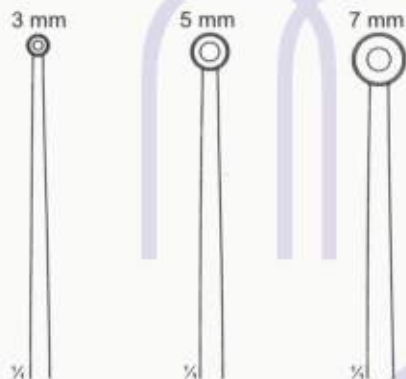

MJ-186
24 cm, 9 1/4"
3mm hole

MJ-187
24 cm, 9 1/4"
5mm hole

MJ-188
24 cm, 9 1/4"
7mm hole



Yasargil Forceps
Jaws Spoon-Shaped
22 cm, 8 3/4"

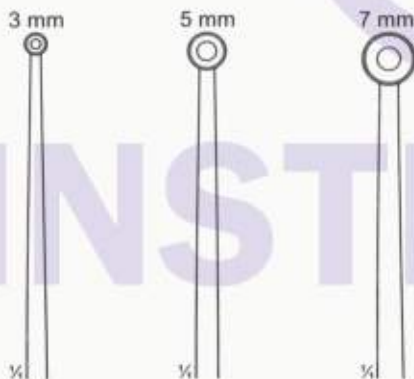

MJ-189
22 cm, 8 3/4"
3mm hole

MJ-190
22 cm, 8 3/4"
5mm hole

MJ-191
22 cm, 8 3/4"
7mm hole

INSTRUMENTS

Pinzas para tejidos, Pincas à dissection | Pincas a tissu, Anatomische pinzetten
Pinze per tessuti, Pinze per dissezione | Gewebe, Pinzas de disección

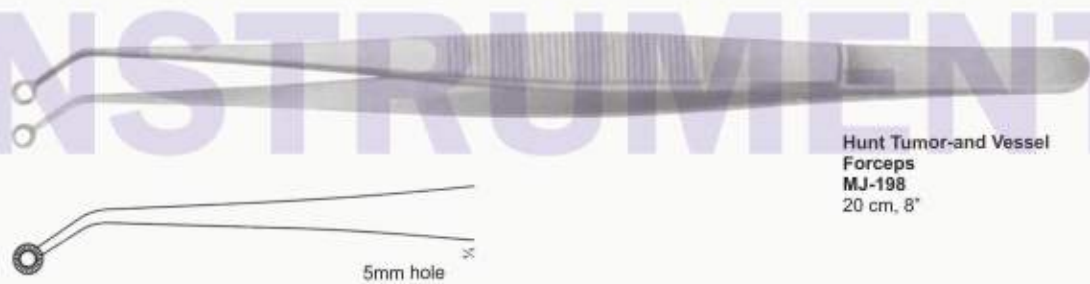
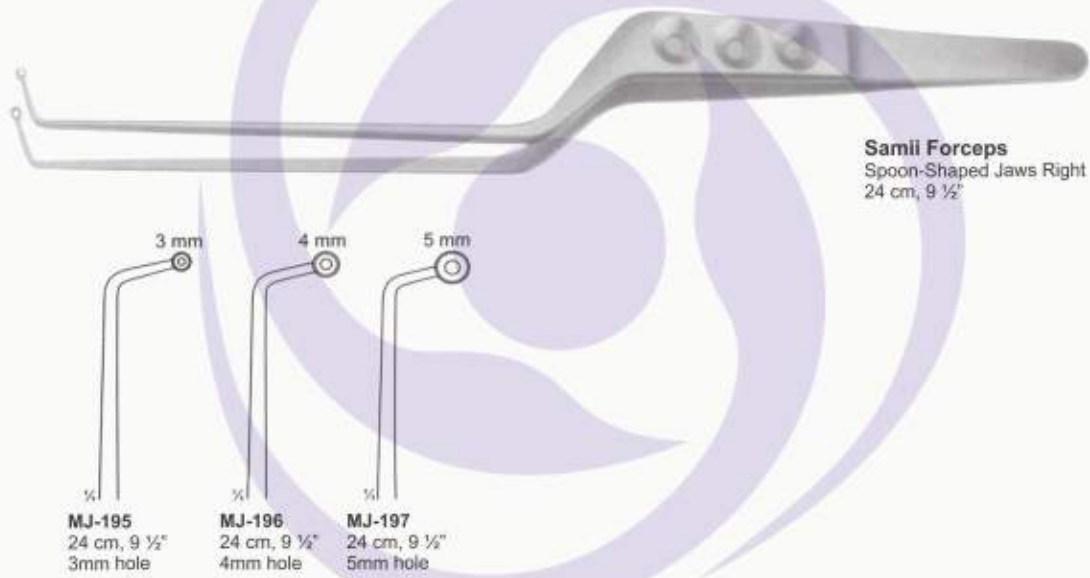
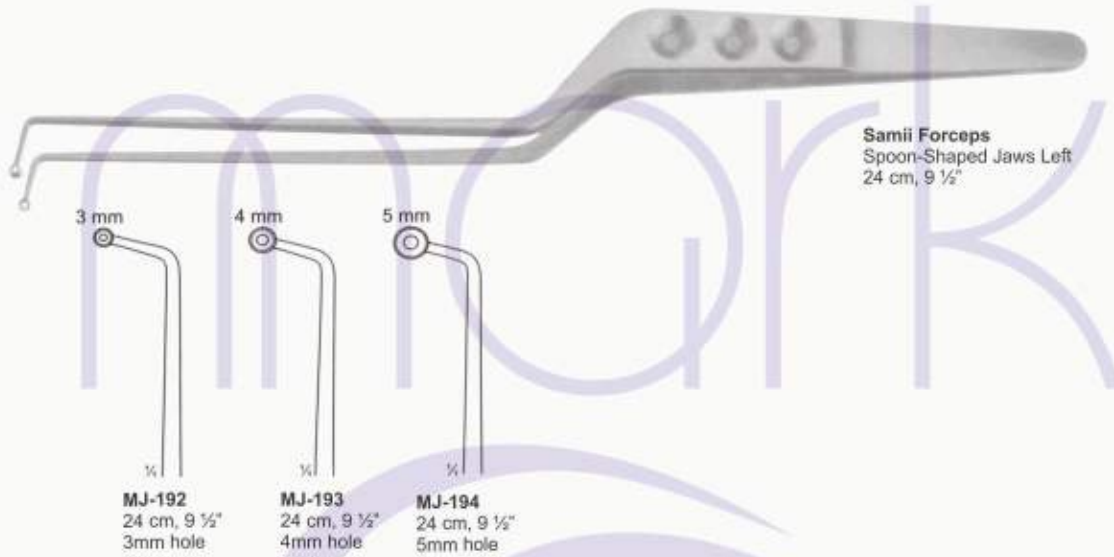

Pinzas para tejidos, Pincas à dissection
Pinze per tessuti, Pinze per dissezione

Pinces a tissu, Anatomische pinzetten
Gewebe, Pinzas de disección



LUCAE / ENT Dressing Forceps
MJ-199
14 cm, 5 1/2"
Dressing, Serrated
MJ-200
16 cm, 6 1/4"
Dressing, Serrated
MJ-201
20 cm, 8"
Dressing, Serrated



Paper Dressing Forceps
MJ-202 15 cm, 6"



Paper Dressing Forceps
MJ-203 15 cm, 6"



Paper Dressing Forceps
MJ-204 15 cm, 6"
Straight



Paper Dressing Forceps
MJ-205 15 cm, 6"
Curved

TISSUE & DRESSING FORCEPS

Pincas a tissu, Anatomische pinzetten | Pinzas para tejidos, Pincas à dissection
Gewebe, Pinzas de disección | Pinze per tessuti, Pinze per dissezione



Adson Tissue Forceps
Cuter Print



MJ-206 regular point straight
MJ-207 fine point straight
MJ-208 mirco point straight
12 cm, 4 3/4" 1x2 Teeth



MJ-209 regular point with platform straight
MJ-210 fine point with platform straight
MJ-211 mirco point with platform straight
12 cm, 4 3/4" 1x2 Teeth



MJ-212 regular point curved
MJ-213 fine point curved
MJ-214 mirco point curved
12 cm, 4 3/4" 1x2 Teeth



MJ-215 regular point straight
MJ-216 fine point straight
MJ-217 mirco point straight
12 cm, 4 3/4" 1x2 Teeth



Adson Brown Tissue



MJ-218 regular point, straight
MJ-219 fine point, straight
Forceps, 12cm 4 3/4"
9x9 teeth



MJ-220 regular point, Curved
MJ-221 fine point, Curved
Forceps, 12cm 4 3/4"
9x9 teeth

TISSUE & DRESSING FORCEPS

*Pincas a tissu, Anatomische pinzetten
Gewebe, Pinzas de disección*

*Pinzas para tejidos, Pincas à dissection
Pinze per tessuti, Pinze per dissezione*



Adson Tissue Forceps
with fenestrated handle



MJ-222 regular point straight
MJ-223 fine point straight
MJ-224 mirco point straight
12 cm, 4 3/4" 1x2 Teeth



MJ-225 regular point with platform straight
MJ-226 fine point with platform straight
MJ-227 mirco point with platform straight
12 cm, 4 3/4" 1x2 Teeth



MJ-228 regular point curved
MJ-229 fine point curved
MJ-230 mirco point curved
12 cm, 4 3/4" 1x2 Teeth



MJ-231 regular point curved
MJ-232 fine point curved
MJ-233 mirco point curved
12 cm, 4 3/4" 1x2 Teeth



Adson Brown Tissue Forceps
Fenestrated Handle



MJ-234 regular point, straight
MJ-235 fine point, straight
12cm 4 3/4"
7x7 teeth



MJ-236 regular point, Curved
MJ-237 fine point, Curved
12cm 4 3/4"
7x7 teeth

INSTRUMENTS

Pinces a tissu, Anatomische pinzetten | *Pinzas para tejidos, Pincas à dissection*
Gewebe, Pinzas de disección | *Pinze per tessuti, Pinze per dissezione*



Graefe Forceps



MJ-238
7.0 cm, 2 3/4"
MJ-239
10.0 cm, 4"
straight
serrated



MJ-240
7.0 cm, 2 3/4"
MJ-241
10.0 cm, 4"
half curved
serrated

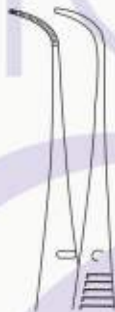

MJ-242
7.0 cm, 2 3/4"
MJ-243
10.0 cm, 4"
full curved
serrated



MJ-244 1x2 teeth
7.0 cm, 2 3/4"
MJ-245 1x2 teeth
10.0 cm, 4"
straight



MJ-246 1x2 teeth
7.0 cm, 2 3/4"
MJ-247 1x2 teeth
10.0 cm, 4"
half curved



MJ-248 1x2 teeth
7.0 cm, 2 3/4"
MJ-249 1x2 teeth
10.0 cm, 4"
full curved

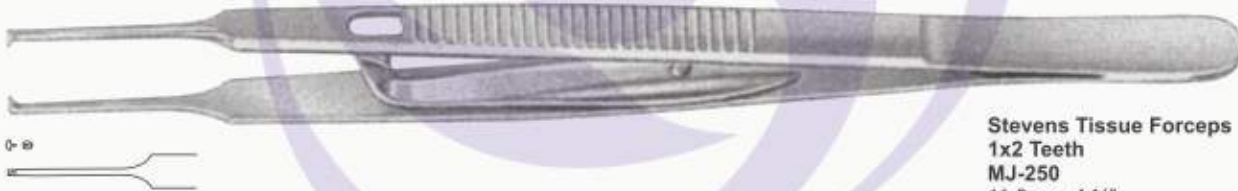

Stevens Tissue Forceps
1x2 Teeth
MJ-250
11.0 cm, 4 1/2"
straight

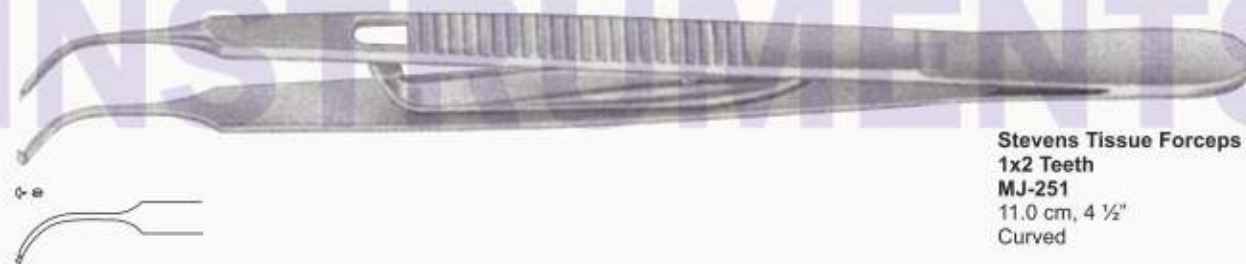

Stevens Tissue Forceps
1x2 Teeth
MJ-251
11.0 cm, 4 1/2"
Curved

Pinces a tissu, Anatomische pinzetten | *Pinzas para tejidos, Pinces à dissection*
Gewebe, Pinzas de disección | *Pinze per tessuti, Pinze per dissezione*



Graefe Dressing Forceps
MJ-252 0.5 mm
MJ-253 0.7 mm
MJ-254 1.0 mm
7.0 cm, 3"
straight serrated



Graefe Dressing Forceps
MJ-255 0.5 mm
MJ-256 0.7 mm
MJ-257 1.0 mm
7.0 cm, 3"
curved serrated



Graefe Tissue Forceps
1x2 Teeth
MJ-258 0.5 mm
MJ-259 0.7 mm
MJ-260 1.0 mm
7.0 cm, 3"
straight



Graefe Tissue Forceps
1x2 Teeth
MJ-261 0.5 mm
MJ-262 0.7 mm
MJ-263 1.0 mm
7.0 cm, 3"
curved



Graefe Fixation Forceps
MJ-264
11.2 cm 4 3/8"
standard jaws 4.5mm wide
with fine teeth

INSTRUMENTS

Chirurgische pinzetten, Uhrmacher-Pinzetten

Pinzas de disección con dientes, Pinzas de relojero

Pinces à dissection à groffes, Pinces d'horloger

Pinze per dissezione con denti, Pinze de orologiaio



**Dumont Forceps
MJ-265** 11.5 cm, 4 1/2"
curved



MJ-266
10.5 cm, 4"
full curved



MJ-267
10.5 cm, 4"
half curved



MJ-268
11 cm, 4 1/2"



MJ-269
11 cm, 4 1/2"
fine point



MJ-270
11 cm, 4 1/2"
extra fine point



MJ-271
12 cm, 5"
fine point



MJ-272
12 cm, 5"
extra fine point



MJ-273
12 cm, 5"



**Dumont Forceps
MJ-274**
style 1, fine point,
12.1 cm 4 3/4"



**Dumont Forceps
MJ-275**
style 2, strong
fine point,
12.1 cm 4 3/4"

Chirurgische pinzetten, Uhrmacher-Pinzetten
Pinzas de disección con dientes, Pinzas de relojero

Pinces à dissection à groffes, Pinces d'horloger
Pinze per dissezione con denti, Pinze de orologiaio



**Dumont Forceps
MJ-276**
style 3, narrow
fine point,
12.1 cm 4 3/4"



**Dumont Forceps
MJ-277**
style 3C, narrow
fine point,
11.2 cm 4 3/8"



**Dumont Forceps
MJ-278**
style 4, fine point,
11.2cm 4 3/8"



**Dumont Forceps
MJ-279**
style 5, super fine
11.2cm point, 4 3/8"

Chirurgische pinzetten, Uhrmacher-Pinzetten

Pinzas de disección con dientes, Pinzas de relojero

Pinces à dissection à groffes, Pinces d'horloger

Pinze per dissezione con denti, Pinze de orologiaio



**Dumont Forceps
MJ-280**
style 5, micro fine
11.2cm point, 4 3/8"



**Dumont Forceps
MJ-281**
style 6, pick up,
11.4 cm 4 1/2"



**Dumont Forceps
MJ-282**
style 7, fine curved,
11.4 cm 4 1/2"



**Dumont Forceps
MJ-283**
style 7, micro fine
11.4 cm curved, 4 1/2"

Chirurgische pinzetten, Uhrmacher-Pinzetten
Pinzas de disección con dientes, Pinzas de relojero

Pinces à dissection à groffes, Pinces d'horloger
Pinze per dissezione con denti, Pinze de orologiaio



Jeweler Type
Tweezers
MJ-284
style 3, micro fine



Jeweler Type
Tweezers
MJ-285
style 5A, micro fine



Jeweler Type
Tweezers
MJ-286
style AA, micro fine



Jeweler Type
Tweezers
MJ-287
style MM, micro fine

INSTRUMENTS

Chirurgische pinzetten, Uhrmacher-Pinzetten

Pinzas de disección con dientes, Pinzas de relojero

Pinces à dissection à groffes, Pinces d'horloger

Pinze per dissezione con denti, Pinze de orologiaio



**Jeweler Type
Tweezers
MJ-288**
style MM, micro fine
Blue Coated



**Jeweler Type
Tweezers
MJ-289**
style 00, micro fine



**Jeweler Type
Tweezers
MJ-290**
style SS, micro fine



**Jeweler Type
Tweezers
MJ-291**
style SSSA, micro fine

Chirurgische pinzetten, Uhrmacher-Pinzetten
Pinzas de disección con dientes, Pinzas de relojero

Pinces à dissection à groffes, Pincés d'horloger
Pinze per dissezione con denti, Pinze de orologiaio



Jeweler Type
Tweezers
MJ-292



Jeweler Type
Tweezers
MJ-293
micro fine



Jeweler Type
Tweezers
MJ-294
micro fine



Jeweler Type
Tweezers
MJ-295
micro fine



JEWELER TYPE, DISSECTING FORCEPS

Chirurgische pinzetten, Uhrmacher-Pinzetten

Pinzas de disección con dientes, Pinzas de relojero

Pinces à dissection à groffes, Pinces d'horloger

Pinze per dissezione con denti, Pinze de orologiaio



Jeweler Type
Tweezers
MJ-296
Grooved



Jeweler Type
Tweezers
MJ-297



Jeweler Type
Tweezers
MJ-298



Jeweler Type
Tweezers
MJ-299

Chirurgische pinzetten, Uhrmacher-Pinzetten
Pinzas de disección con dientes, Pinzas de relojero

Pinces à dissection à groffes, Pincés d'horloger
Pinze per dissezione con denti, Pinze de orologio



Jeweler Type
Tweezers
MJ-300



Jeweler Type
Tweezers
MJ-301



Jeweler Type
Tweezers
MJ-302



Jeweler Type
Tweezers
MJ-303

INSTRUMENTS

Chirurgische pinzetten, Uhrmacher-Pinzetten

Pinzas de disección con dientes, Pinzas de relojero

Pinces à dissection à groffes, Pinces d'horloger

Pinze per dissezione con denti, Pinze de orologiaio



Jeweler Type
Tweezers
MJ-304



Jeweler Type
Tweezers
MJ-305



Jeweler Type
Tweezers
MJ-306



Jeweler Type
Tweezers
MJ-307

INSTRUMENTS

Chirurgische pinzetten, Uhrmacher-Pinzetten
Pinzas de disección con dientes, Pinzas de relojero

Pinces à dissection à groffes, Pincés d'horloger
Pinze per dissezione con denti, Pinze de orologiaio



Jeweler Type
Tweezers
MJ-308



Jeweler Type
Tweezers
MJ-309



Jeweler Type
Tweezers
MJ-310



Jeweler Type
Tweezers
MJ-311

INSTRUMENTS

Chirurgische pinzetten, Uhrmacher-Pinzetten

Pinces à dissection à groffes, Pincers d'horloger

Pinzas de disección con dientes, Pinzas de relojero

Pinze per dissezione con denti, Pinze de orologiaio



Jeweler Type
Tweezers
MJ-312



Jeweler Type
Tweezers
MJ-313



Jeweler Type
Tweezers
MJ-314

Chirurgische pinzetten, Uhrmacher-Pinzetten

Pinces à dissection à groffes, Pincés d'horloger

Pinzas de disección con dientes, Pinzas de relojero

Pinze per dissezione con denti, Pinze de orologiaio



Jeweler Type
Tweezers
MJ-315
Grooved



Jeweler Type
Tweezers
MJ-316
Grooved



Jeweler Type
Tweezers
MJ-317
Grooved



Jeweler Type
Tweezers
MJ-318
Grooved



INSTRUMENTS

Chirurgische pinzetten, Uhrmacher-Pinzetten

Pinzas de disección con dientes, Pinzas de relojero

Pinces à dissection à groffes, Pincés d'horloger

Pinze per dissezione con denti, Pinze de orologiaio



Jeweler Type
Tweezers
MJ-319



Jeweler Type
Tweezers
MJ-320



Jeweler Type
Tweezers
MJ-321



Jeweler Type
Tweezers
MJ-322

INSTRUMENTS

DRESSING FORCEPS

Anatomische pinzetten | Pincés à dissection
Pinzas de disección | Pinze Anatomiche per dissezion



Dressing Forceps
MJ-323 160mm
18



Dressing Forceps
MJ-324 160mm
NC # 18



Dressing Forceps
MJ-325 160mm
NC # 18
with Serration



Dressing Forceps
MJ-326 145mm
Mini # 18



Dressing Forceps
MJ-327 145mm
Mini # 18
with Serration

Anatomische pinzetten
Pinzas de disección

Pinces à dissection
Pinze Anatomiche per dissezion



Dressing Forceps
MJ-328 160mm
NC # 18
with Diamond



Dressing Forceps
MJ-329 160mm
Delicate Tweezers



Dressing Forceps
MJ-330 165mm



Dressing Forceps
MJ-331 165mm
Light Weight

INSTRUMENTS



Dressing Forceps
MJ-332 155mm
Titanium with serration

Anatomische pinzetten
Pinzas de disección

Pinces à dissection
Pinze Anatomiche per dissezion

Endodontic Tweezers



INSTRUMENTS

Pinzas para tejidos, Pincas à dissection | Pincas a tissu, Anatomische pinzetten
Pinze per tessuti, Pinze per dissezione | Gewebe, Pinzas de disección

Tissue Pliers
-with Hook-



MJ-338
 Straight



MJ-339
 Curved



MJ-340

-without Hook-



MJ-341
 Straight



MJ-342
 Curved

INSTRUMENTS

Pinzas para tejidos, Pincas à dissection | Pincas a tissu, Anatomische pinzetten
Pinze per tessuti, Pinze per dissezione | Gewebe, Pinzas de disección

Tissue Pliers
-with Curette-

With curette shaped tip, able to hold and remove the granulation tissue.



-Lucae-



-Suture Pliers-



Pinzas para tejidos, Pincas à dissection | Pincas a tissu, Anatomische pinzetten
Pinze per tessuti, Pinze per dissezione | Gewebe, Pinzas de disección

Tissue Pliers
-McIndoe-



-Adson-

*Soft tissue is delicately hold at the time of a suture and an operation.

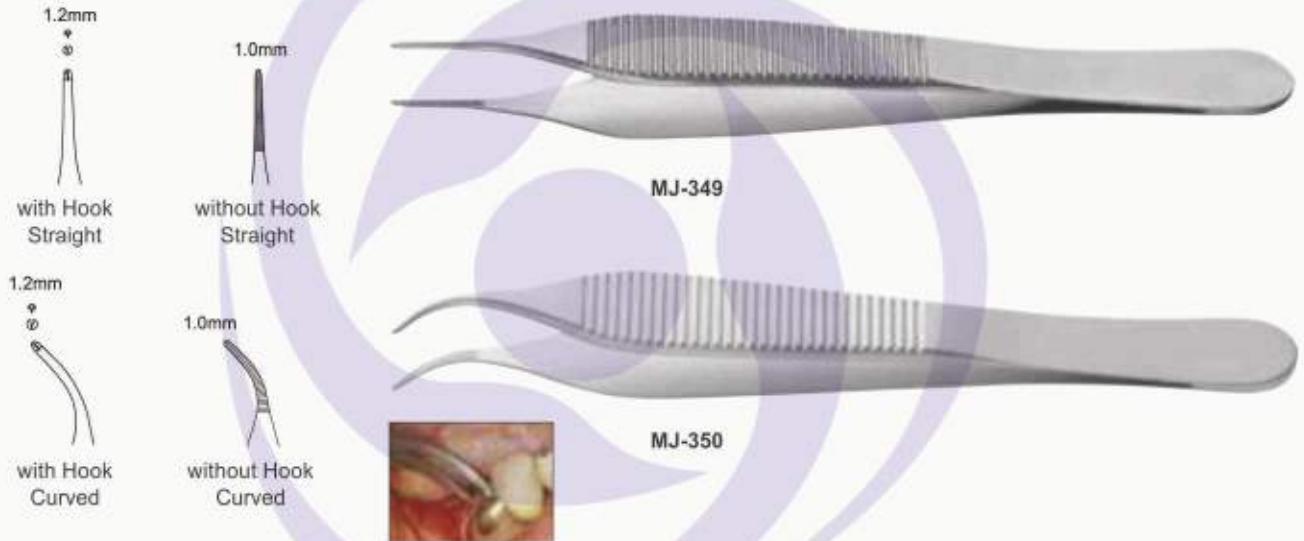

-Graefe-

*Alternate serrated tips will not damage the gum during suturing.

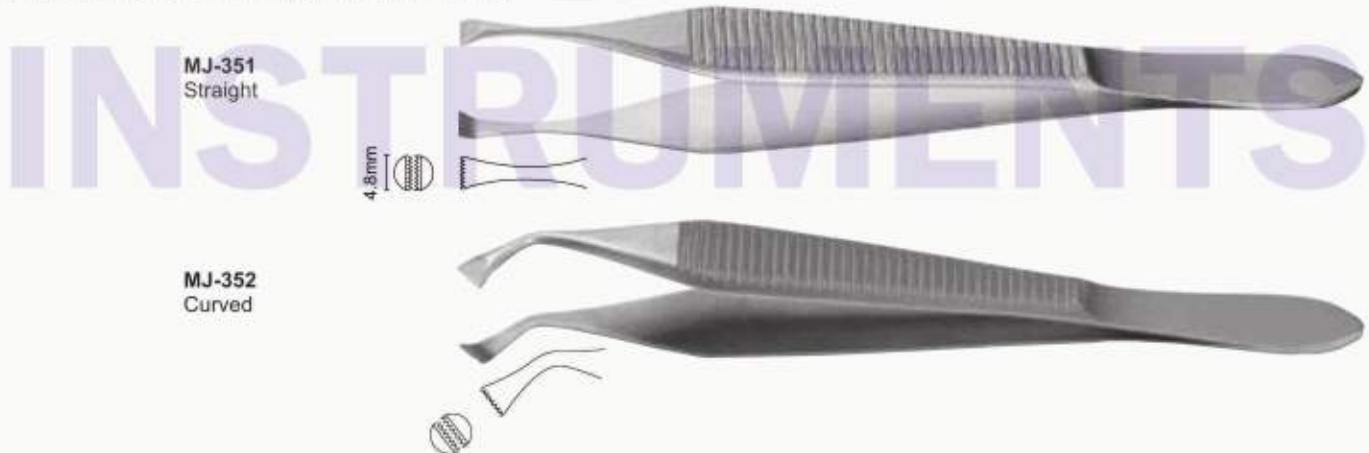

Pinzas para tejidos, Pincas à dissection | Pincas a tissu, Anatomische pinzetten
Pinze per tessuti, Pinze per dissezione | Gewebe, Pinzas de disección



Dressing Forceps
MJ-353 155mm
 Titanium with serration

Micro Tissue Pliers

*Rounded handle provides fine control of the tip.

-MS-150 S-



MJ-354 150mm
 Straight



MJ-355 150mm
 Curved

-MS-150 L-



MJ-356 150mm
 Straight



MJ-357 150mm
 Curved

-MS-150 with Ring-

*with wide circular tip can hold gingiva firmly.

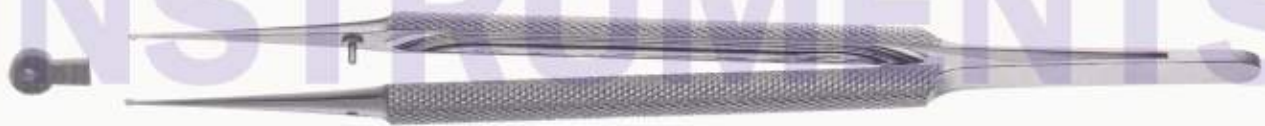

MJ-358 150mm
 Straight



MJ-359 150mm
 Curved

Pinzas para tejidos, Pincas à dissection | Pincas a tissu, Anatomische pinzetten
Pinze per tessuti, Pinze per dissezione | Gewebe, Pinzas de disección

Tissue Pliers -Micro Adson S-

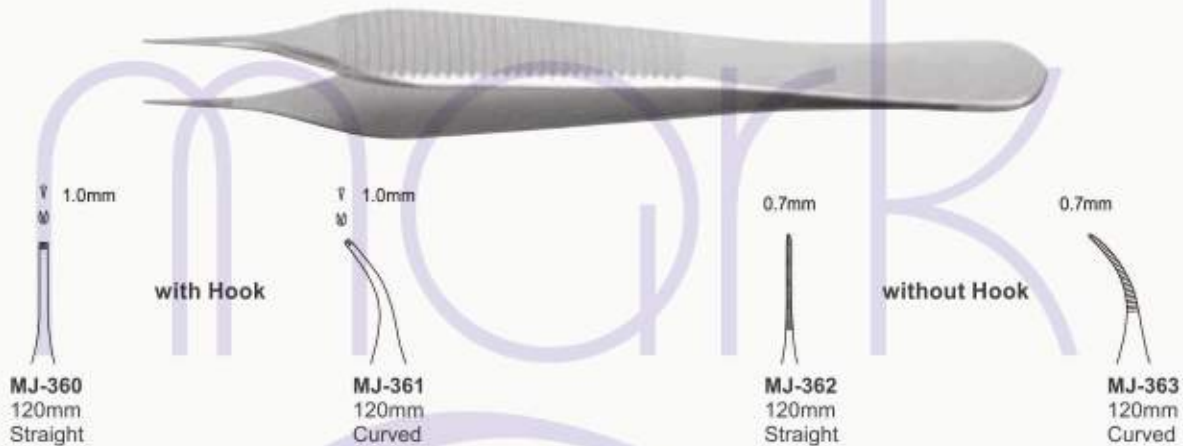

-Micro Adson L-

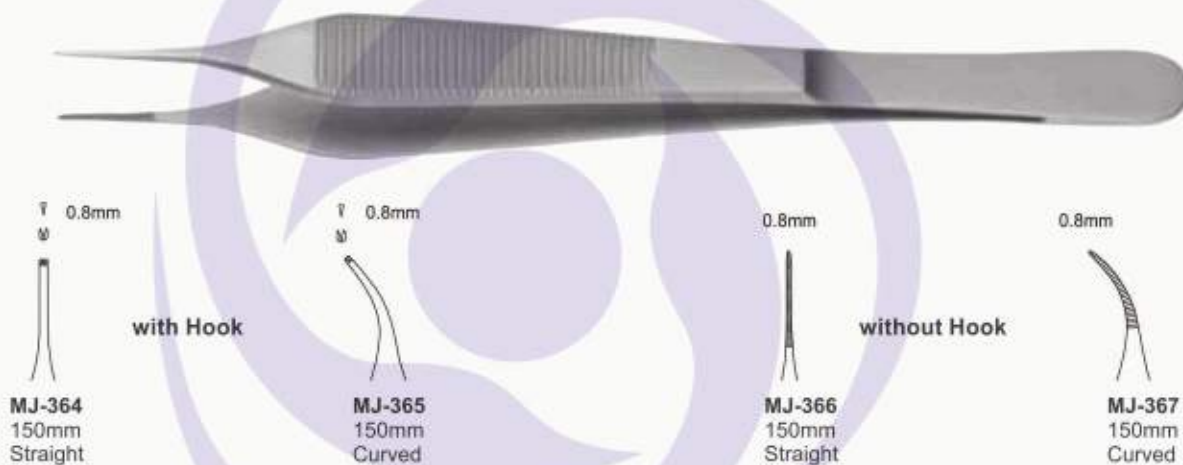

MTA Tweezers



Pinzas para tejidos, Pincas à dissection | Pincas a tissu, Anatomische pinzetten
Pinze per tessuti, Pinze per dissezione | Gewebe, Pinzas de disección

Articulating Paper Holder



-Inter Teeth-

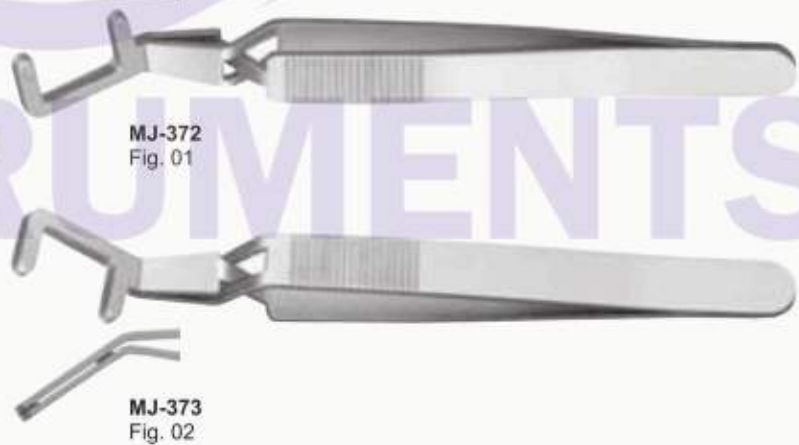

Pinzas para tejidos, Pincas à dissection | Pincas a tissu, Anatomische pinzetten
Pinze per tessuti, Pinze per dissezione | Gewebe, Pinzas de disección

Jacquette Holder

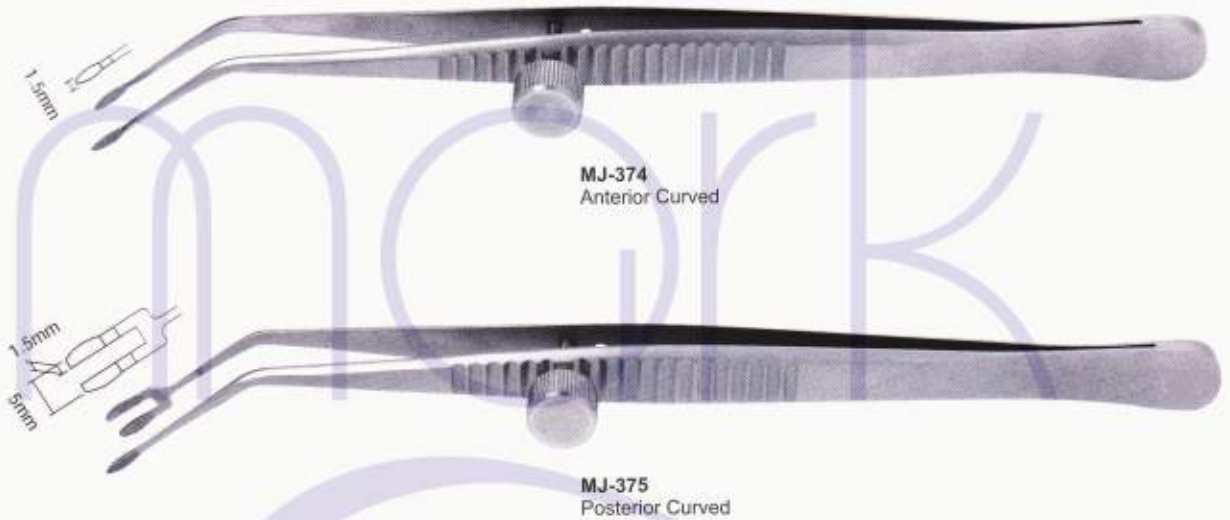

P.K. Thomas Tweezers rop-on Technique



Locking Tweezers



INSTRUMENTS

Pinzas para tejidos, Pincas à dissection | Pincas a tissu, Anatomische pinzetten
Pinze per tessuti, Pinze per dissezione | Gewebe, Pinzas de disección

Laboratory Tweezers



MJ-379
Straight



MJ-380
Curved



MJ-381
For Acid
vinyl Coated

-Slim-



MJ-382
Straight



MJ-383
Curved

General Tweezers



MJ-384 23cm
Curved

Pinces a tissu, Anatomische pinzetten
Gewebe, Pinzas de disección

Pinzas para tejidos, Pinces à dissection
Pinze per tessuti, Pinze per dissezione



MJ-385
Fig.1
Adson
12cm



MJ-386
Fig.1
Adson 1x2
12cm



MJ-387
Fig.1
Semken-Taylor
12.5cm



MJ-388
Fig.2
Semken-Taylor
12.5cm



MJ-389
Fig.1
Semken-Taylor 1x2
12.5cm

INSTRUMENTS

Pinces a tissu, Anatomische pinzetten
Gewebe, Pinzas de disección

Pinzas para tejidos, Pinces à dissection
Pinze per tessuti, Pinze per dissezione

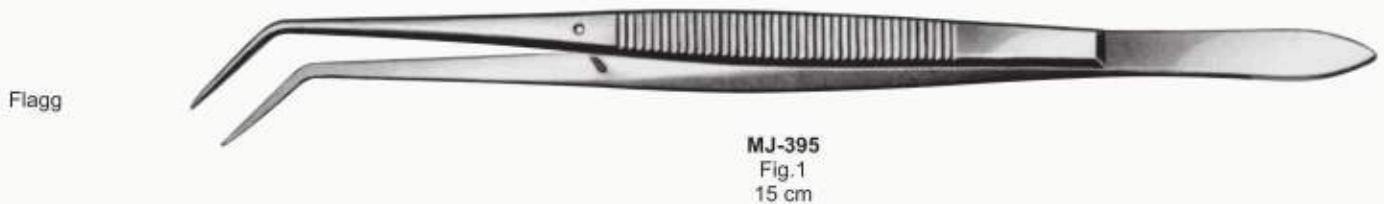
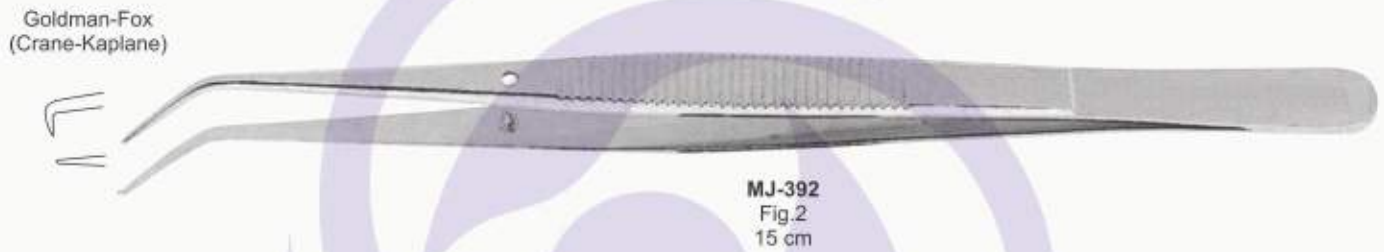
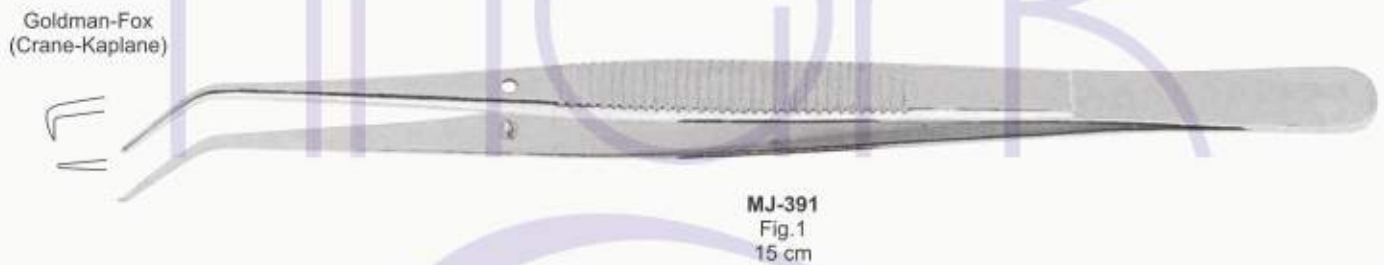

Pinces a tissu, Anatomische pinzetten
Gewebe, Pinzas de disección

Pinzas para tejidos, Pinces à dissection
Pinze per tessuti, Pinze per dissezione



MJ-396
Fig.2
15 cm



MJ-397
Fig.3
16 cm



MJ-398
Fig.4
13 cm



MJ-399
Fig.18L
16 cm



MJ-400
Fig.2
16 cm



MJ-401
Fig.3
16 cm

INSTRUMENTS

Cilienpinzetten | Pincès à épiler les cils
Pinzas depilatorias | Pinze depilatoria



Ziegler Cilia Forceps
MJ-402
9 cm, 3 1/2"



Douglas Cilia Forceps
MJ-403
9 cm, 3 1/2"



Beer Cilia Forceps
MJ-404
9 cm, 3 1/2"



Gradle Cilia Forceps
MJ-405
10.5cm, 4"



<i>Cilienpinzetten</i>	<i>Pinces à épiler les cils</i>
<i>Pinzas depilatorias</i>	<i>Pinze depilatoria</i>



**Kuehne Cilia Forceps
MJ-406**
10.5cm, 4"



**Kuehne Cilia Forceps
MJ-407**
10.5cm, 4"
angled sideways



**Barraquer Cilia Forceps
MJ-408**
10.5cm, 4"



**Littauer Cilia Forceps
MJ-409**
8.5 cm, 3"



**Littauer Cilia Forceps
MJ-410**
9 cm, 3 1/2"

INSTRUMENTS

SPLINTER FORCEPS

Splitterpinzetten | *Pinces à échardes*
Pinzas Para espinas | *Pinze per scheggie*



Splinter Forceps
MJ-411 8 cm, 3"
MJ-412 9 cm, 3 1/2"
MJ-413 10.5 cm, 4"
MJ-414 11.5 cm, 4 1/2"
MJ-415 12.5 cm, 5"
MJ-416 14.5 cm, 5 1/2"
Straight Plain



Splinter Forceps
MJ-417 8 cm, 3"
MJ-418 9 cm, 3 1/2"
MJ-419 10.5 cm, 4"
MJ-420 11.5 cm, 4 1/2"
MJ-421 12.5 cm, 5"
MJ-422 14.5 cm, 5 1/2"
Curved Plain



Splinter Forceps
MJ-423 8 cm, 3"
MJ-424 9 cm, 3 1/2"
MJ-425 10.5 cm, 4"
MJ-426 11.5 cm, 4 1/2"
MJ-427 12.5 cm, 5"
MJ-428 14.5 cm, 5 1/2"
Straight serrated

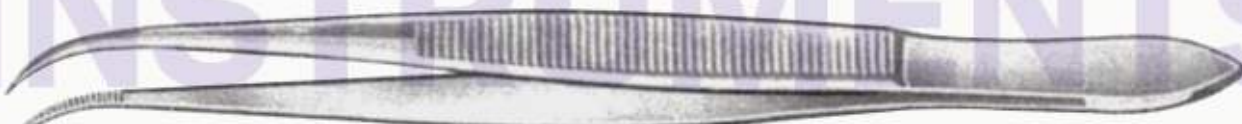

Splinter Forceps
MJ-429 8 cm, 3"
MJ-430 9 cm, 3 1/2"
MJ-431 10.5 cm, 4"
MJ-432 11.5 cm, 4 1/2"
MJ-433 12.5 cm, 5"
MJ-434 14.5 cm, 5 1/2"
Curved serrated

INSTRUMENTS

SPLINTER FORCEPS

Splitterpinzetten | *Pinces à échardes*
Pinzas Para espinas | *Pinze per scheggie*



Hunter Forceps



MJ-435
7.5 cm, 3"
MJ-436
9 cm, 3 1/2"
MJ-437
11 cm, 4"
Straight



MJ-438
10.5 cm, 4"
Straight



Hunter Forceps



MJ-439
10.5 cm, 4"
Curved



Carmalt Forceps



MJ-440
10.5 cm, 4"
Straight

1/4



Carmalt Forceps



MJ-441
10.5 cm, 4"
Curved

1/4

Splitterpinzetten | Pinces à échardes
Pinzas Para espinas | Pinze per scheggie

Splinter Forceps

- MJ-442 8.0 cm, 3"
 - MJ-443 9.0 cm, 3 1/2"
 - MJ-444 10.5 cm, 4"
 - MJ-445 11.5 cm, 4 1/2"
 - MJ-446 12.5 cm 5"
 - MJ-447 14.5 cm 5 1/2"
- Straight serrated with guide pin



Splinter Forceps

- MJ-448 8.0 cm, 3"
 - MJ-449 9.0 cm, 3 1/2"
 - MJ-450 10.5 cm, 4"
 - MJ-451 11.5 cm, 4 1/2"
 - MJ-452 12.5 cm 5"
 - MJ-453 14.5 cm 5 1/2"
- Curved serrated with guide pin



Splinter Forceps

- MJ-454 8.0 cm, 3"
 - MJ-455 9.0 cm, 3 1/2"
 - MJ-456 10.5 cm, 4"
 - MJ-457 11.5 cm, 4 1/2"
 - MJ-458 12.5 cm 5"
 - MJ-459 14.5 cm 5 1/2"
- Straight plain with guide pin



Splinter Forceps

- MJ-460 8.0 cm, 3"
 - MJ-461 9.0 cm, 3 1/2"
 - MJ-462 10.5 cm, 4"
 - MJ-463 11.5 cm, 4 1/2"
 - MJ-464 12.5 cm 5"
 - MJ-465 14.5 cm 5 1/2"
- Curved plain with guide pin



Stieglitz Forceps with Magnifying Mirrors

- MJ-466
- 12.5 cm, 5"



Ochsner Forceps

- MJ-467
- 14 cm, 5 1/2"



Allgemeines Instrumentarium
Instrumental general

Instrumentation générale
Strumentario generale

Lange Tissue
Forceps
MJ-468
10 cm, 4"



Childe Tissue
Forceps
MJ-469
18 cm, 7"



Michel Tissue
Forceps
MJ-470
12 cm, 4 1/2"



Wachenfeldt Tissue
Forceps
MJ-471
12.5 cm, 5"



HEGENBARTH
Tissue Forceps
MJ-472
12.5 cm, 5"



Wachenfeldt
Tissue Forceps
MJ-473
12.5 cm, 5"



INSTRUMENTS

Pincas a tissu, Anatomische pinzetten
Gewebe, Pinzas de disección

Pinzas para tejidos, Pincas à dissection
Pinze per tessuti, Pinze per dissezione

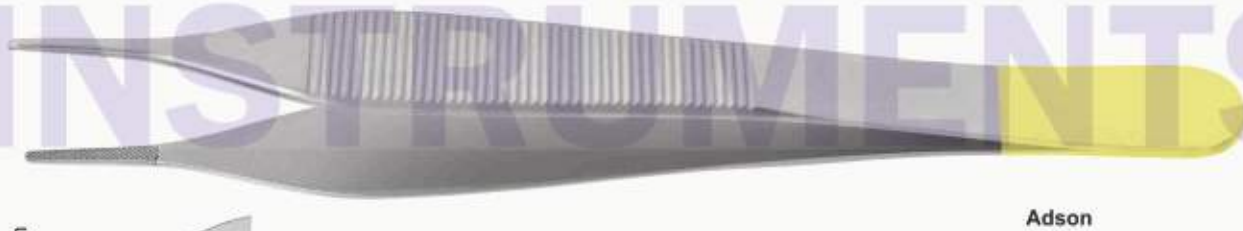

TISSUE & DRESSING FORCEPS T.C

Pincas a tissu, Anatomische pinzetten
Gewebe, Pinzas de disección

Pinzas para tejidos, Pincas à dissection
Pinze per tessuti, Pinze per dissezione



Micro Adson
Light Weight

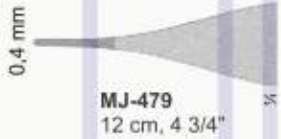

Adson
Light Weight



Adson
Light Weight



Pincas a tissu, Anatomische pinzetten | *Pinzas para tejidos, Pincas à dissection*
Gewebe, Pinzas de disección | *Pinze per tessuti, Pinze per dissezione*



*Pinces a tissu, Anatomische pinzetten
Gewebe, Pinzas de disección*

*Pinzas para tejidos, Pinces à dissection
Pinze per tessuti, Pinze per dissezione*



Micro Adson
Light Weight
1x2 teeth



Adson
Light Weight
1x2 teeth



Adson-Brown
Light Weight
3x4 teeth

Pinces a tissu, Anatomische pinzetten
Gewebe, Pinzas de disección

Pinzas para tejidos, Pinces à dissection
Pinze per tessuti, Pinze per dissezione



T.C Standard Dressing Forceps



0,4 mm
MJ-494
14 cm, 5 ½"

0,4 mm
MJ-495
16 cm, 6 ¼"



T.C Cushing Tissue Forceps
MJ-496 17.8 cm, 7"



T.C Cushing Dressing Forceps
MJ-497
18 cm, 7" Cross Serrated



T.C Cushing Dressing Forceps
MJ-498 18 cm, 7"



INSTRUMENTS

Pinces a tissu, Anatomische pinzetten
Gewebe, Pinzas de disección

Pinzas para tejidos, Pinces à dissection
Pinze per tessuti, Pinze per dissezione



T.C Dissecting Tissue Forceps
MJ-499 18 cm, 7"



T.C Resano Dressing Forceps
MJ-500
25 cm, 10"



T.C Cushing Dressing Forceps
MJ-501
19 cm, 7 1/2"

INSTRUMENTS

TISSUE & DRESSING FORCEPS T.C

Pinces a tissu, Anatomische pinzetten
Gewebe, Pinzas de disección

Pinzas para tejidos, Pinces à dissection
Pinze per tessuti, Pinze per dissezione

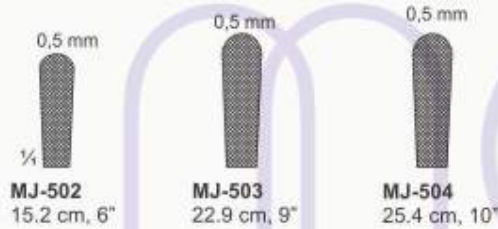

Wangensteen Dressing Forceps T.C.



T.C DeBakey Micro Needle Tissue Forceps
MJ-505
18.4 cm, 7"



T.C Bonney Dissecting & Tissue Forceps

INSTRUMENTS

TISSUE & DRESSING FORCEPS T.C

*Pinces a tissu, Anatomische pinzetten
Gewebe, Pinzas de disección*

*Pinzas para tejidos, Pinces à dissection
Pinze per tessuti, Pinze per dissezione*



0,4 mm



**T.C POTTS-SMITH
Dressing Forceps**
MJ-509 15 cm, 6"
MJ-510 18 cm, 7"
MJ-511 20 cm, 8"
MJ-512 23 cm, 9"
MJ-513 25 cm, 10"



0,4 mm



**T.C POTTS-SMITH
Dressing Forceps**
MJ-514 16 cm, 6 1/2"
MJ-515 18 cm, 7"
MJ-516 21 cm, 8 1/2"
MJ-517 24 cm, 9 1/2"
MJ-518 26 cm, 10 1/2"



0,4 mm



**T.C Evans Pelvic Needle
Dressing Forceps**
MJ-519
25.4 cm, 10"



0,4 mm



**T.C Evans Dressing
Forceps**
MJ-520
25 cm, 10"



0,4 mm



**T.C Mc Indoe Dressing
Forceps**
MJ-521
15.0 cm 6"

INSTRUMENTS

DRESSING FORCEPS T.C.

Anatomische pinzetten | Pincés à dissection
Pinzas de disección | Pinze per dissezione

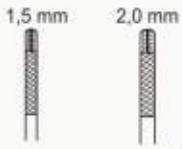

T.C De Bakey Dressing Forceps
MJ-522 15.0 cm 6"
MJ-523 19.0 cm 7 1/2"
MJ-524 24.0 cm 9 1/2"



T.C Gillies Tissue Forceps
MJ-525
15.0 cm 6"



SEMKEN
with dissector end
MJ-526
15 cm, 6"



SEMKEN
1x2 teeth

MJ-527
16 cm, 6 1/4"

MJ-528
18 cm, 7"

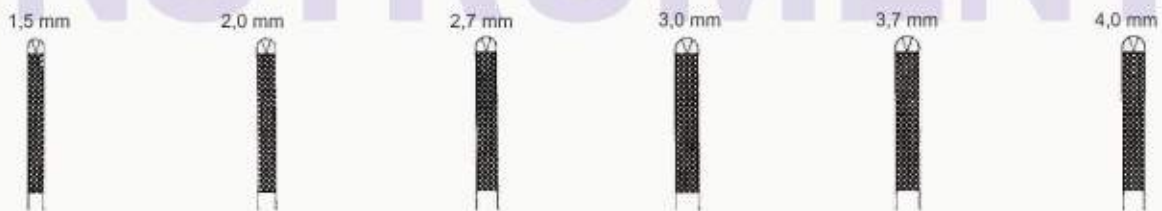

T.C Oehler Tissue Forceps

MJ-529
14.0 cm 5 1/2"

MJ-530
16.0 cm 6 1/4"

MJ-531
18.0 cm 7"

MJ-532
20.0 cm 8"

MJ-533
25.0 cm 9 3/4"

MJ-534
30.0 cm 12"

INSTRUMENTS

Approximatoren, Gefäßclips nach Biemer
Approximateurs, clips selon Biemer

Approximadores, Biemer clips
Approssimatori, clips vascolari Biemer



Diethrich Micro-Corony Bulldog Clamps
5.0 cm 2"
straight

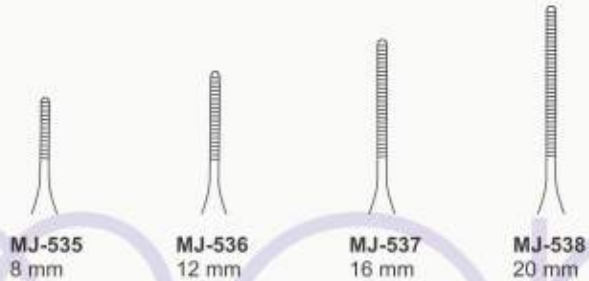

MJ-535 8 mm
MJ-536 12 mm
MJ-537 16 mm
MJ-538 20 mm



Diethrich Micro-Corony Bulldog Clamps
5.0 cm 2", angled jaws

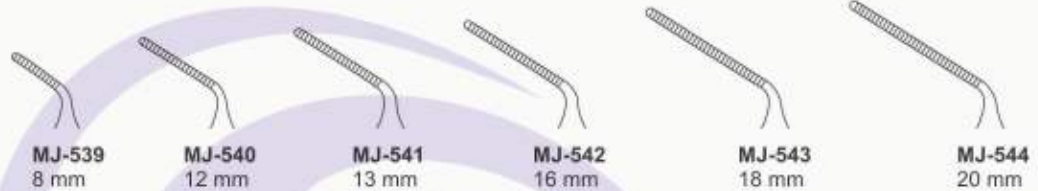

MJ-539 8 mm
MJ-540 12 mm
MJ-541 13 mm
MJ-542 16 mm
MJ-543 18 mm
MJ-544 20 mm



Cooley Cross Action Bulldog Clamp

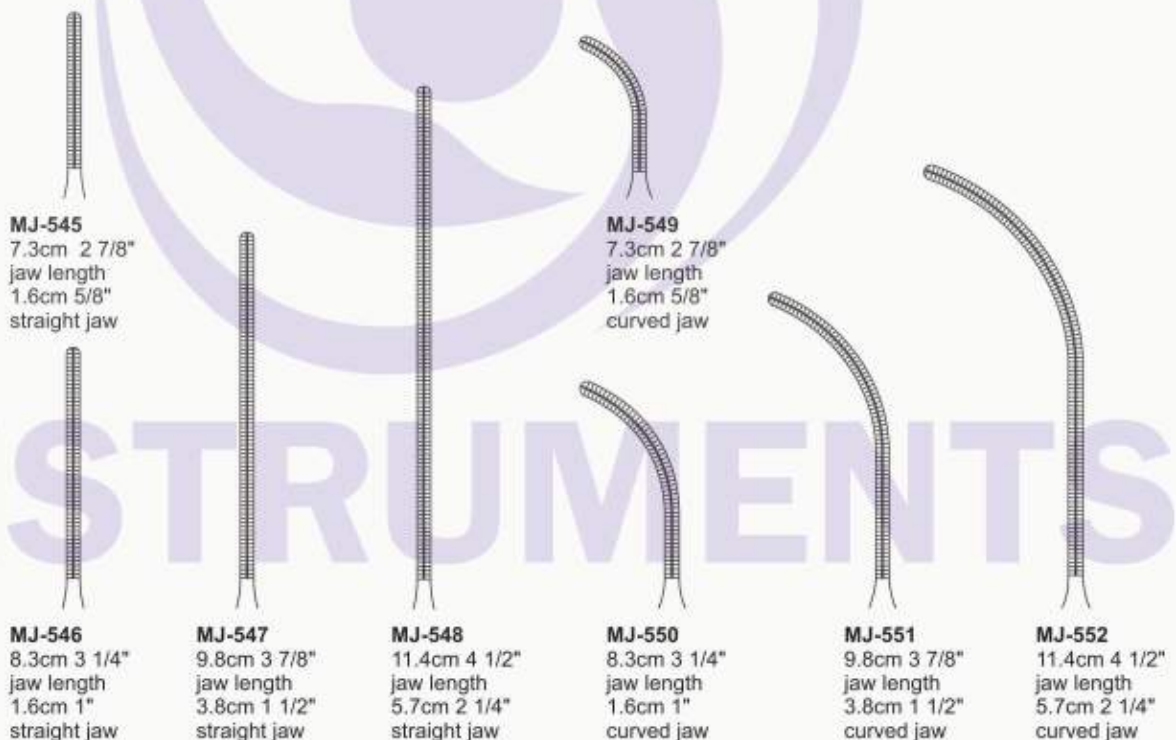

MJ-545
7.3cm 2 7/8"
jaw length
1.6cm 5/8"
straight jaw

MJ-546
8.3cm 3 1/4"
jaw length
1.6cm 1"
straight jaw

MJ-547
9.8cm 3 7/8"
jaw length
3.8cm 1 1/2"
straight jaw

MJ-548
11.4cm 4 1/2"
jaw length
5.7cm 2 1/4"
straight jaw

MJ-549
7.3cm 2 7/8"
jaw length
1.6cm 5/8"
curved jaw

MJ-550
8.3cm 3 1/4"
jaw length
1.6cm 1"
curved jaw

MJ-551
9.8cm 3 7/8"
jaw length
3.8cm 1 1/2"
curved jaw

MJ-552
11.4cm 4 1/2"
jaw length
5.7cm 2 1/4"
curved jaw

Bulldogklemmen	Clamps Bulldog
Clamps Bulldog	Pinze Bulldog



De Bakey Bulldog Clamp straight cross action



MJ-553
75 mm 3"
jaw length 2cm



MJ-554
85 mm 3 1/4"
jaw length 3cm



MJ-555
105 mm 4 1/4"
jaw length 4.5cm



MJ-556
120 mm 4 3/4"
jaw length 6.5cm



De Bakey Bulldog Clamp curved cross action



MJ-557
70 mm 2 3/4"
jaw length 2cm

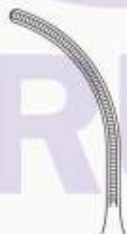

MJ-558
80 mm 3 1/4"
jaw length 3cm



MJ-559
100 mm 4"
jaw length 4.5cm



MJ-560
115 mm 4 1/2"
jaw length 6.5cm



MJ-561
55 mm 2 1/4"
angled on flat

Approximateurs, Gefäßclips nach Biemer
Approximateurs, clips selon Biemer

Approximadores, Biemer clips
Approssimatori, clips vascolari Biemer



Glover Atrauma Bulldog Clamps
cooley serrations with adjusting screw to regulate tension, Straight



MJ-562
5cm, jaw length 1.8cm



MJ-563
6.5cm, jaw length 3.2cm



MJ-564
8.4cm, jaw length 4.5cm



MJ-565
12cm, jaw length 6cm



Glover Atrauma Bulldog Clamps
cooley serrations with adjusting screw to regulate tension, curved



MJ-566
5cm, jaw length 1.8cm



MJ-567
6.5cm, jaw length 3.2cm



MJ-568
8.4cm, jaw length 4.5cm



MJ-569
12cm, jaw length 6cm



MJ-570
50 mm 2" jaw length 3.1cm, angled on flat

Approximatoren, Gefäßclips nach Biemer
Approximateurs, clips selon Biemer

Approximadores, Biemer clips
Approssimatori, clips vascolari Biemer



Cooley Atrauma Bulldog Clamps
cooley serrations with adjusting screw to regulate tension, Straight



MJ-571
5.1cm, jaw length 2cm



MJ-572
6.7cm, jaw length 3cm



MJ-573
8.6cm, jaw length 4.7cm



MJ-574
13.3cm, jaw length 6cm



Cooley Atrauma Bulldog Clamps
cooley serrations with adjusting screw to regulate tension, curved



MJ-575
4.4cm, jaw length 1.8cm



MJ-576
6.4cm, jaw length 2.4cm

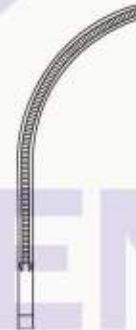

MJ-577
7.6cm, jaw length 4cm

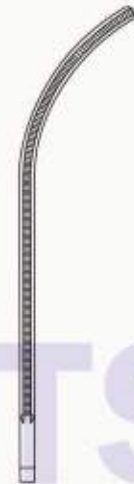

MJ-578
12.4cm, jaw length 5.2cm

Bulldogklemmen	Clamps Bulldog
Clamps Bulldog	Pinze Bulldog



De Bakey Atraumatic Bulldog Clamps Satinsky
MJ-579
7.0 cm 2 3/4"

De Bakey Atraumatic Bulldog Clamps Carotis
MJ-580
9.0 cm 3 1/2"

De Bakey Atraumatic Bulldog Clamps Satinsky
MJ-581
10.0 cm 4"



Santulli Atraumatic Bulldog Clamps
MJ-582
7.0 cm 2 3/4"

Gregory-Soft Atraumatic Bulldog Clamps

MJ-583
9.0 cm 3 1/2"

MJ-584
11.0 cm 4 1/4"

INSTRUMENTS

ATRAUMATIC TISSUE FORCEPS

Atraumatische Pinzetten | Pinzas atraumáticas de disección
Pincas Atraumatiques | Pinze atraumatiche per disseziobe



x=1.5 mm		x=2.0 mm		x=2.7 mm		x=3.5 mm	
MJ-585	12.0 cm 4 ¾"	MJ-590	14.5 cm 5 ¾"	MJ-595	16.0 cm 6 ¼"	MJ-599	16.0 cm 6 ¼"
MJ-586	14.5 cm 5 ¾"	MJ-591	16.0 cm 6 ¼"	MJ-596	20.0 cm 8"	MJ-600	20.0 cm 8"
MJ-587	16.0 cm 6 ¼"	MJ-592	20.0 cm 8"	MJ-597	24.0 cm 9 ½"	MJ-601	24.0 cm 9 ½"
MJ-588	20.0 cm 8"	MJ-593	24.0 cm 9 ½"	MJ-598	30.0 cm 12"	MJ-602	30.0 cm 12"
MJ-589	24.0 cm 9 ½"	MJ-594	30.0 cm 12"			MJ-603	35.0 cm 14"

x=1.5 mm
MJ-604
14.5 cm 5 ¾"
Angled

x=2.0 mm
MJ-605
16.0 cm 6 ¼"
MJ-606 20.0 cm 8"
MJ-607 24.0 cm 9 ½"
MJ-608 30.0 cm 12"
Angled

De Bakey Atraumatic
Tissue Clamp Forceps

INSTRUMENTS

ATRAUMATIC TISSUE FORCEPS

Atraumatische Pinzetten
Pinces Atraumatiques

Pinzas atraumáticas de disección
Pinze atraumatiche per disseziobè



De Bakey
Atraumatic Tissue
Clamp Forceps
Titanium



De Bakey
Atraumatic Tissue
Clamp Forceps



INSTRUMENTS

Adson Tissue Forceps Titanium
1.0mm tips / 4 3/4" (12cm)
MJ-636T TC dust
MJ-637T Tying Platform



Adson-Harris Forceps Titanium
Fenestrated / ring-tip /
TC dust / 4 3/4" (12cm)
MJ-638T



Adson Tissue Forceps Titanium
1 x 2 Teeth / 5 7/8" (15cm)
MJ-639T



Brown Adson Tissue Forceps Titanium
1.8 mm tips / 7x7 teeth / 4 3/4" (12cm)
MJ-640T



Troutman Micro Hook Forceps Titanium
with Tying Platform / TC dust / round Handle
MJ-641T



McPherson Forceps
MJ-642



McPherson Forceps
MJ-643



Suture Tying Forceps
MJ-644

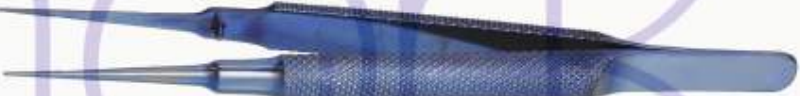

Suture Tying Forceps
MJ-645



Utrata Capsulorhexis Forceps
MJ-646



Utrata Capsulorhexis Forceps
MJ-647



Corneal Forceps 1x2 (0.12)
MJ-648



Corneal Forceps 1x2 (0.12)
MJ-649



DeBekay Forceps
MJ-650
5.5"



DeBekay Forceps
MJ-651
5.5"



Serrated Curved Forceps
with lock
MJ-652
5.5"



INSTRUMENTS

MJ-653
Chalazion Clamp



MJ-654
Morefeld Forceps
4.25"



MJ-655
Colibri Forceps
1 x 2 (0.12)



MJ-656
Bound Handle



MJ-657



MJ-658
Suture Tying Forceps
4.25"



MJ-659
Suture Tying Forceps
3.5"



MJ-660
McPherson Forceps
4.25"



MJ-661
McPherson Forceps
3.5"



MJ-662
Corneal Forceps
1 x 2 (0.12)
4.25"



MJ-663
Corneal Forceps
1 x 2 (0.12)
3.5"



MJ-664
Bonn Forceps
1 x 2 (0.12)
4.25"



MJ-665
Utrata Capsulorhexis
Forceps
4.25" Curved



MJ-666
Utrata Capsulorhexis
Forceps
4.25" Straight



INSTRUMENTS



CEMARK
Approved



MARK INSTRUMENTS (PVT) LTD.

Manufacturers and Exporters of High Class Surgical, Dental Instruments.

Registered office: 26/4-Zafar Ali Road, Sialkot-Cantt. 51310-Pakistan.
Tel: +92-52-4292513-19 (2 Lines), Fax: +92-52-4268742 Cell: +92-300-8612950
E-mail: info@markinstruments.com Web: www.markinstruments.com